

ARSANY 45 G-72 1F

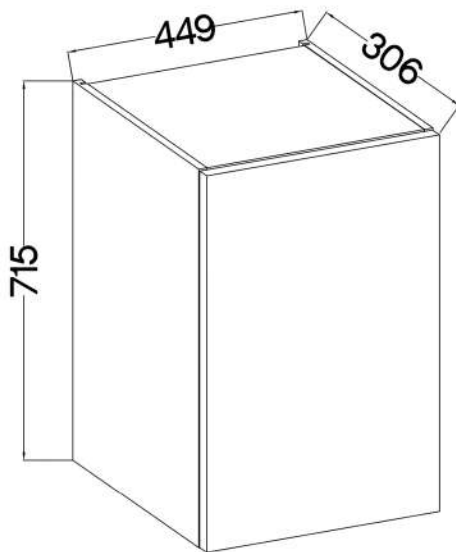

KUH.30039
KUH.40065

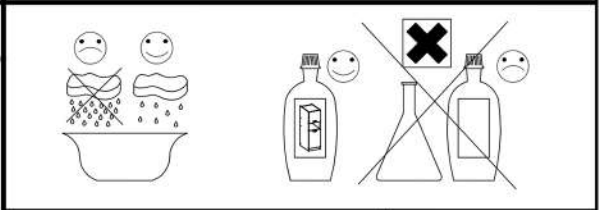

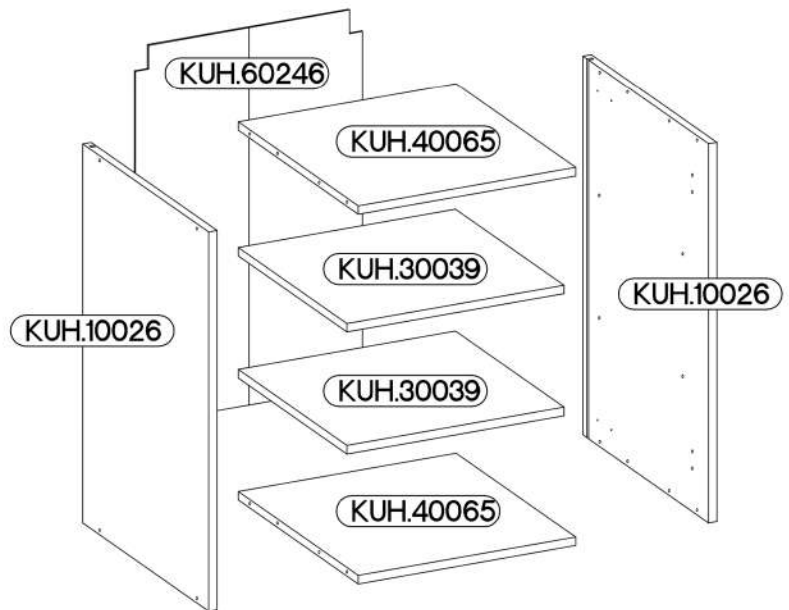
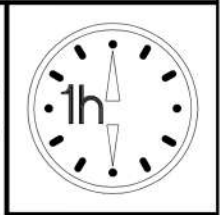

KUH.10026 x2	715x290x16
KUH.30039 x2	416x250x16
KUH.40065 x2	417x276x16
KUH.60246	713x435x2,5

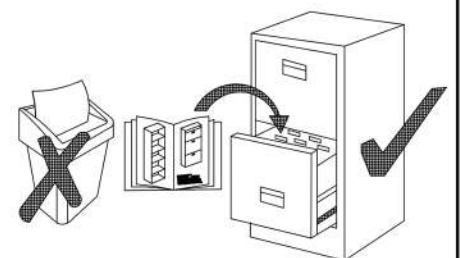
 A 8	 B 8	 E1 8	 HG 2	 J 8	 K 2	 O 1	 P5 4	 P7 8-10	 P8 4
†8x30mm	6,4 x 50mm		†35/0mm	†5/19mm			†3.5x13mm	†3.0x20mm	†4.0x30mm



1

 A	 P8	 K
8	4	2

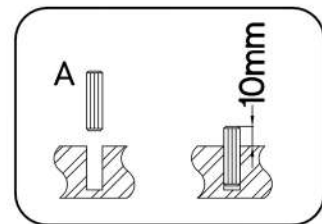
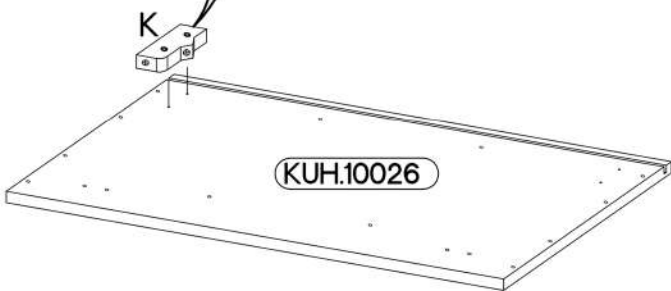
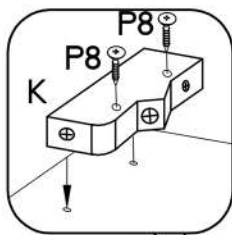
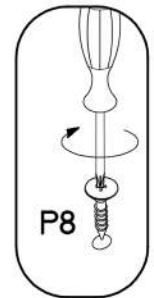
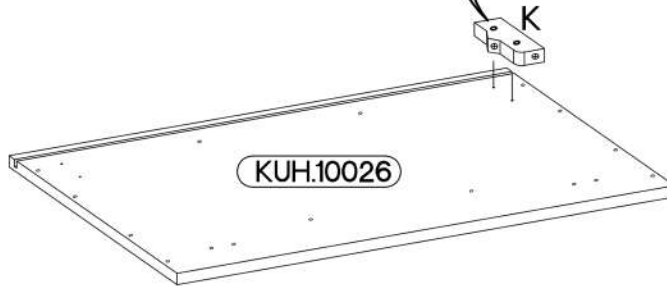
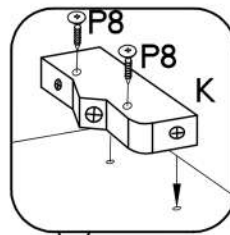
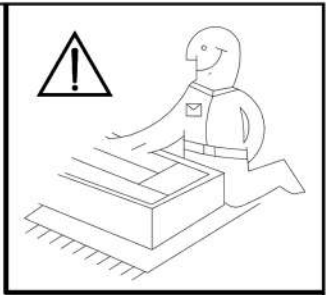

2

6,4 x 50mm

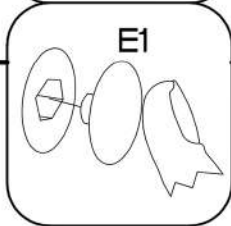
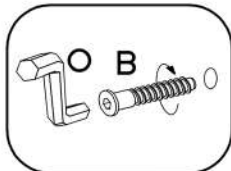
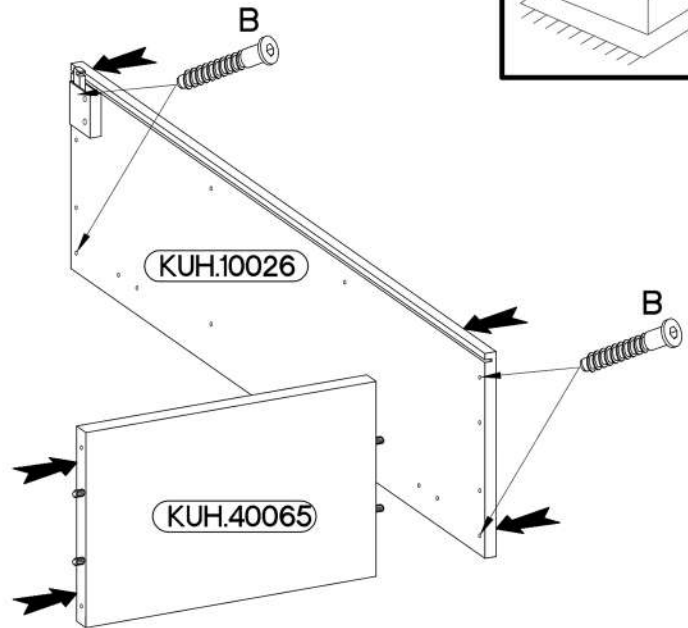
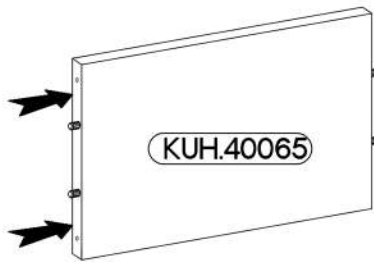
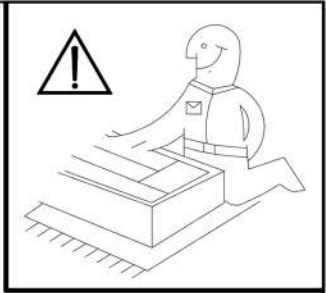
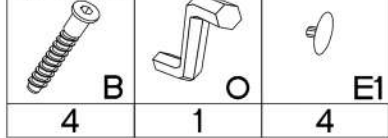

3

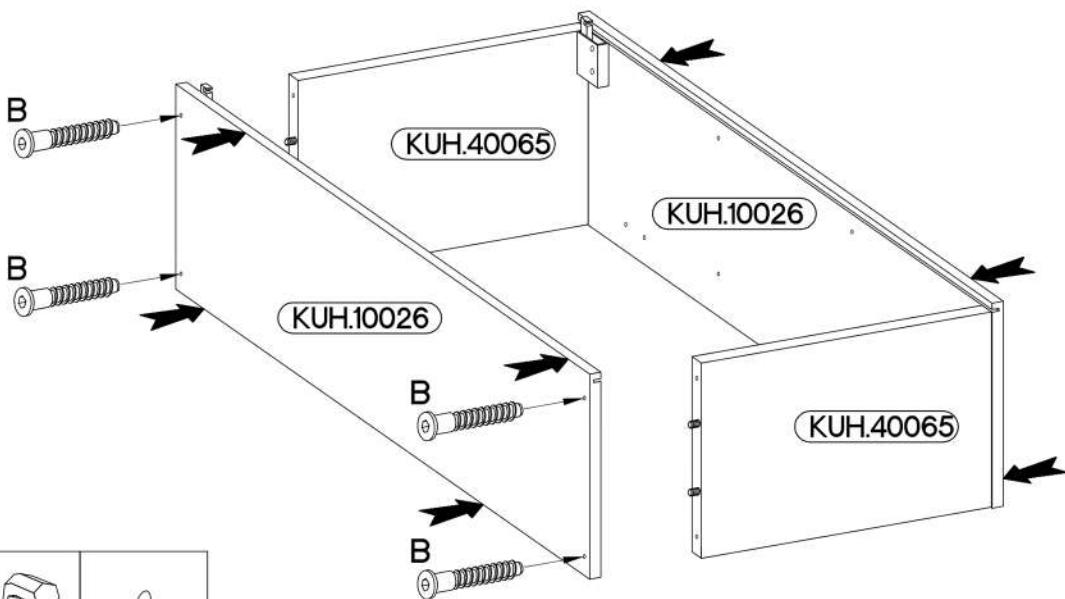

6,4 x 50mm

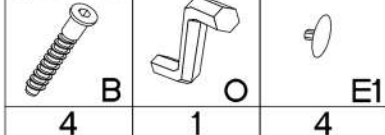

4

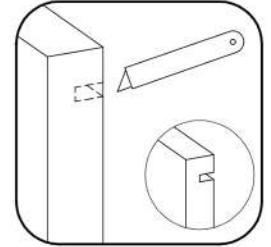
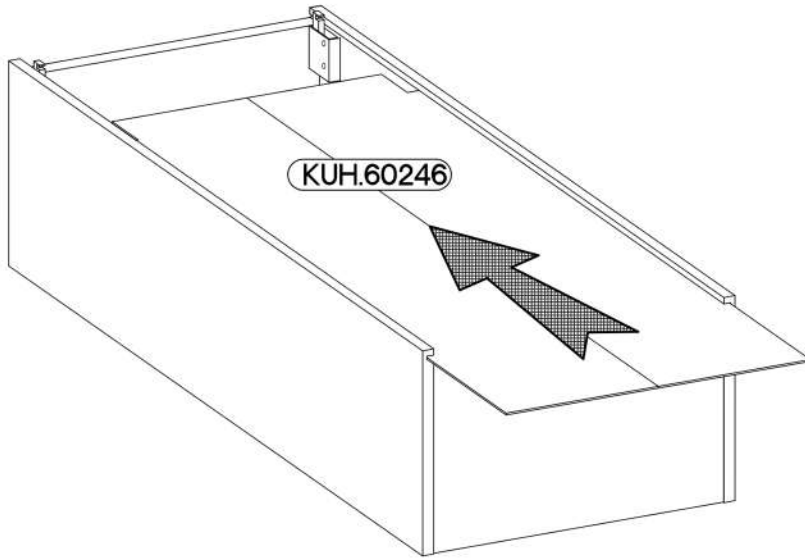
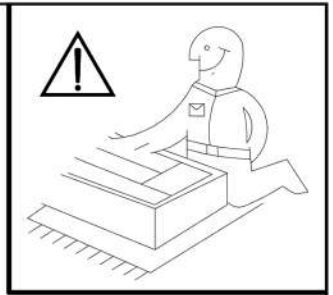

5

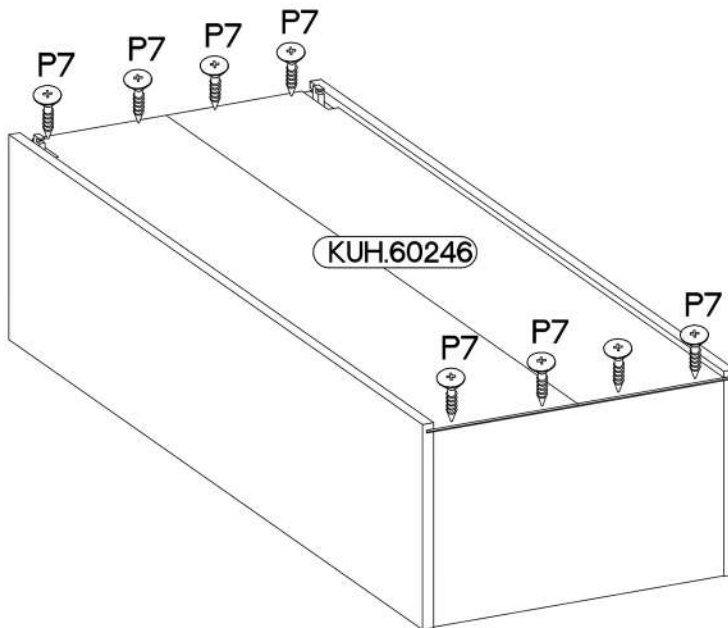
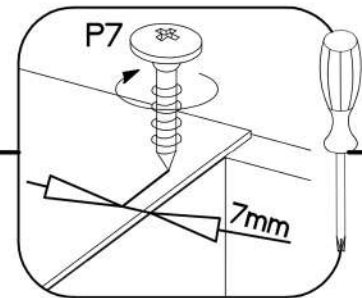
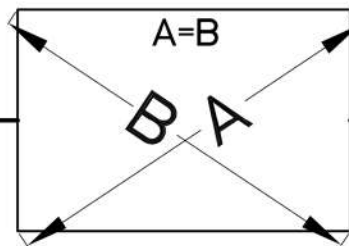
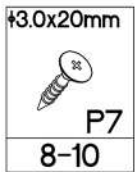

6

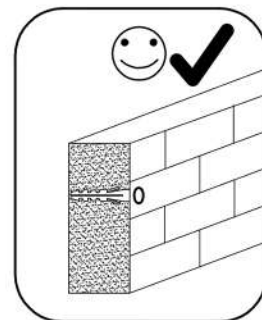
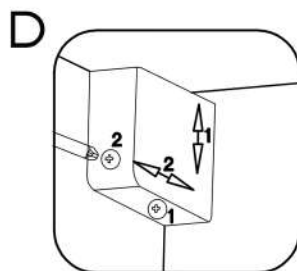
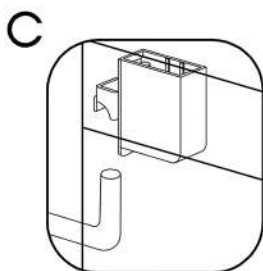
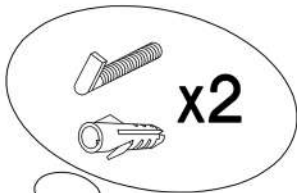
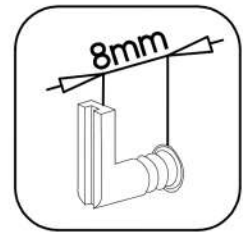
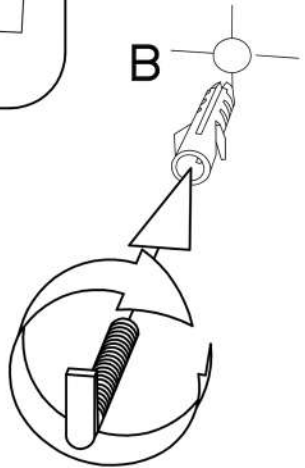
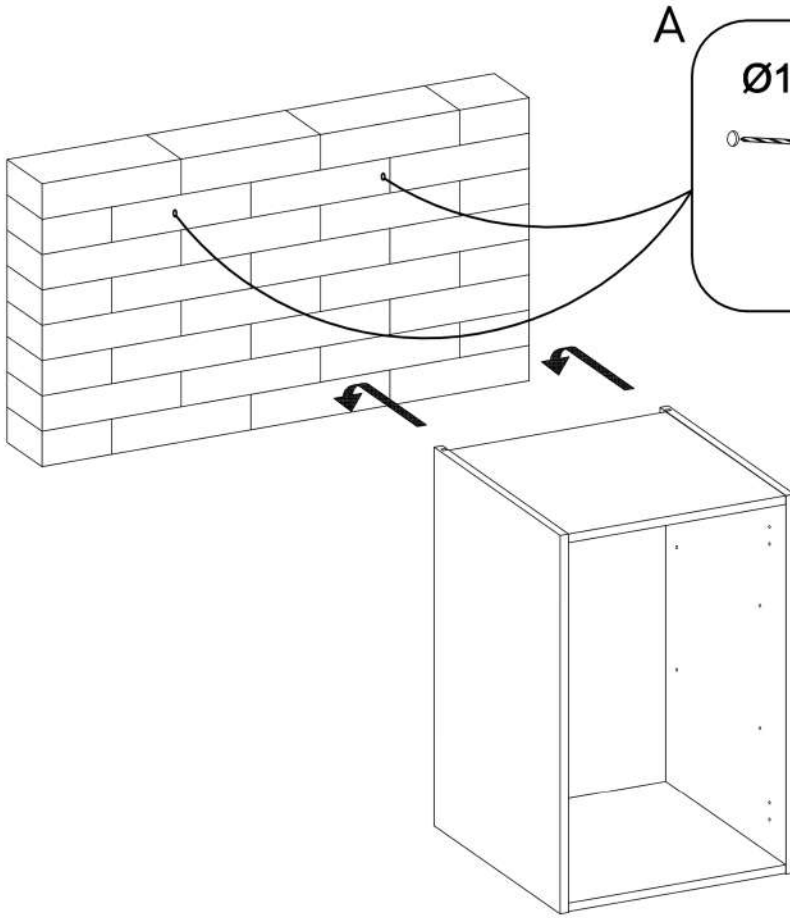
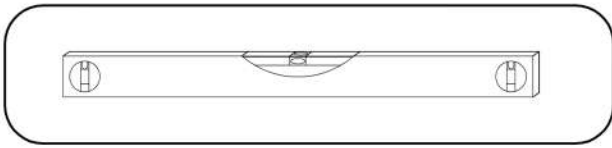

7

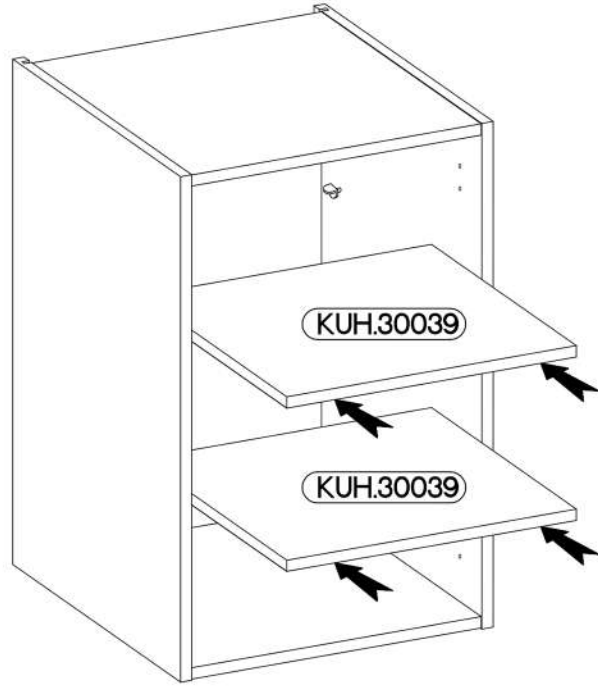
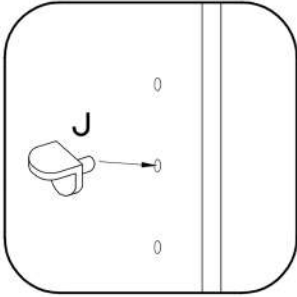
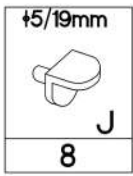

8

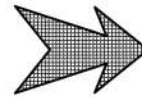
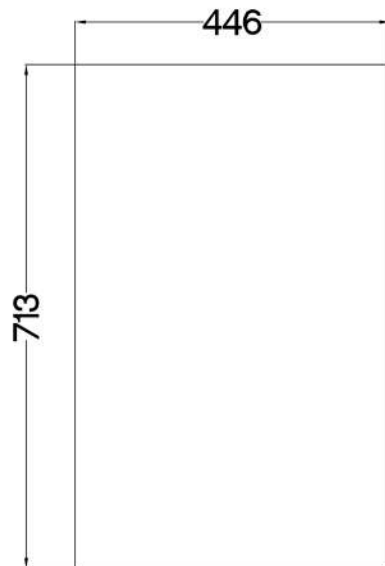

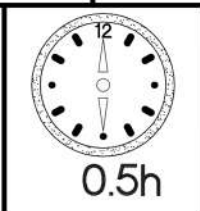
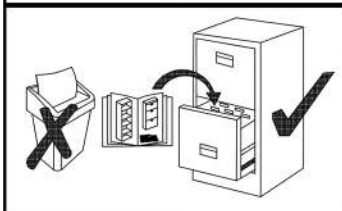
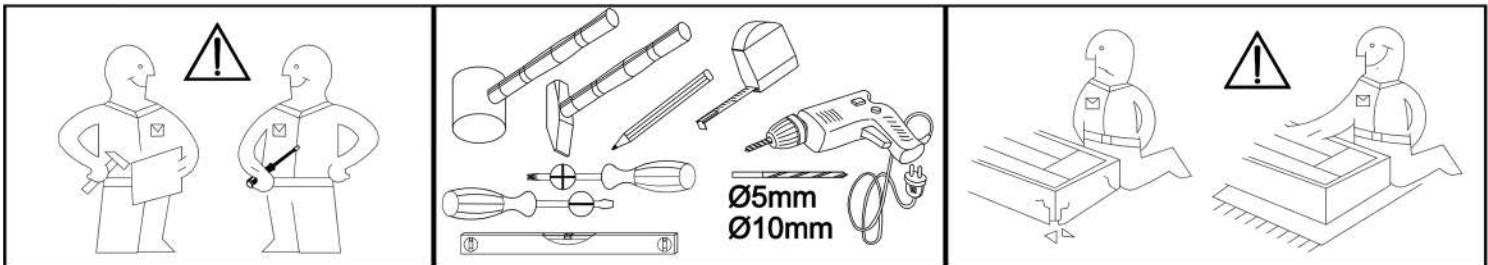

713x446

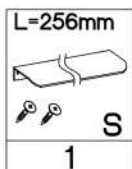
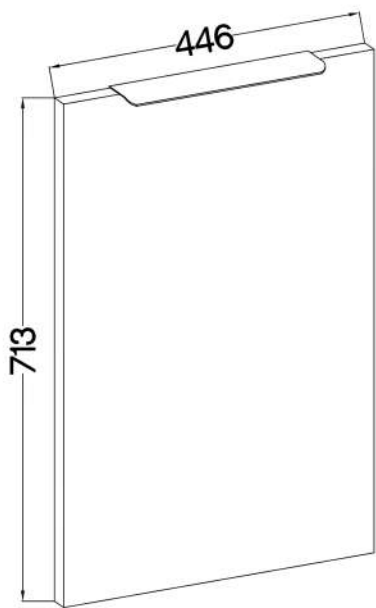
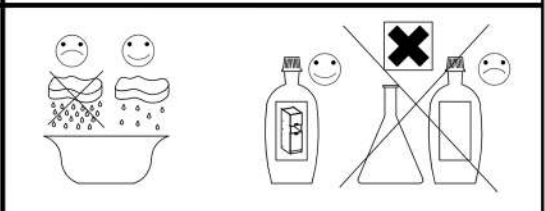

KUH.71179 713x446x16

1

1

L=256mm



S

1

