

ARSANY 50 G-108 1F

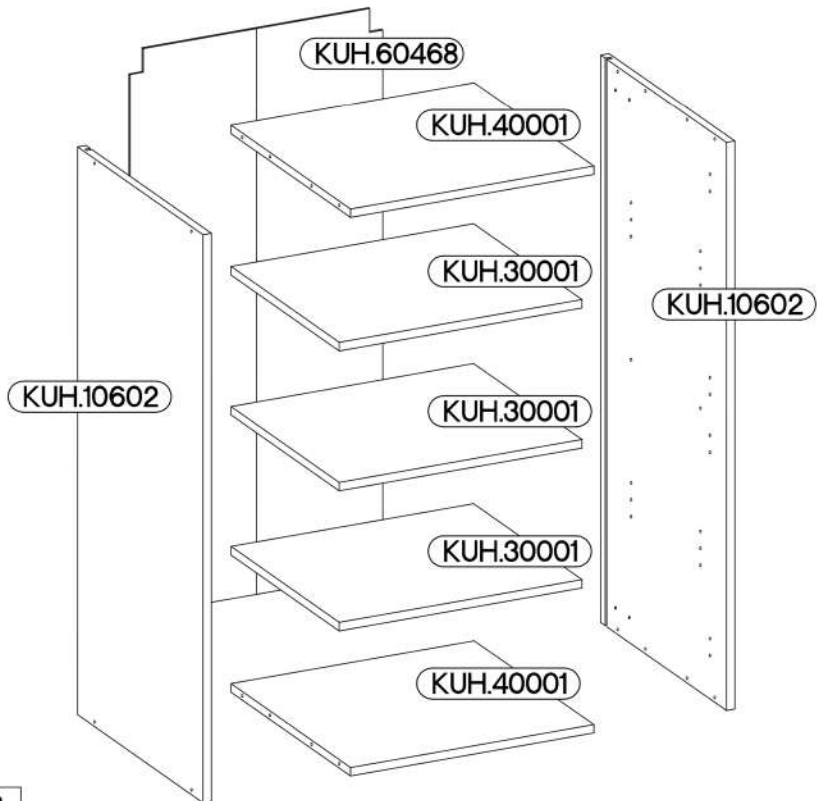

KUH.10602 x2	1073x290x16
KUH.30001 x3	466x250x16
KUH.40001 x2	467x276x16
KUH.60468	1070x485x2,5

$\pm 8 \times 30 \text{mm}$ A	$6,4 \times 50 \text{mm}$ B		$\pm 35/0 \text{mm}$ HG			
8	8	8	3			
$\pm 5/16 \text{mm}$ J3			$\pm 3.5 \times 13 \text{mm}$ P5	$\pm 3.0 \times 20 \text{mm}$ P7	$\pm 4.0 \times 30 \text{mm}$ P8	
12	2	1	6	8-10	4	

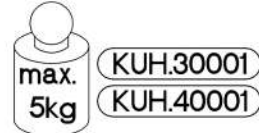
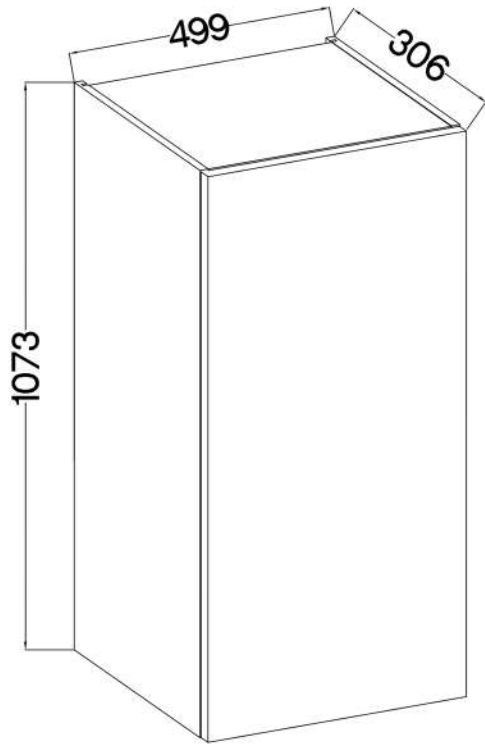
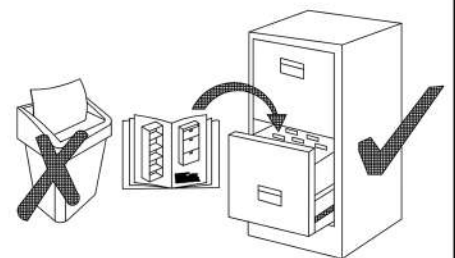

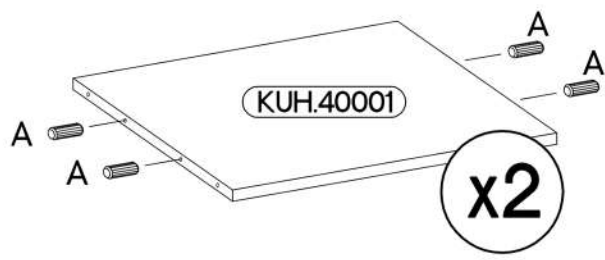
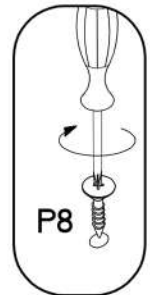
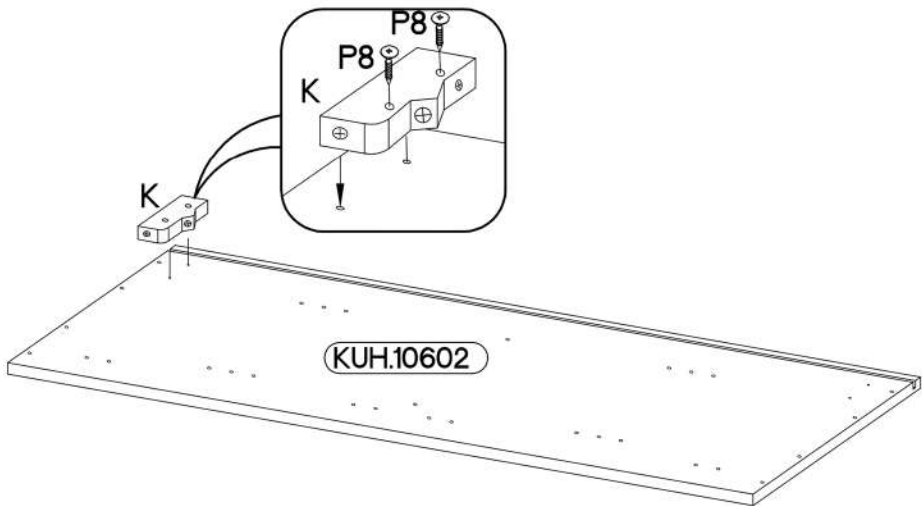
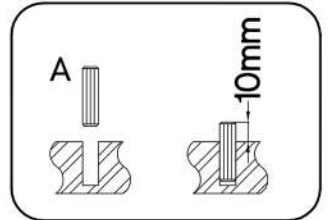
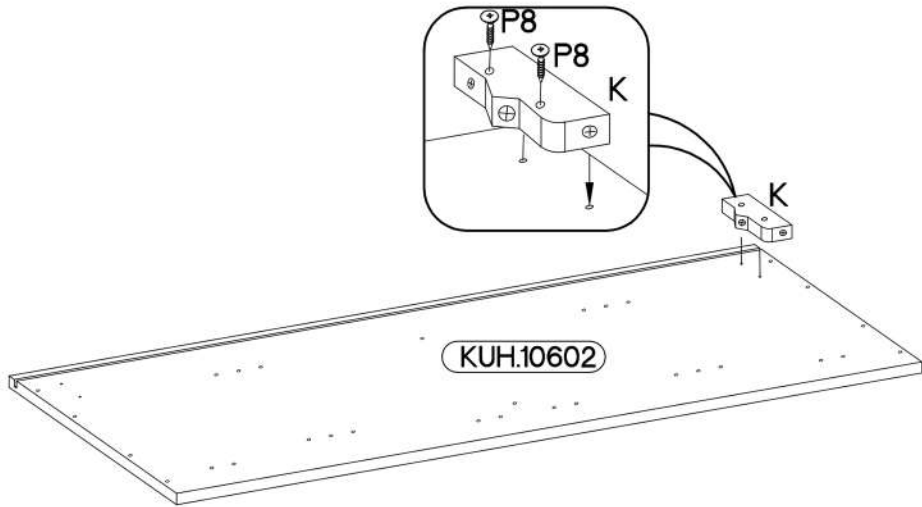
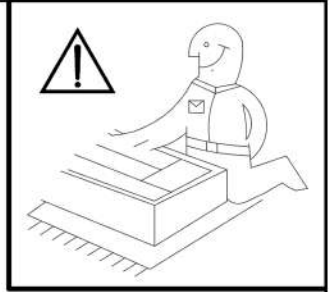

1

±8x30mm A 8	±4.0x30mm P8 4	K 2
-------------------	----------------------	--------





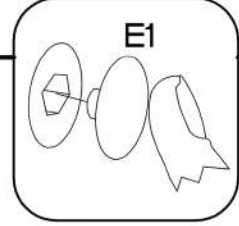
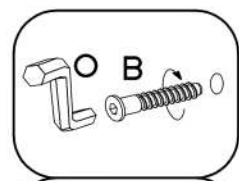
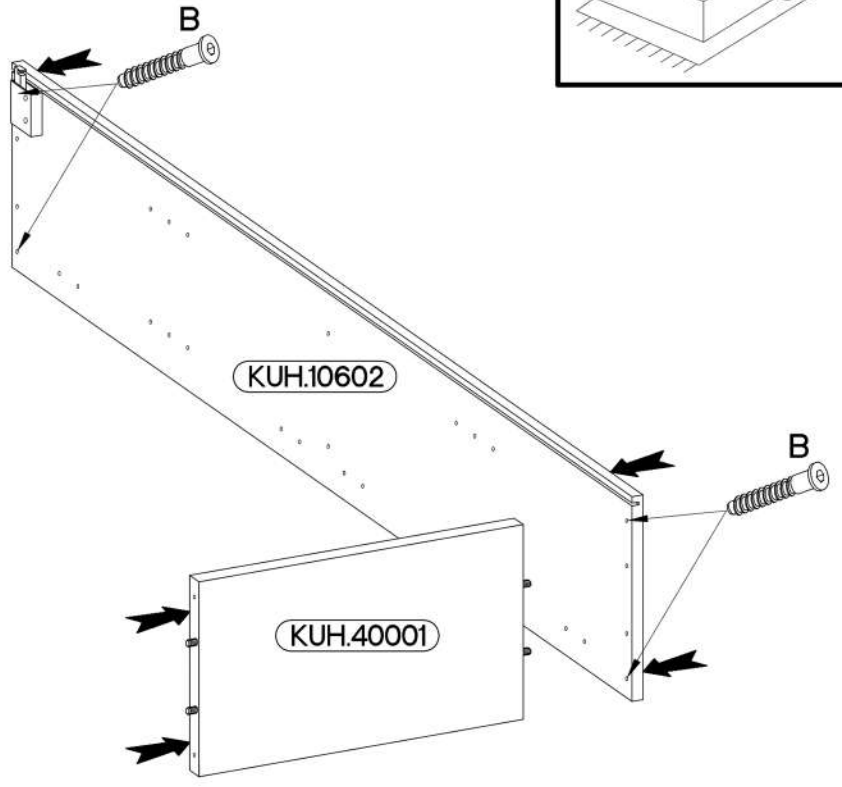
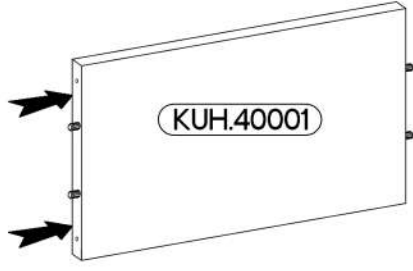
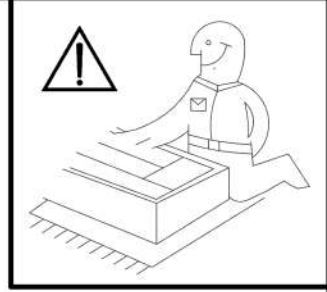

2

6,4 x 50mm		
		
B	O	E1
4	1	4

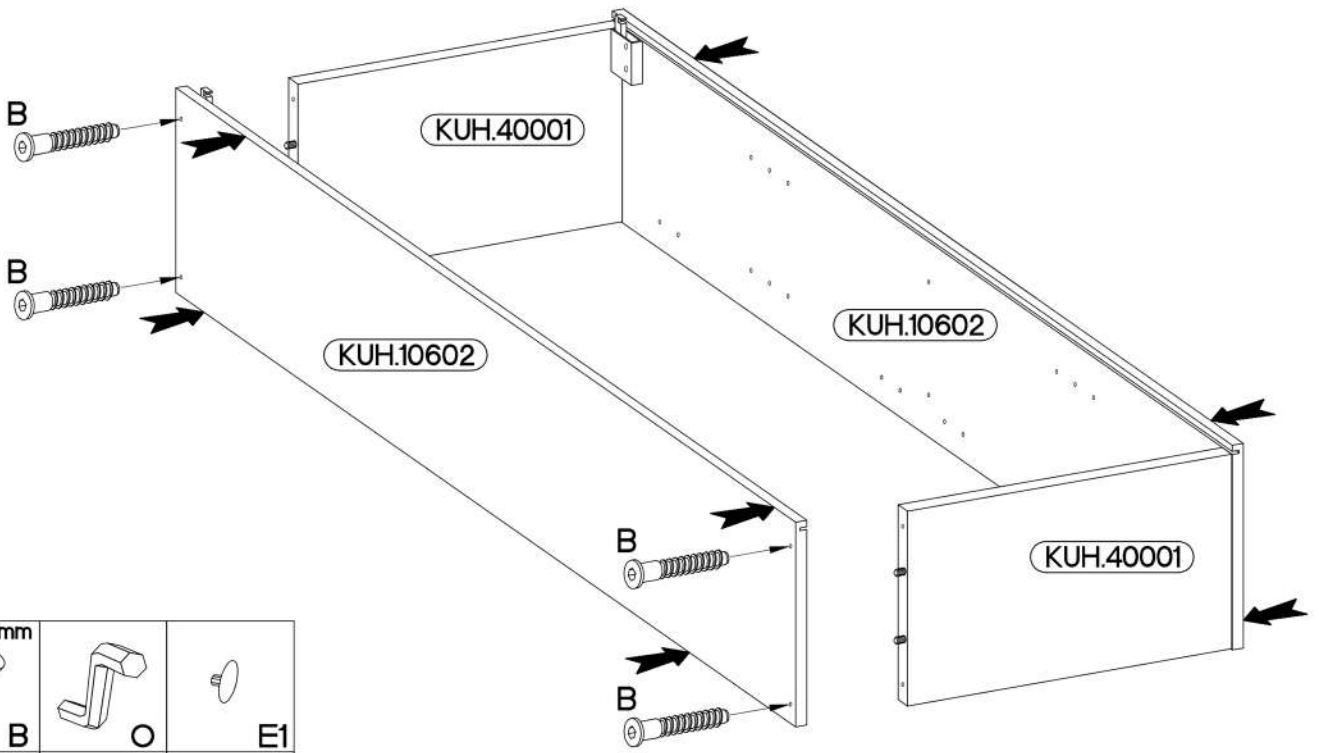

3



6,4 x 50mm		
		
B	O	E1
4	1	4

4

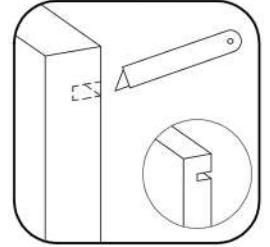
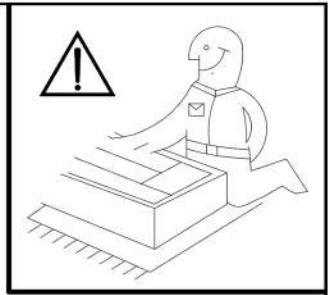
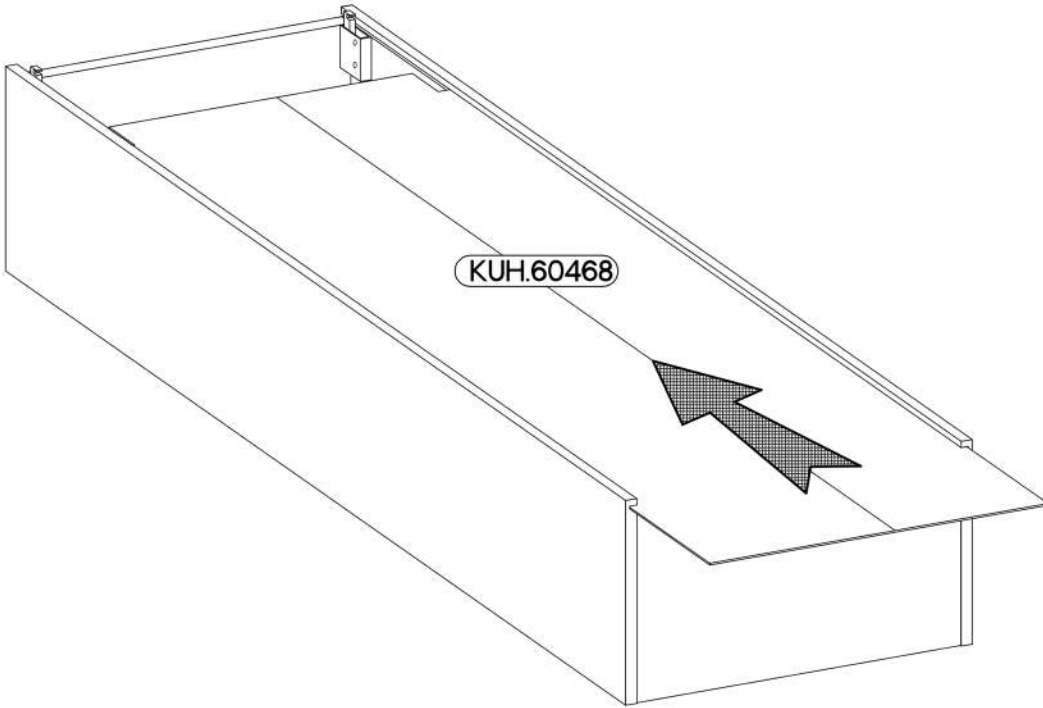

5

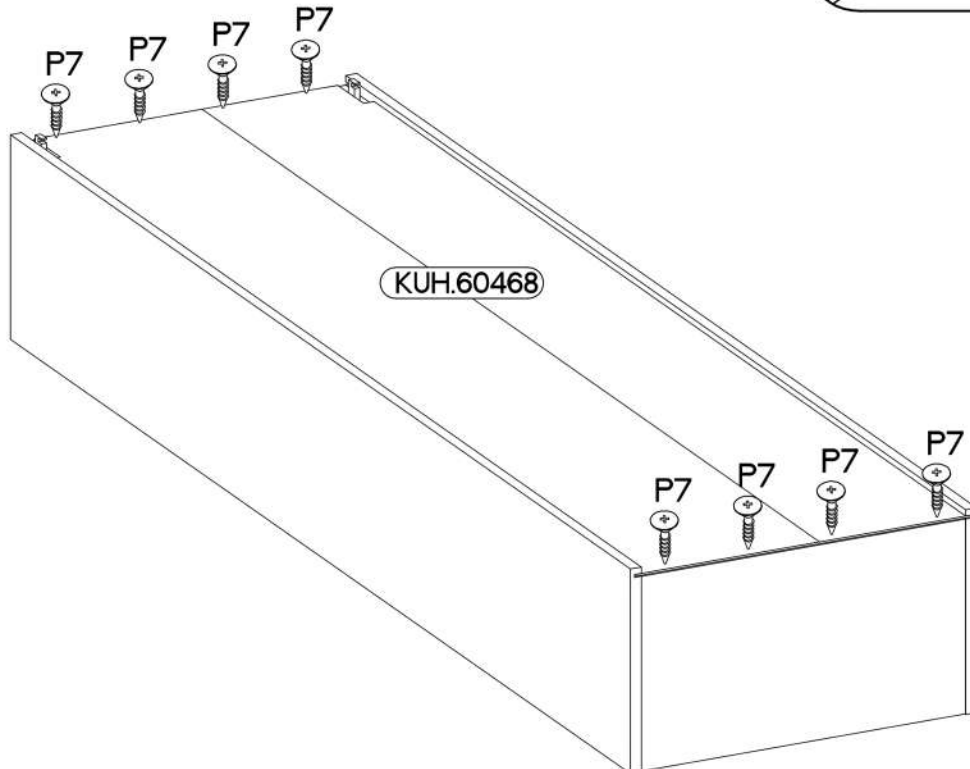
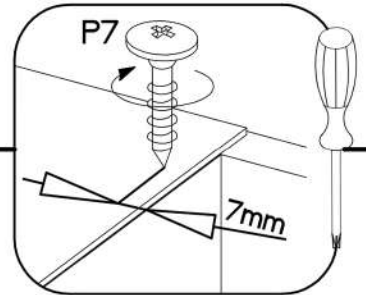
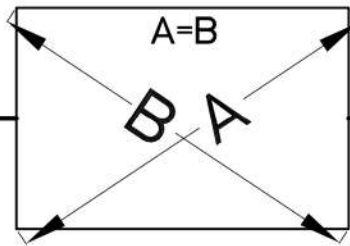

6

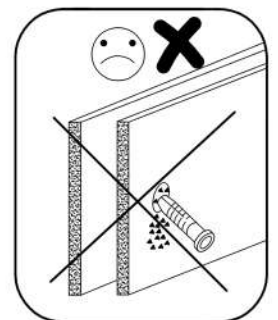
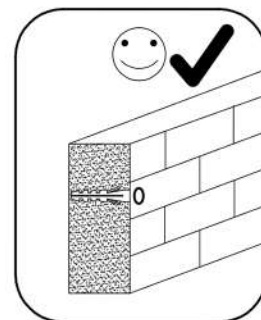
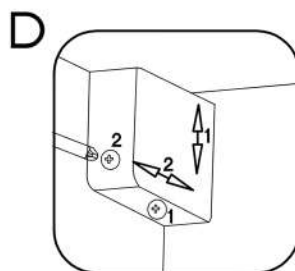
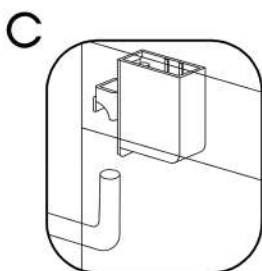
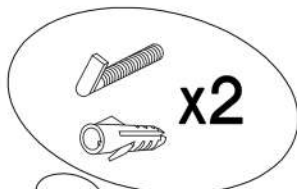
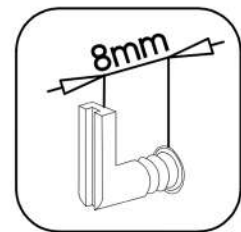
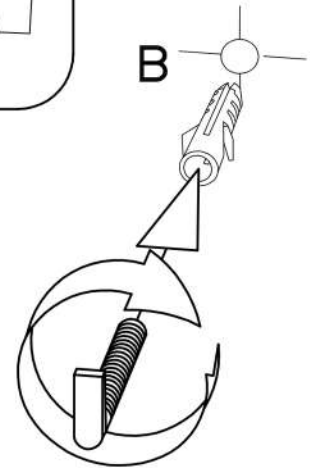
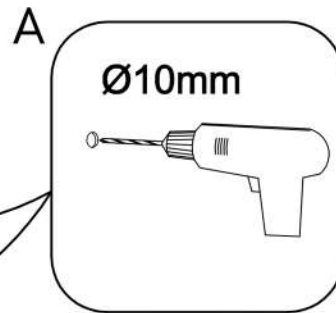
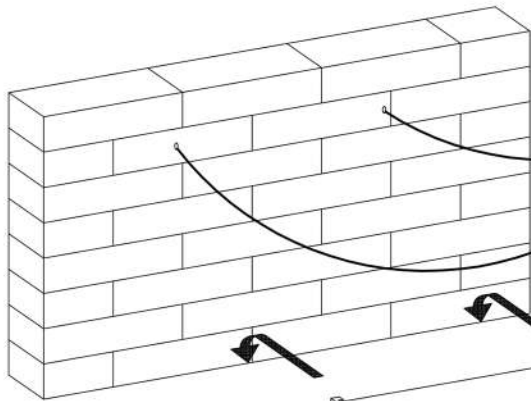
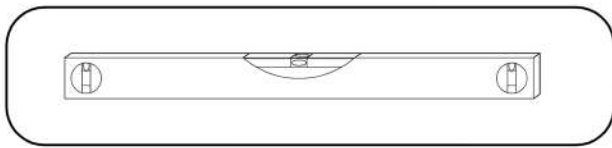

7

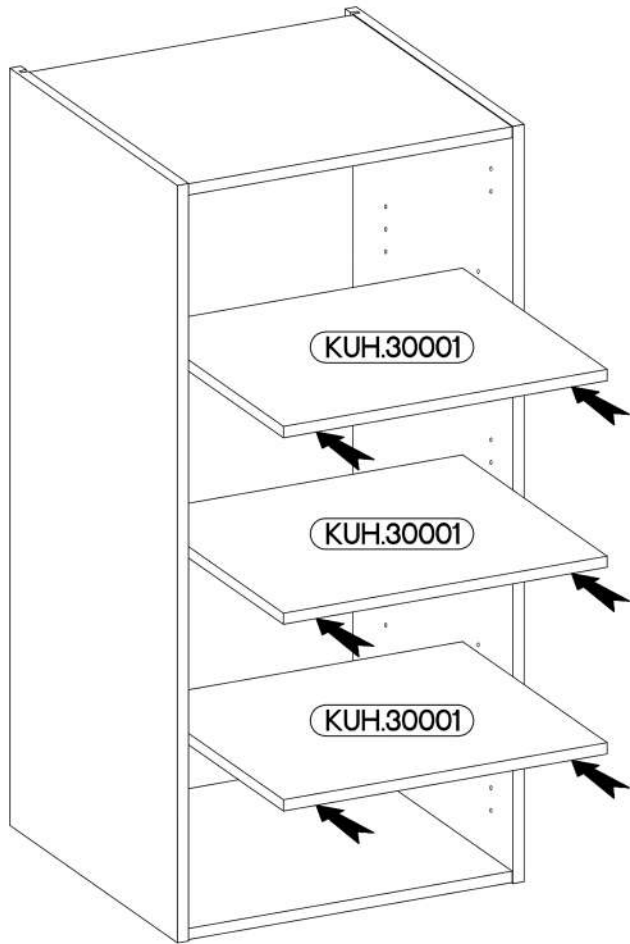
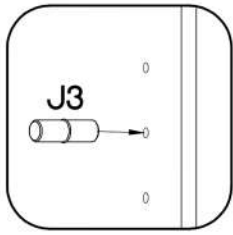
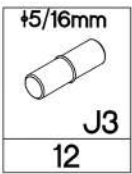

8

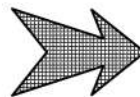
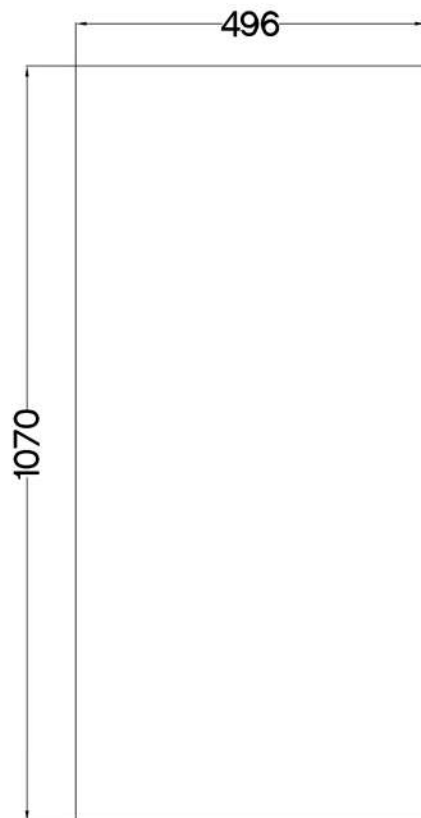

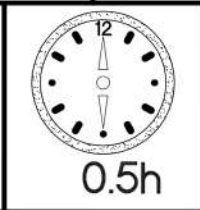
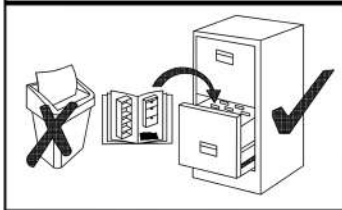
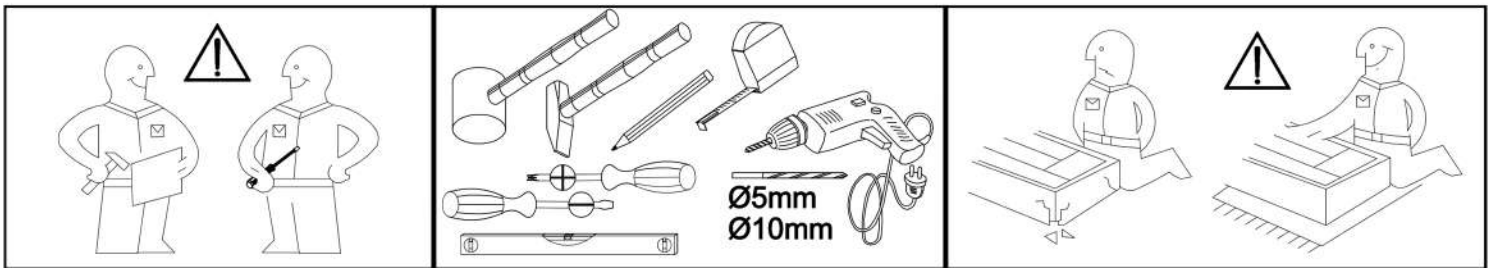

1070x496

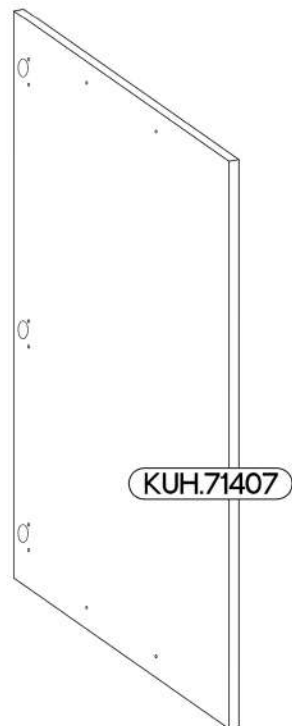
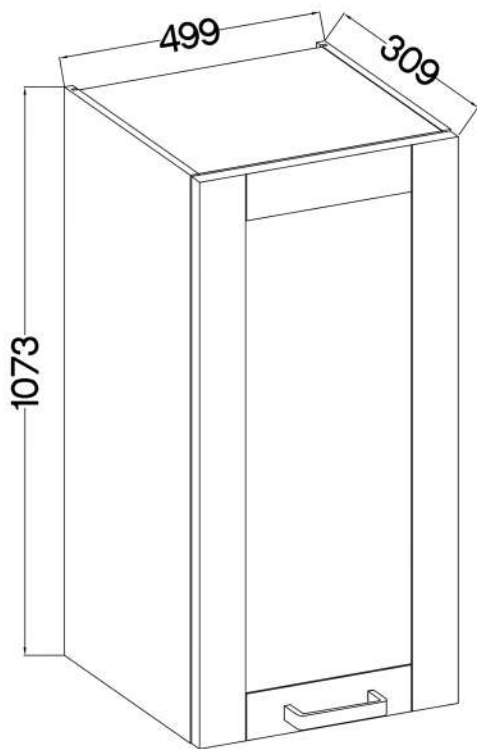
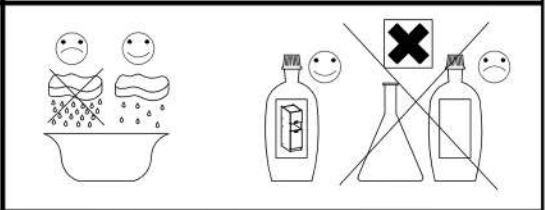

L=160mm	M4x27mm
S	U8
1	2

KUH.71407	1070x496x19
-----------	-------------

1

L



R

KUH.71407

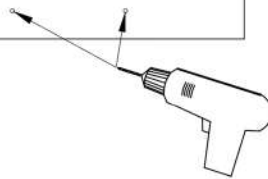
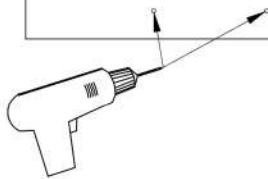
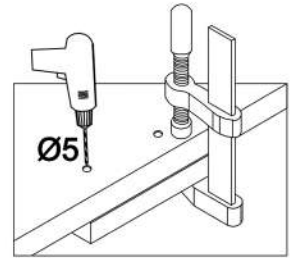
KUH.71407



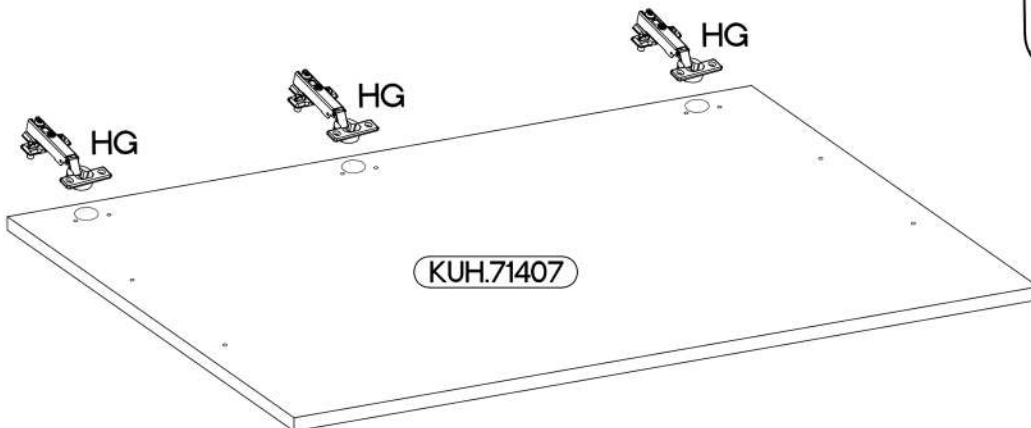
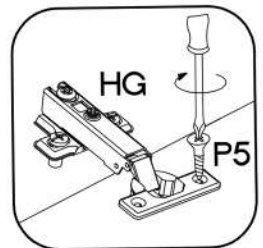

2

 HG 3	 P5 6
--	--



3

L=160mm	M4x27mm
	
S	U8
1	2

