

ARSANY 50 G-90 1F

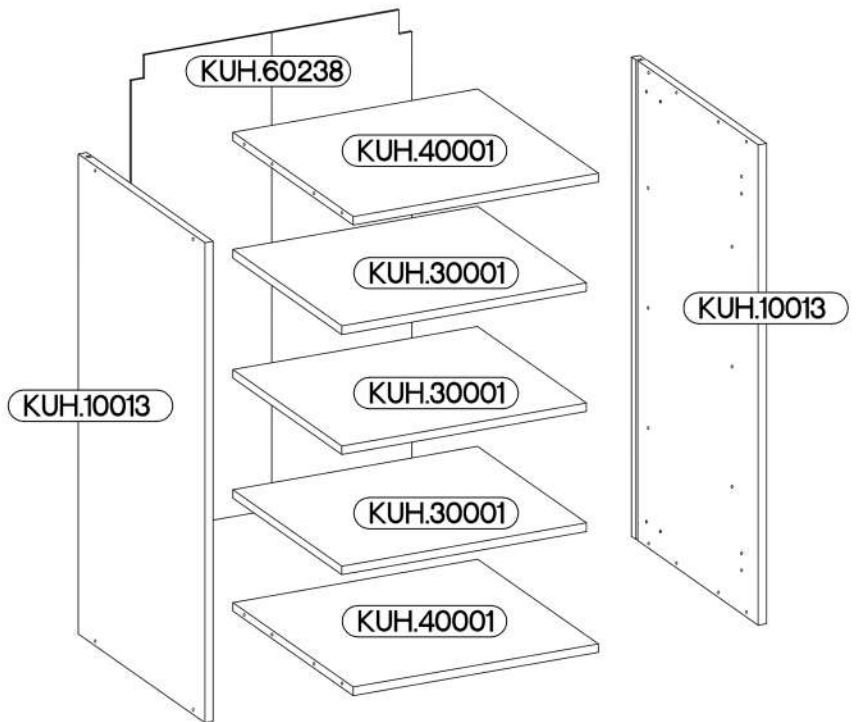

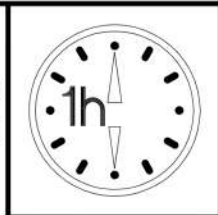
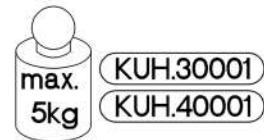
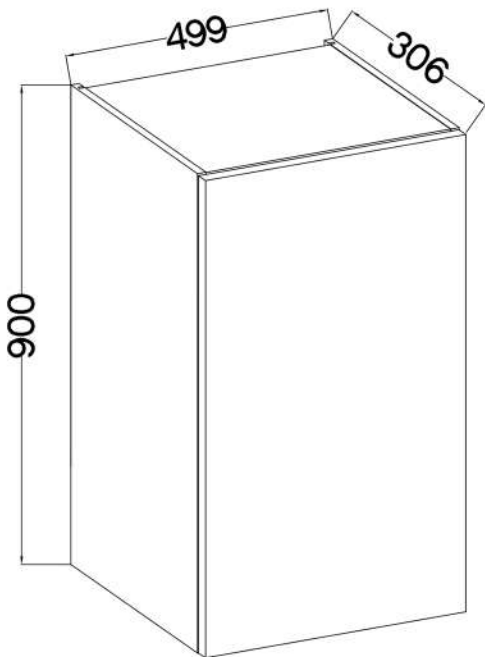
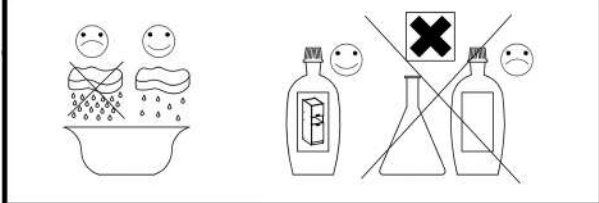
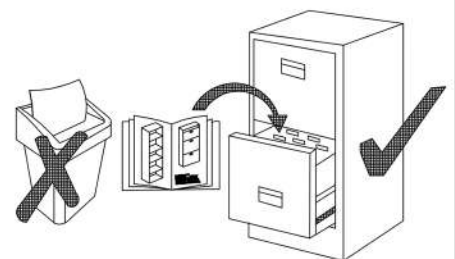

KUH.10013 x2	900x290x16
KUH.30001 x3	466x250x16
KUH.40001 x2	467x276x16
KUH.60238	896x485x2,5

 A 8	 B 8	 E1 8	 HG 2	 P5 4	 P7 8-10	 P8 4
 J 12	 K 2	 O 1	 P5 4	 P7 8-10	 P8 4	



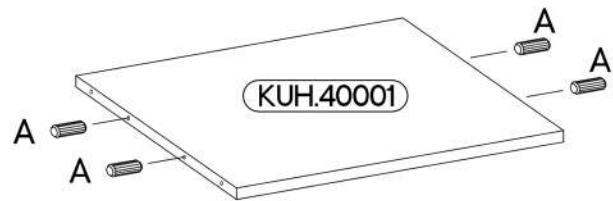
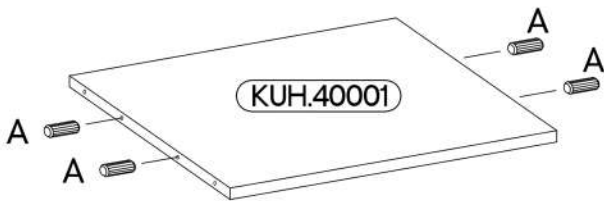
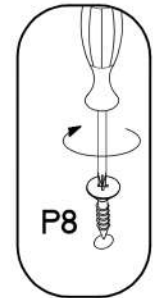
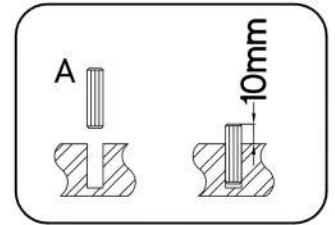
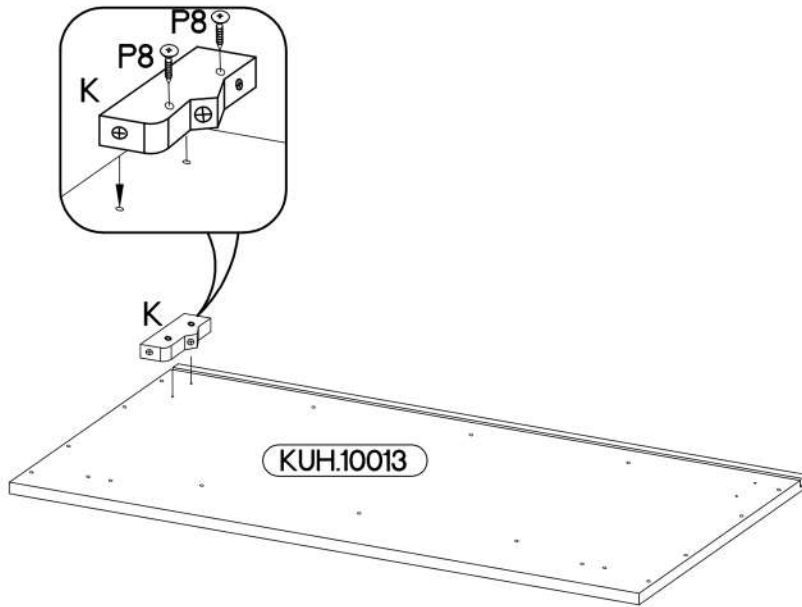
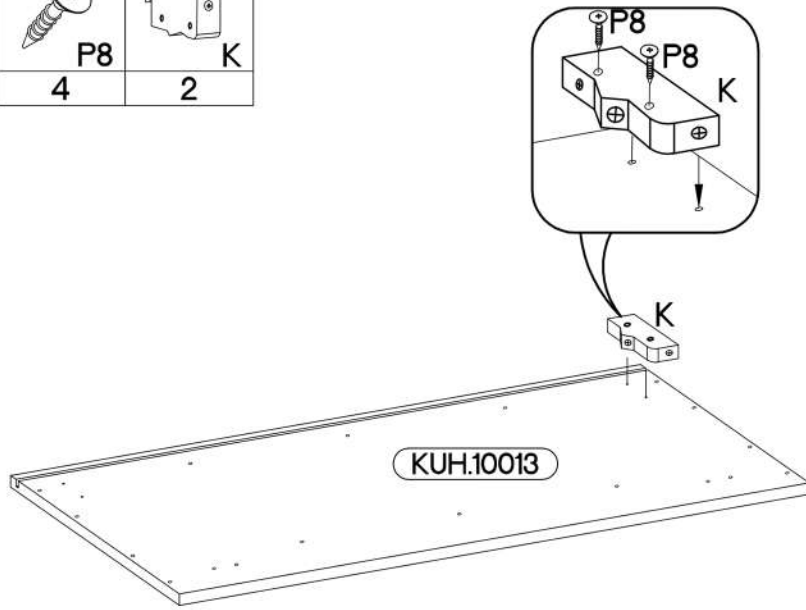

1

 ‡8x30mm A 8	 ‡4.0x30mm P8 4	 K 2
--	---	---





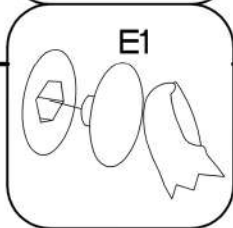
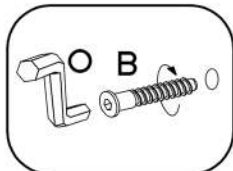
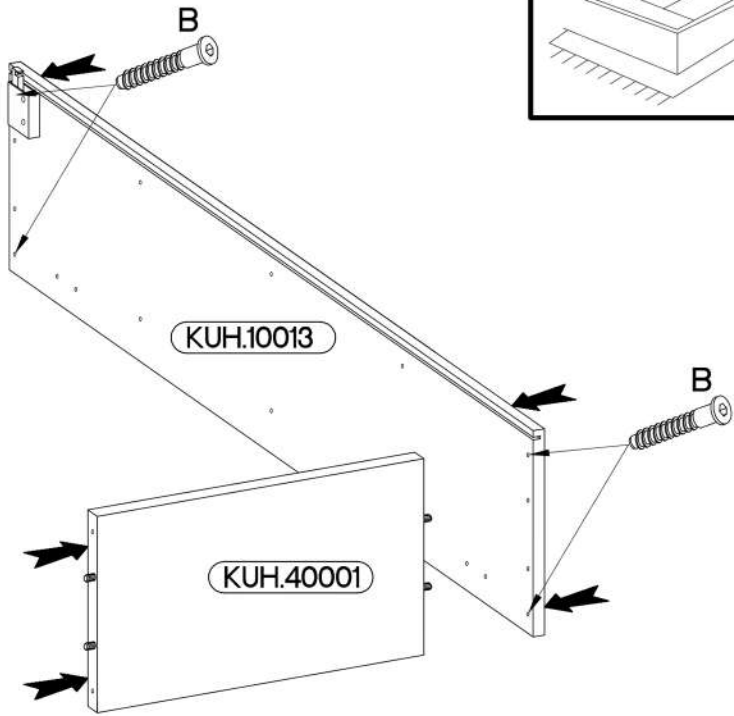
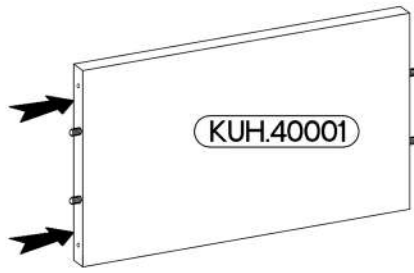

2

6,4 x 50mm		
		
B	O	E1
4	1	4

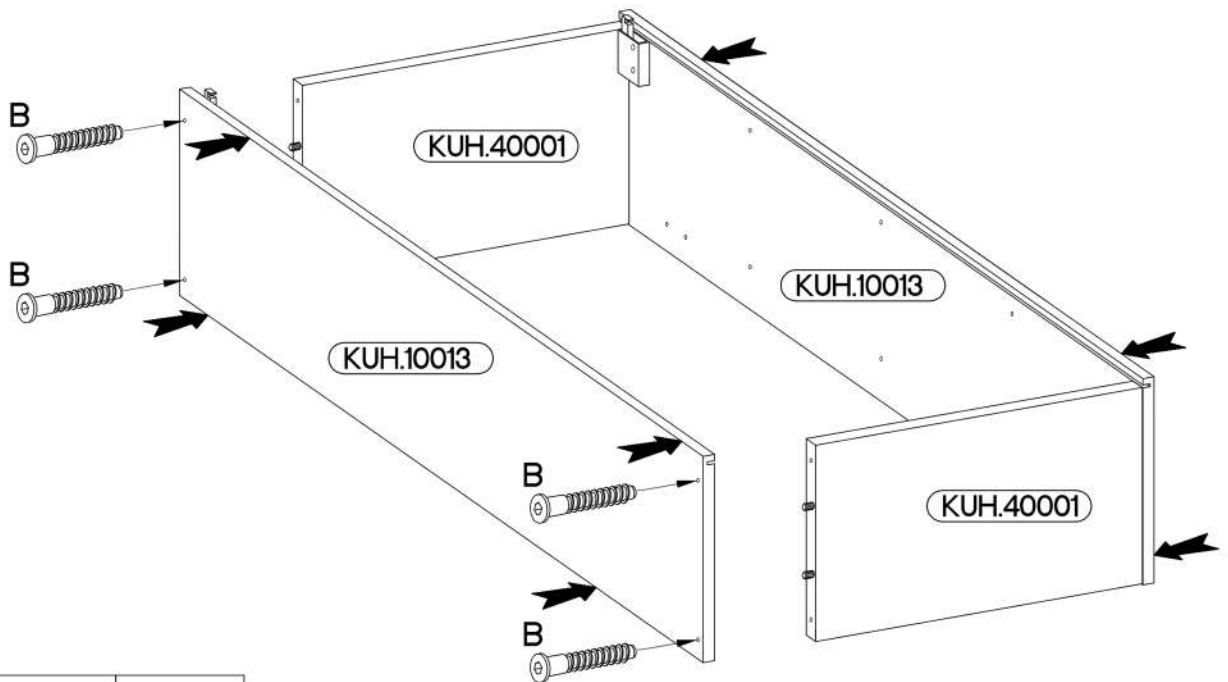

3



6,4 x 50mm		
		
B	O	E1
4	1	4

4

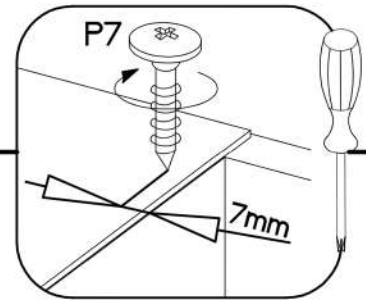
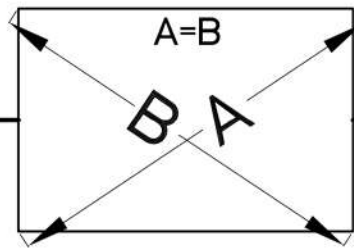
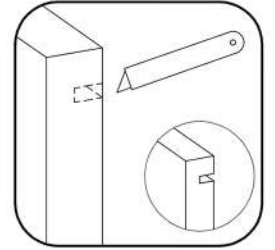
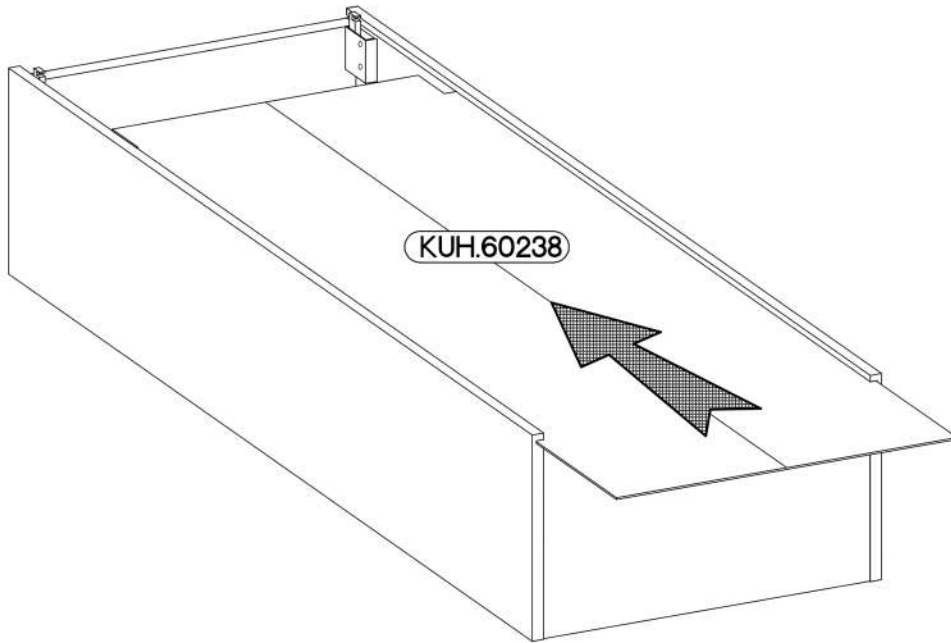

5

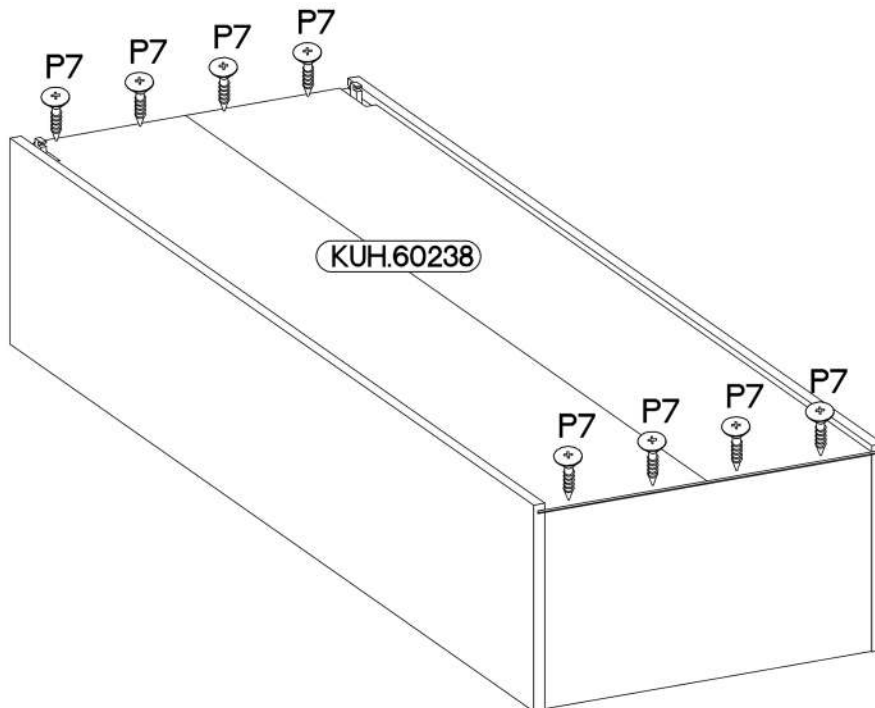

6

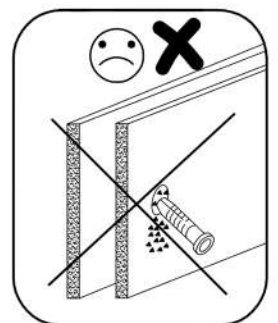
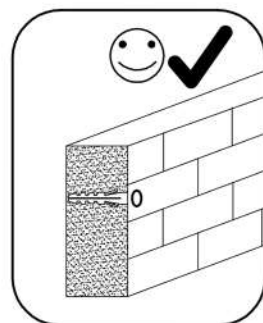
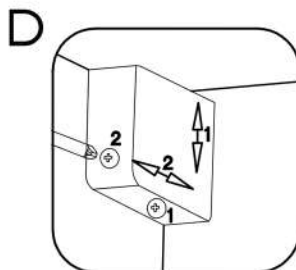
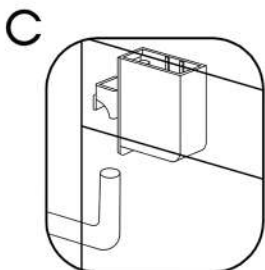
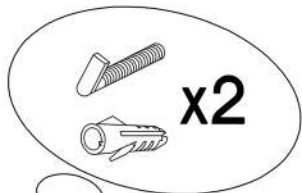
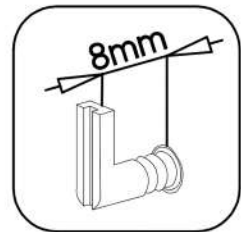
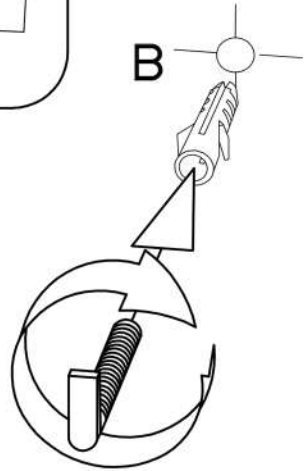
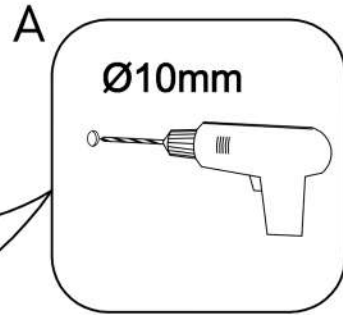
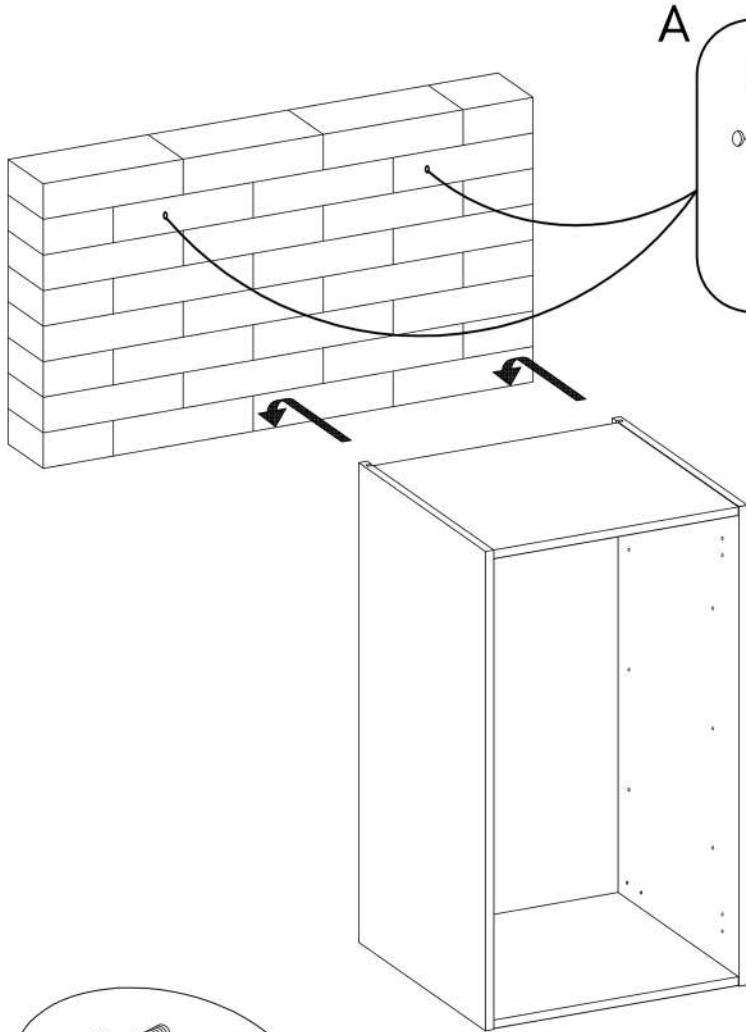
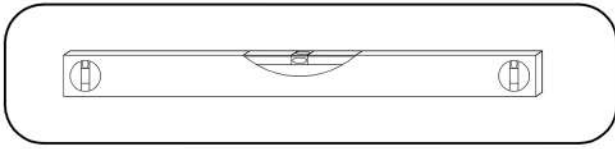

7

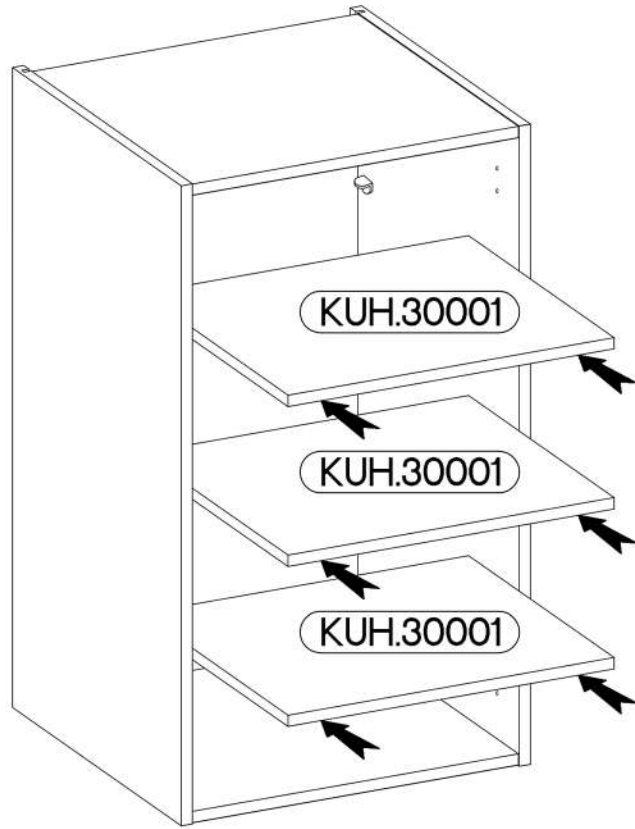
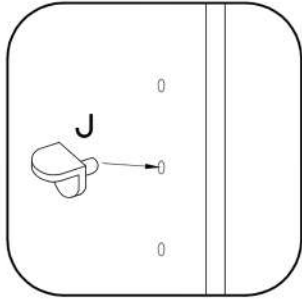
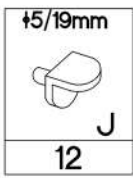

8

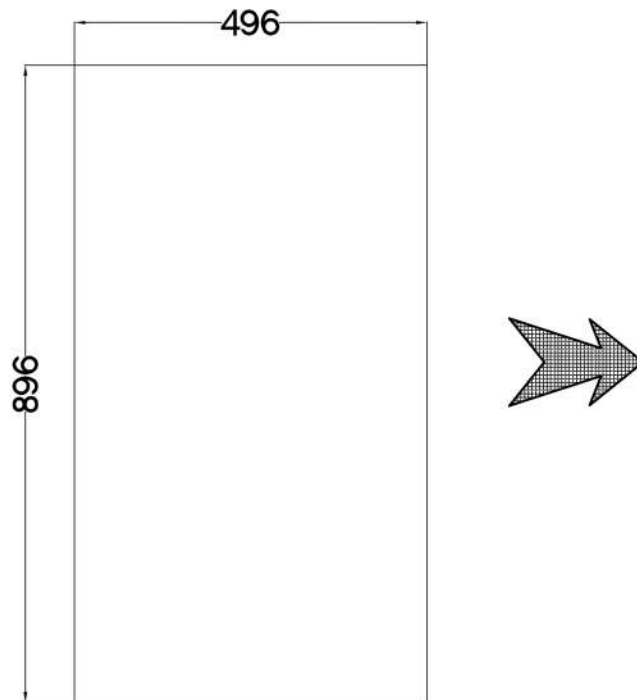

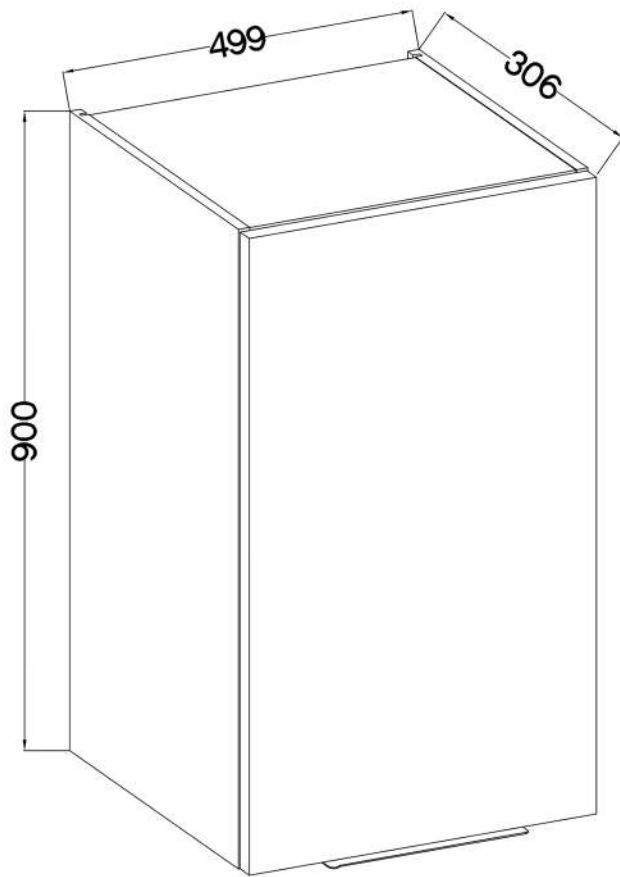

	<p>Ø5mm Ø10mm</p>		
	<p>0.5h</p>	<p>896x496</p>	



<p>L=256mm</p> <p>S</p>	<p>±7/2mm</p> <p>J5</p>
<p>1</p>	<p>2</p>

<p>KUH.71158</p>	<p>896x496x16</p>
------------------	-------------------

1

 [CD] HG 2	 P5 4	 J5 2
--	---	---

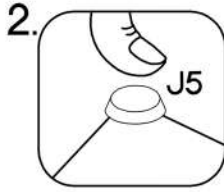
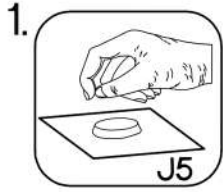
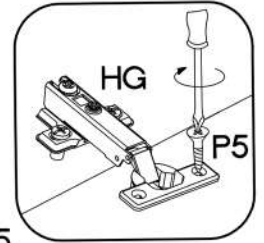
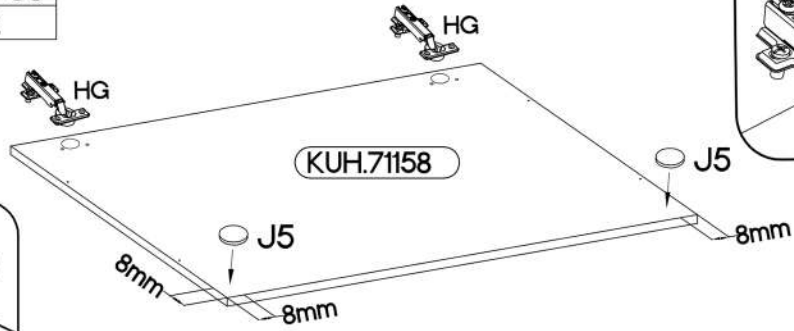

2

 L=256mm S 1
--

