

# ARSANY 50 G-72 1F

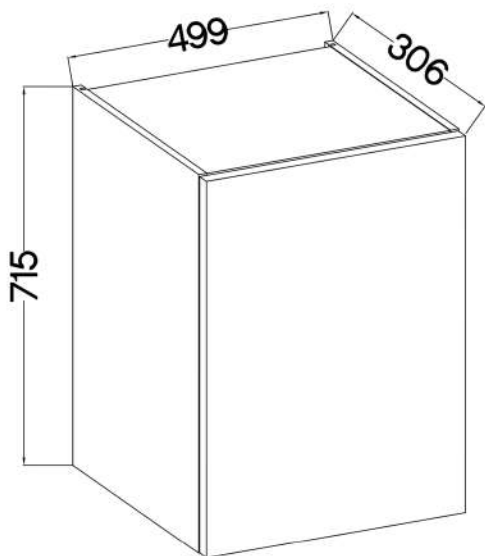

KUH.30001  
KUH.40001

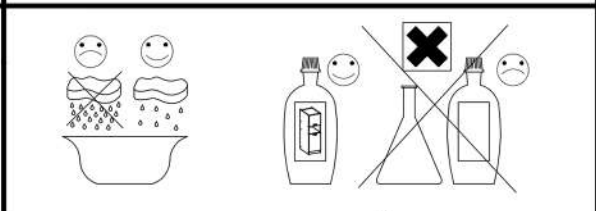

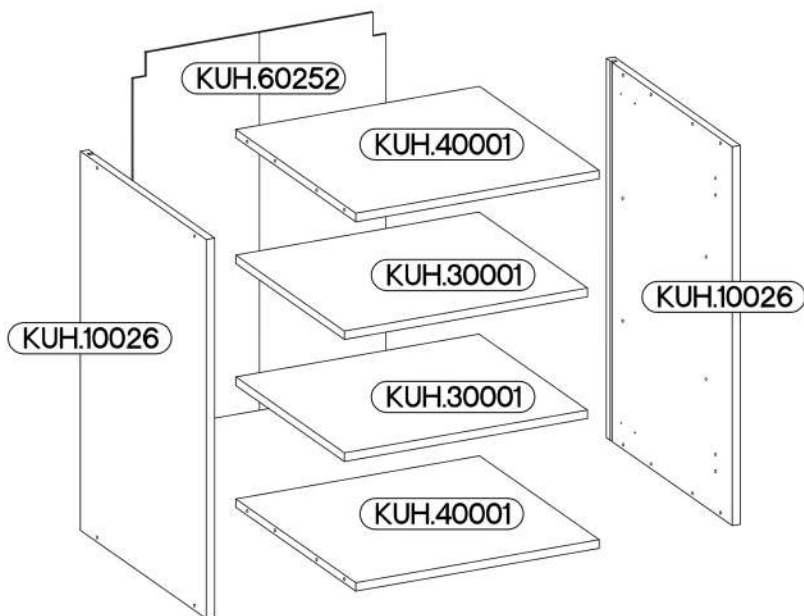

KUH.10026 x2	715x290x16
KUH.30001 x2	466x250x16
KUH.40001 x2	467x276x16
KUH.60252	713x485x2,5

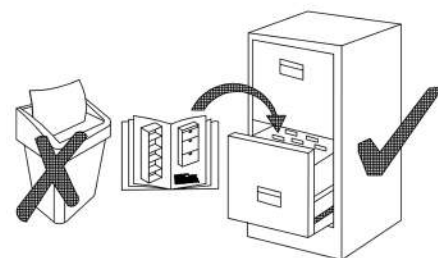
 A 8	 B 8	 E1 8	 HG 2	 J 8	 K 2	 O 1	 P5 4	 P7 8-10	 P8 4
------------	------------	-------------	-------------	------------	------------	------------	-------------	----------------	-------------

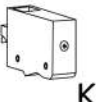

1

$\pm 8 \times 30 \text{mm}$  A 8	$\pm 4.0 \times 30 \text{mm}$  P8 4	 K 2
--	---	---

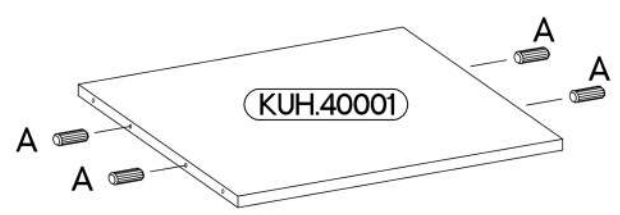
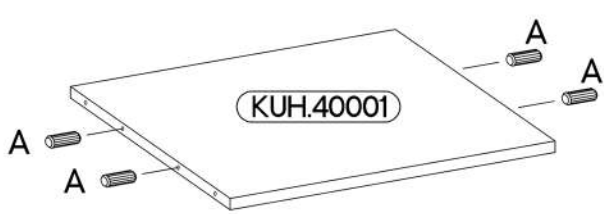
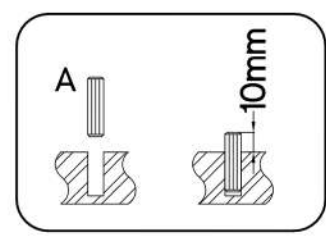
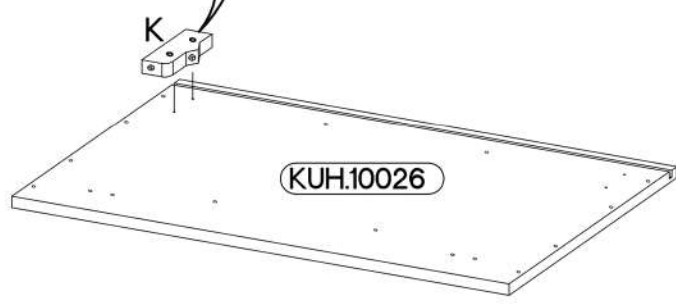
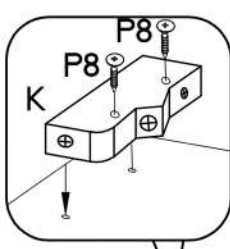
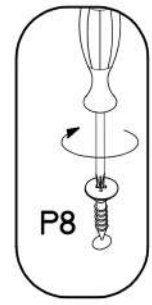
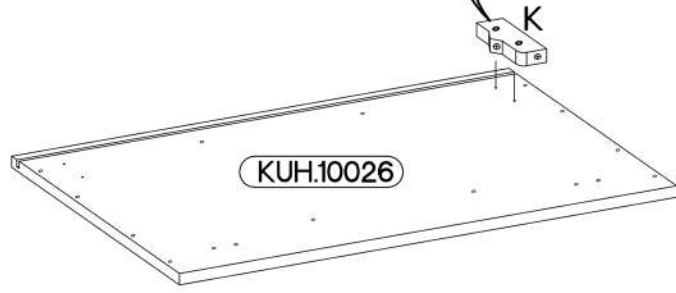
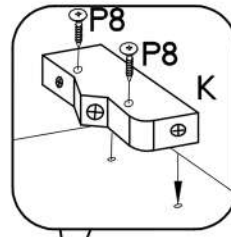

2

6,4 x 50mm

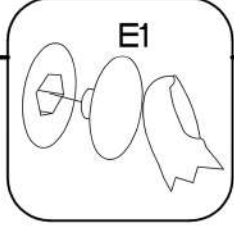
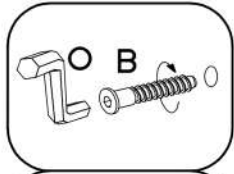
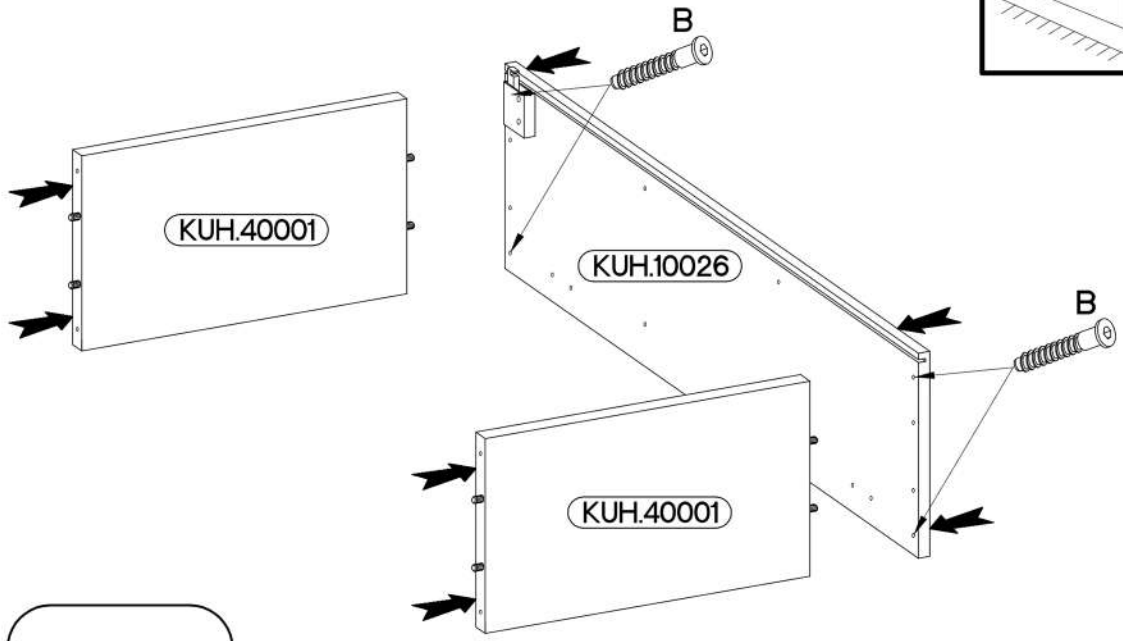
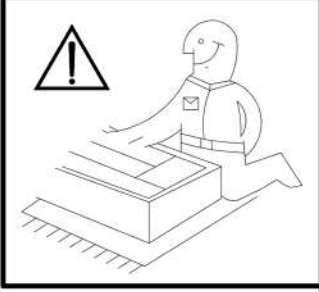
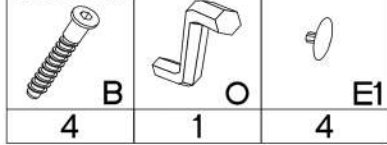

3

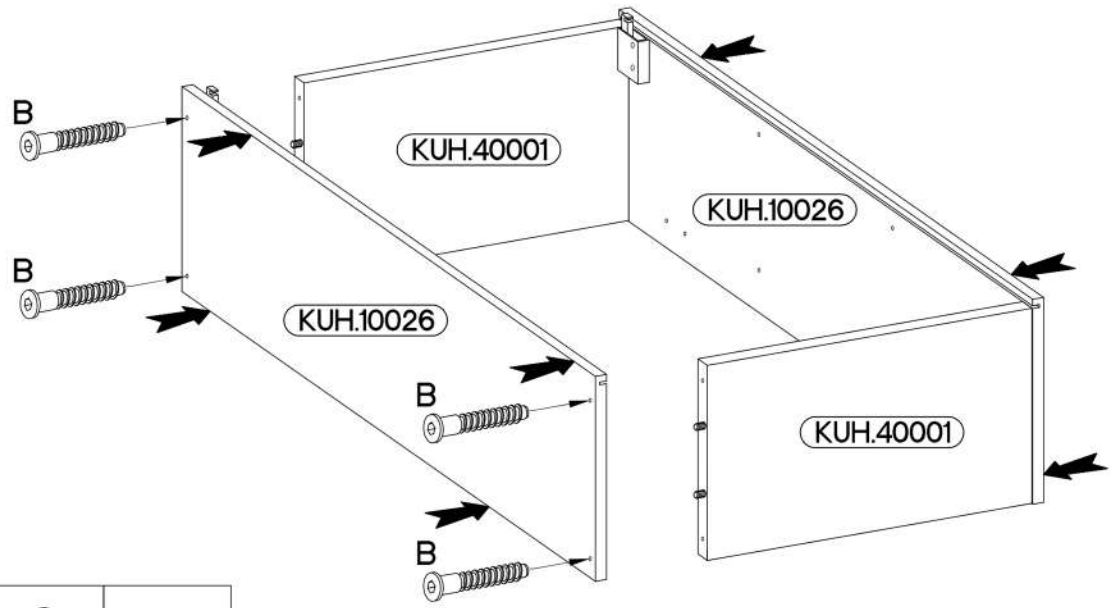

6,4 x 50mm

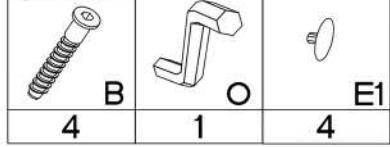

4

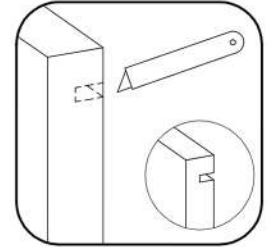
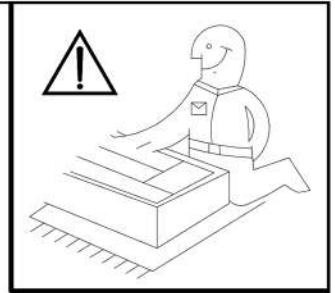
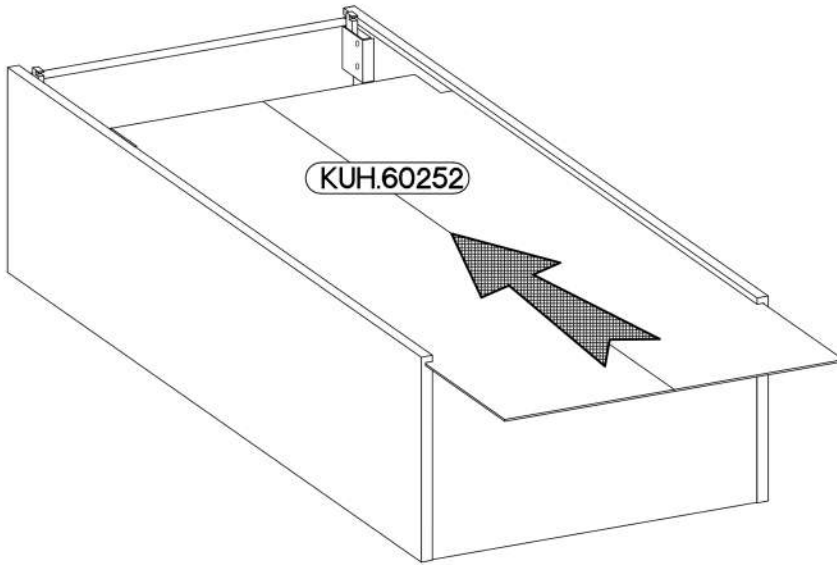

5

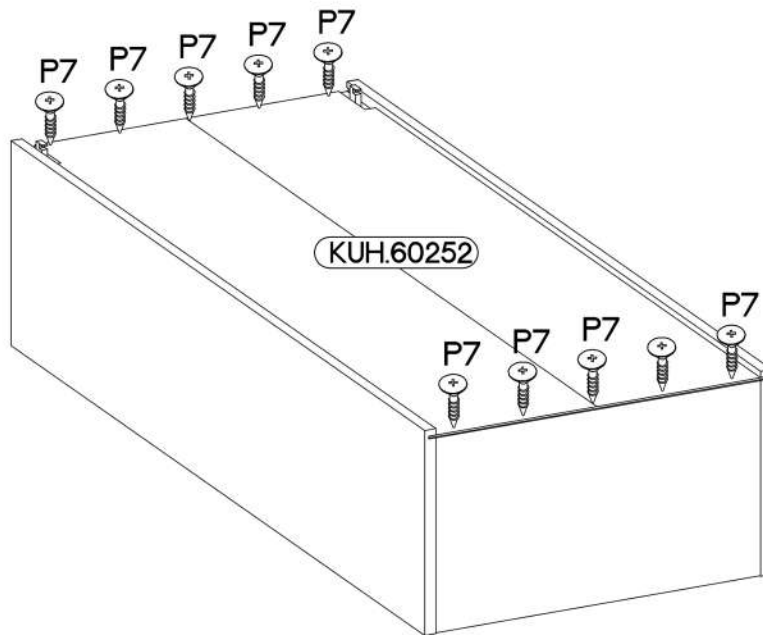
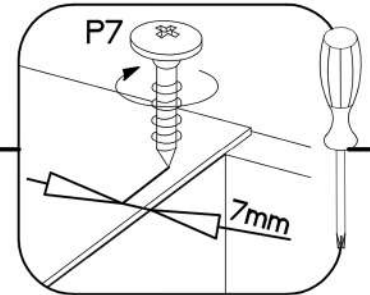
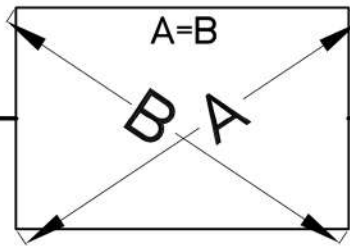

6

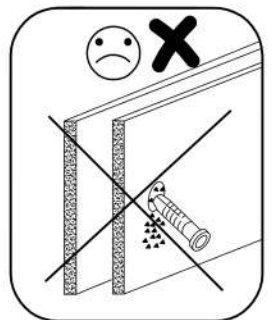
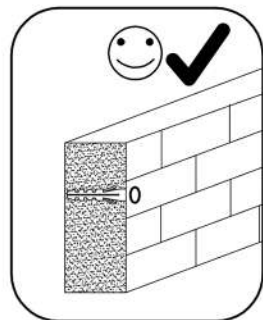
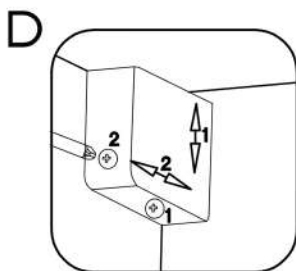
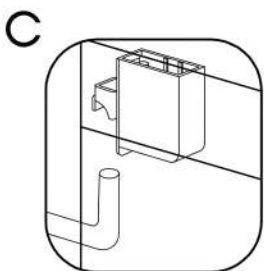
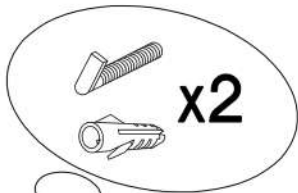
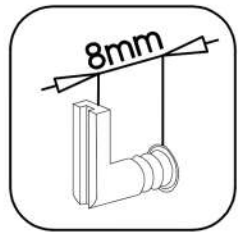
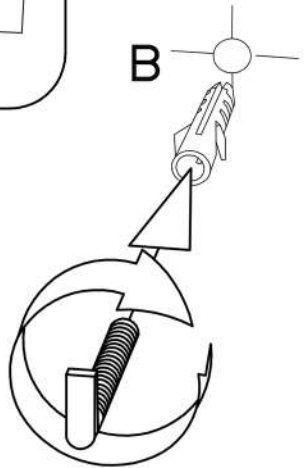
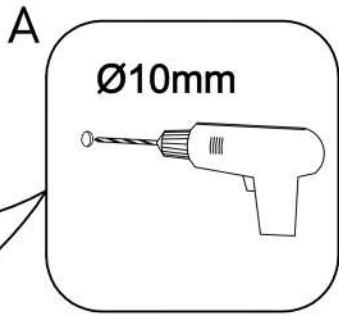
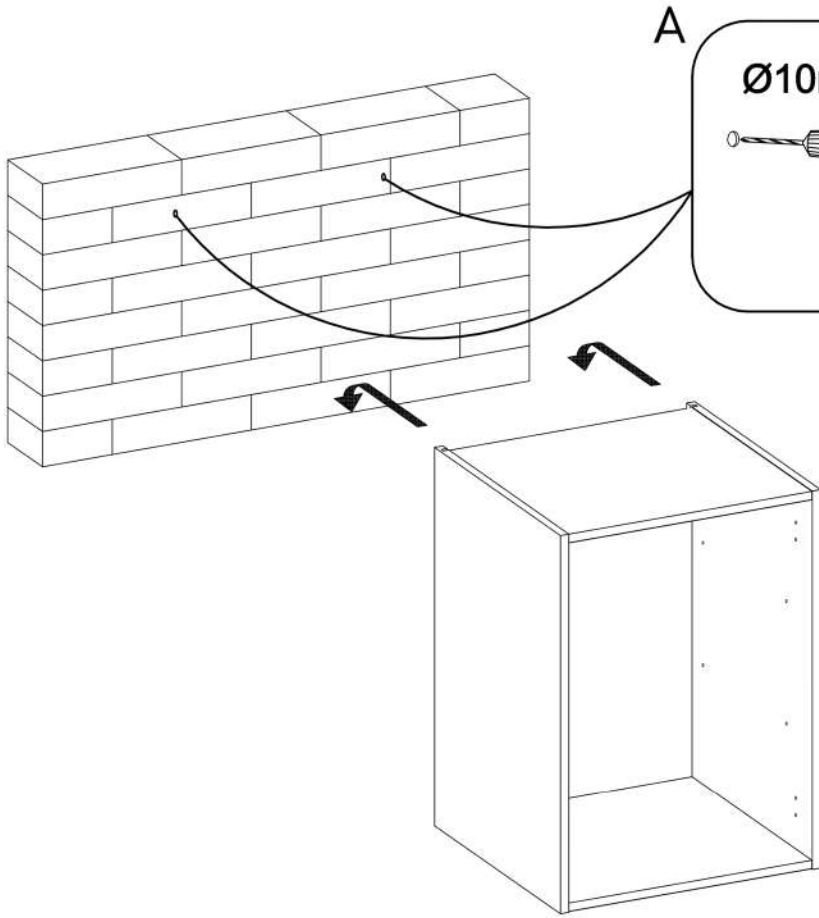
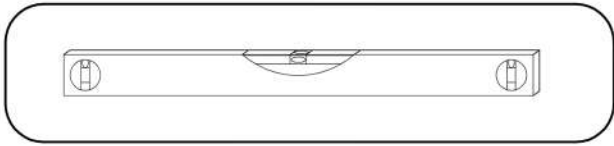

7

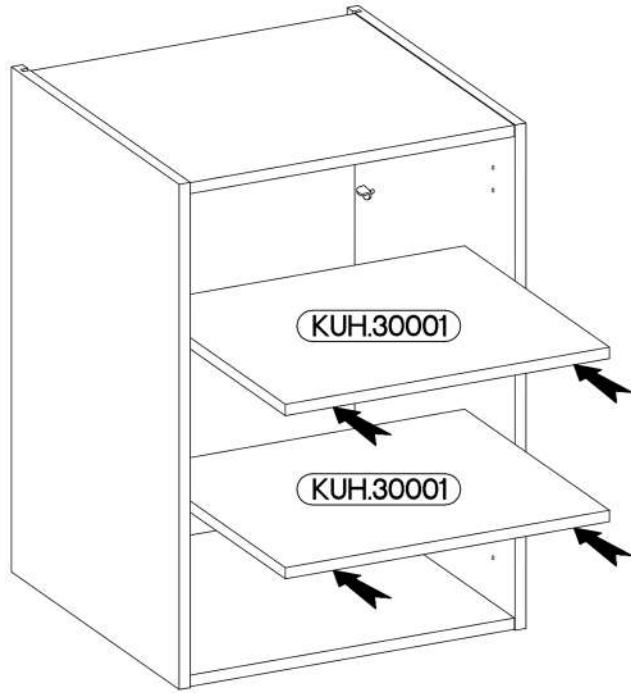
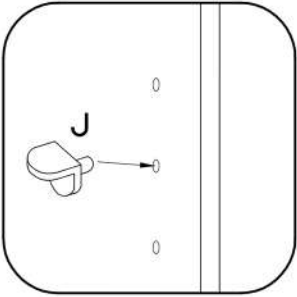
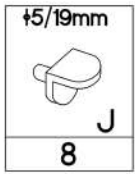

8

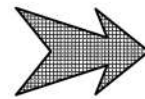
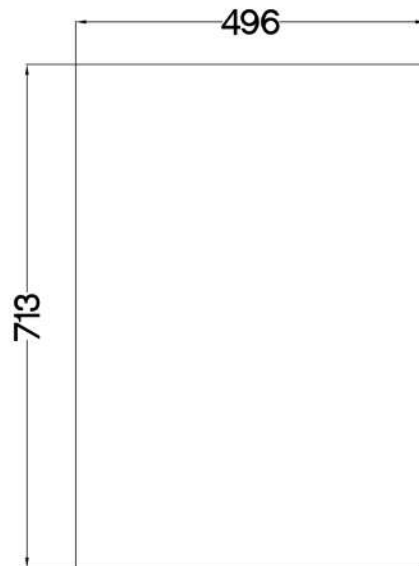

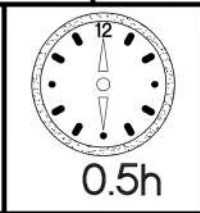
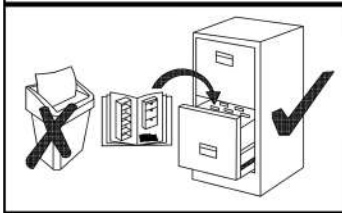
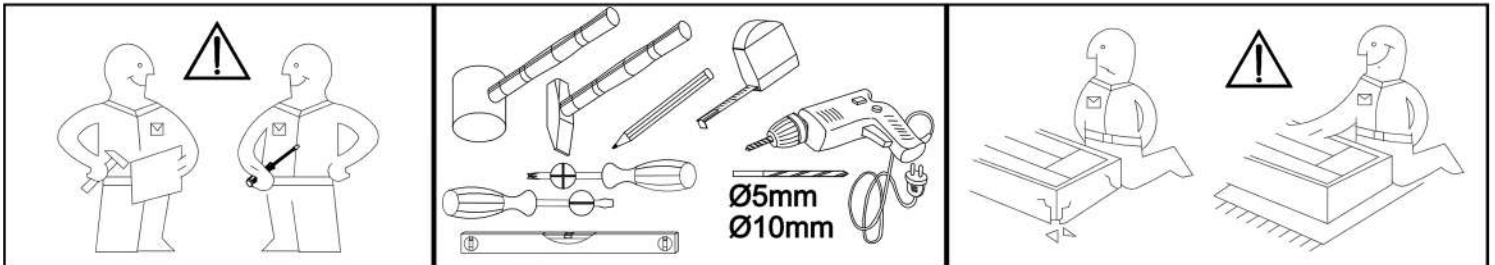

**713x496**

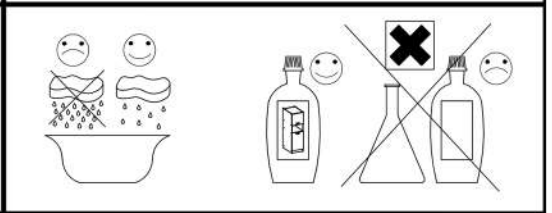

**50 ZL 1F BB**

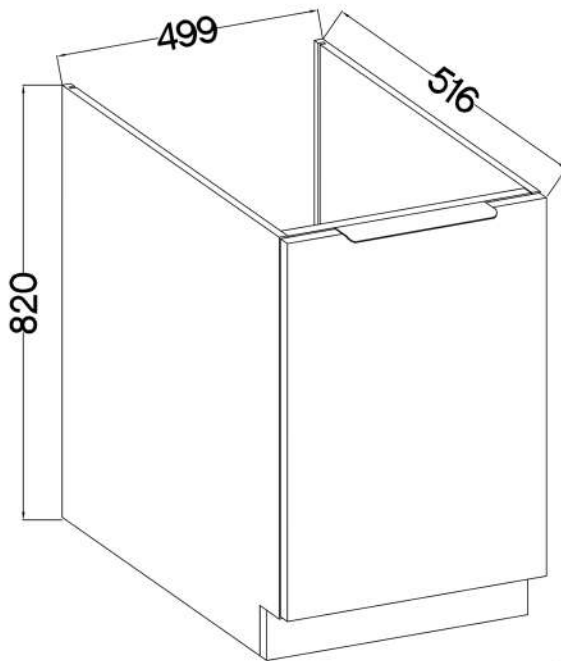

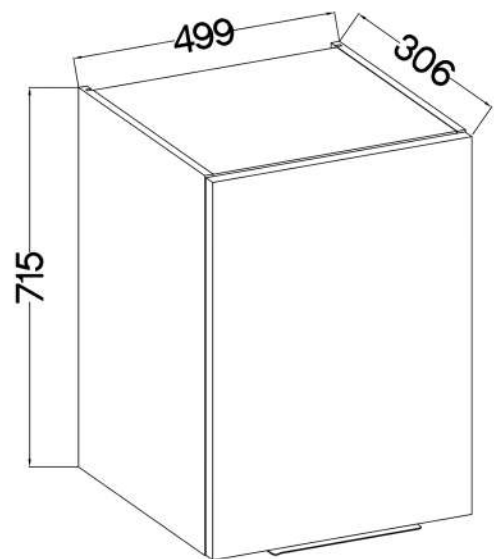

**50 G-72 1F**



L=256mm	+7/2mm
S	J5
1	2

KUH.71150	713x496x16
-----------	------------

# 1 50 ZL 1F BB

$\pm 35/0\text{mm}$  [CD] HG 2	$\pm 3.5 \times 13\text{mm}$  P5 4	$\pm 7/2\text{mm}$  J5 2
--	--	--

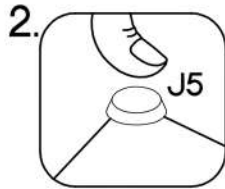
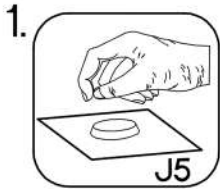
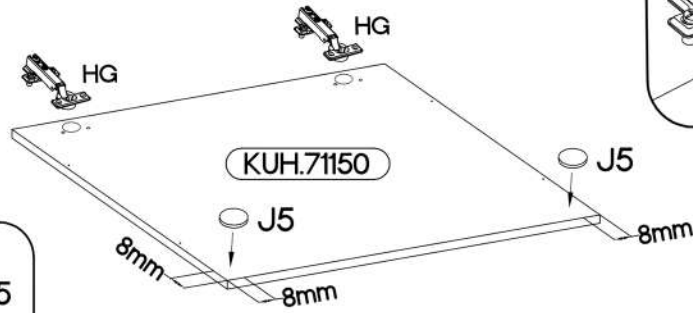
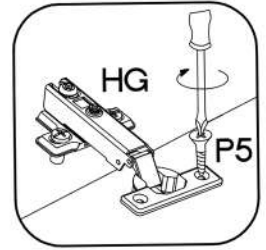

# 2

$L=256\text{mm}$  S 1
---

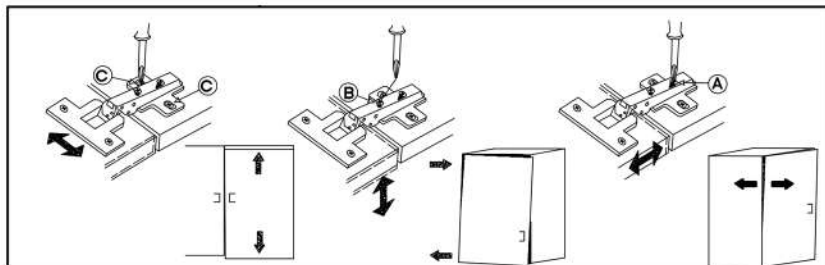
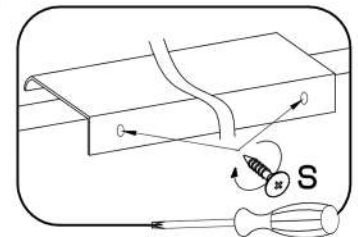
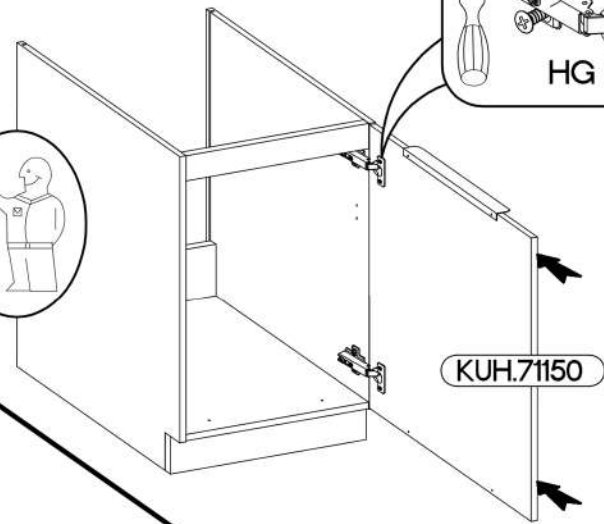
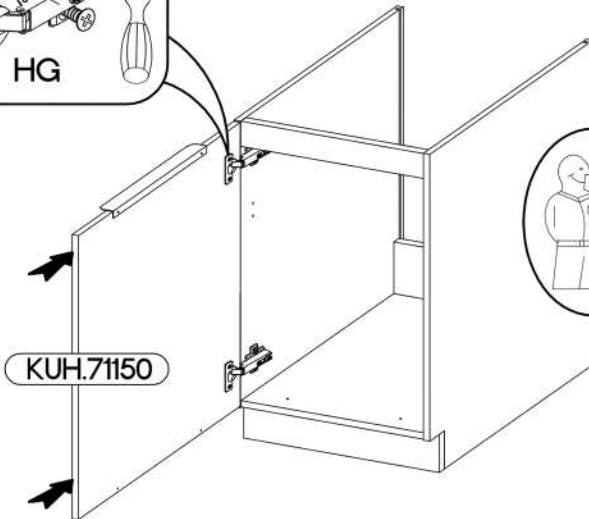
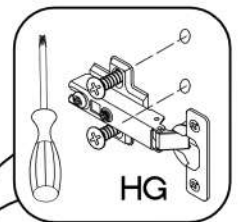
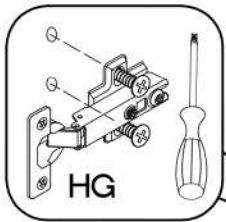

3

50 G-72 1F

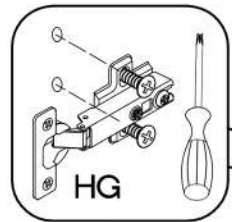
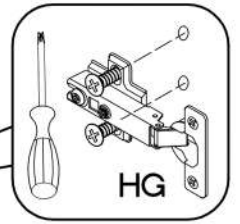
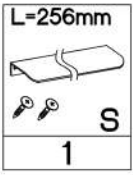

KUH.71150



KUH.71150

