

ARSANY 80 G-108 2F

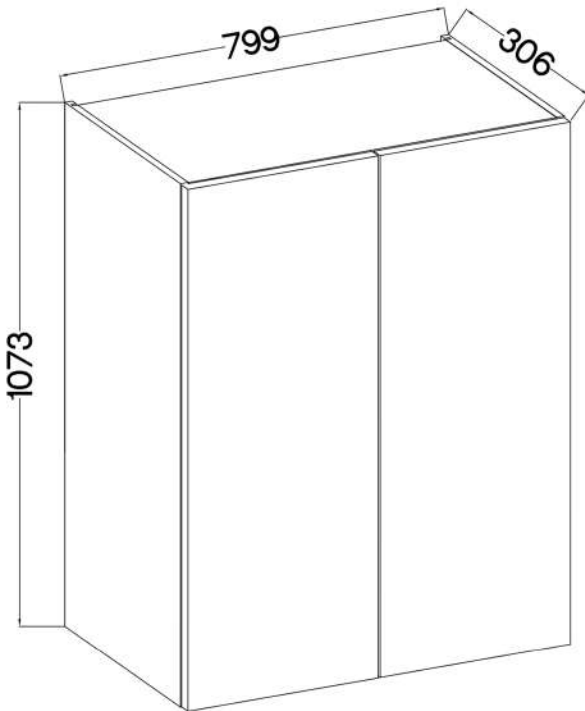

max.
5kg

KUH.30011
KUH.40022

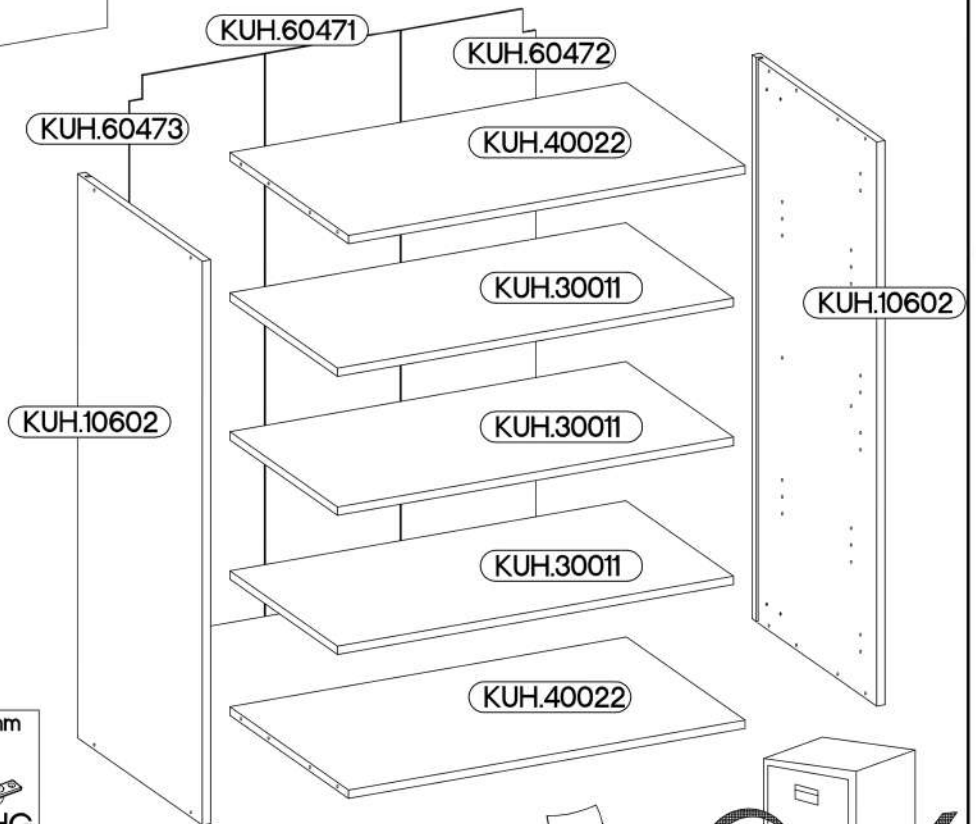

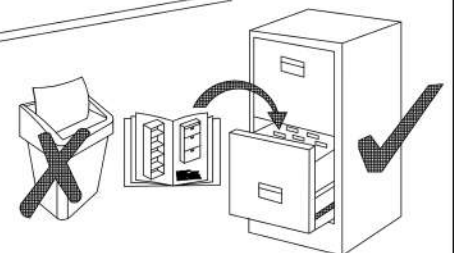

KUH.10602 x2	1073x290x16
KUH.30011 x3	766x250x16
KUH.40022 x2	767x276x16
KUH.60471	1070x260x2,5
KUH.60472	1070x260x2,5
KUH.60473	1070x260x2,5

 A 8	 B 8	 E1 8	 HG 6	 P5 12	 P7 15-20	 P8 4
 J3 12	 K 2	 L1 2	 O 1	 L1-1038mm 2	 P5 12	 P7 15-20



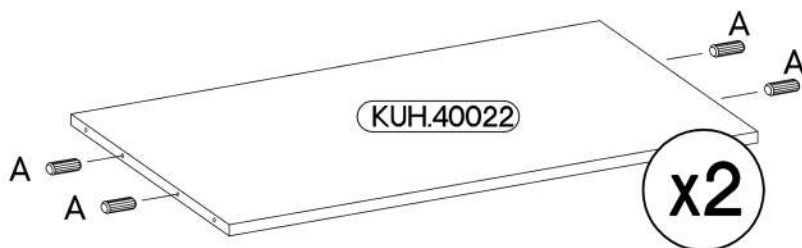
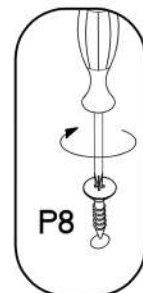
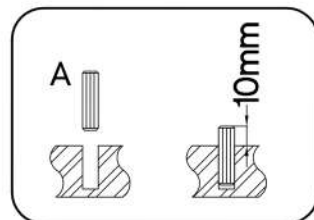
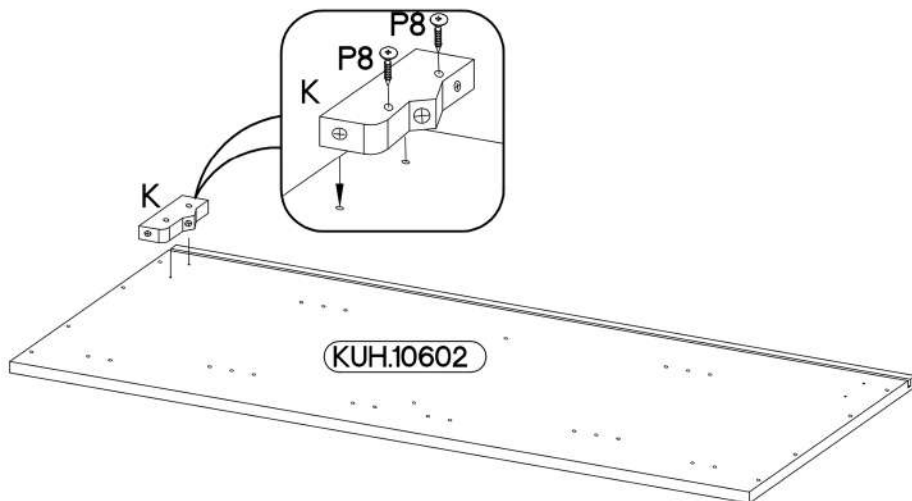
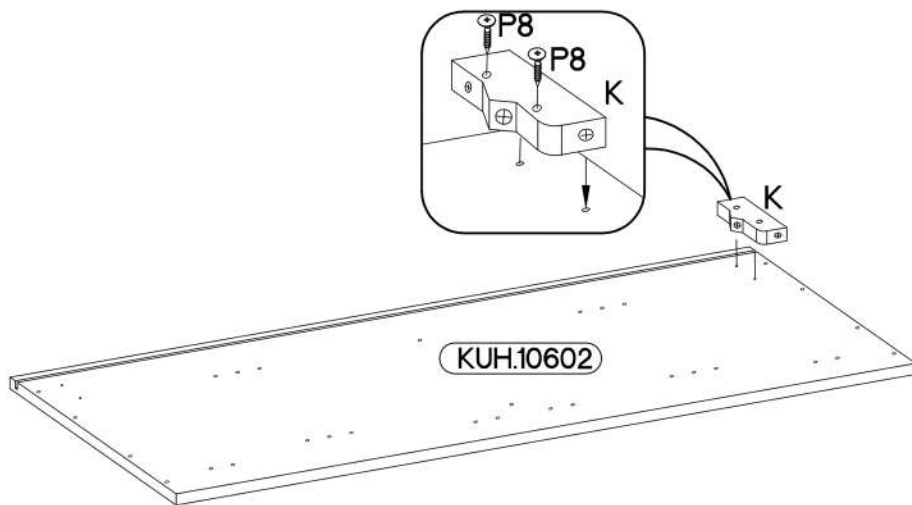
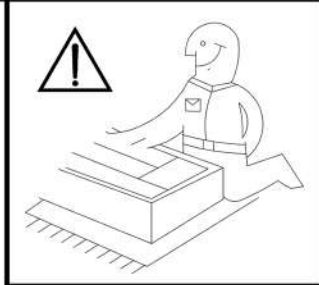

1

 8x30mm A	 4.0x30mm P8	 K
8	4	2





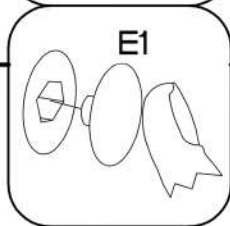
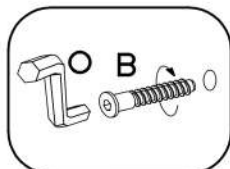
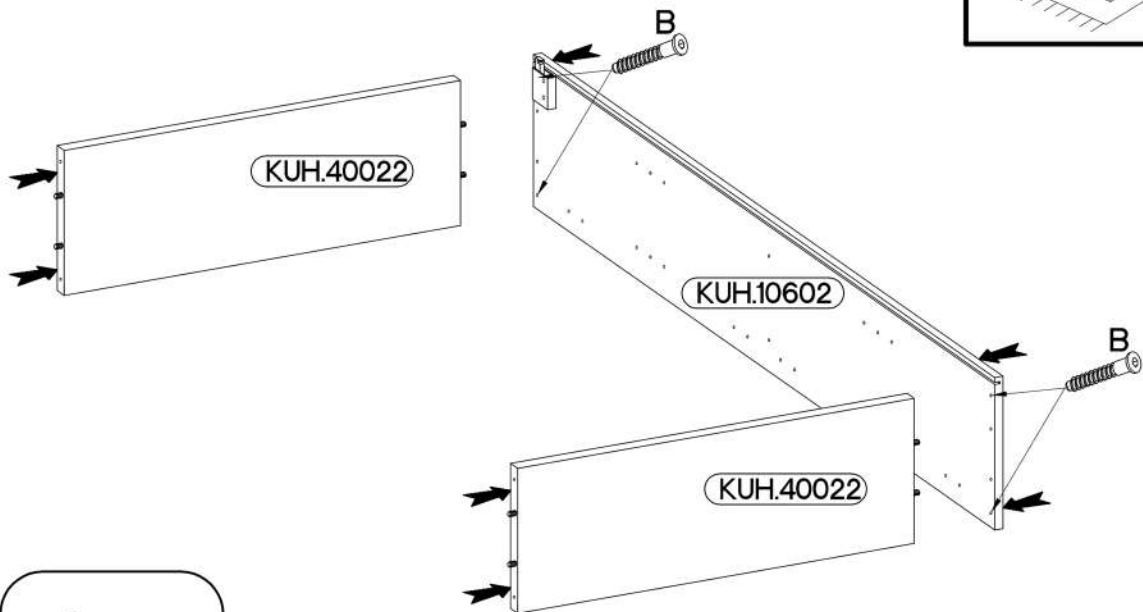
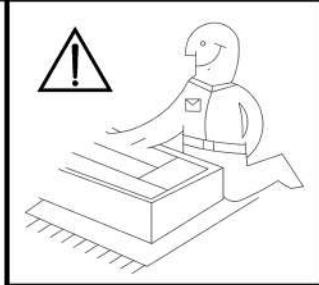

2

6,4 x 50mm		
		
B	O	E1
4	1	4

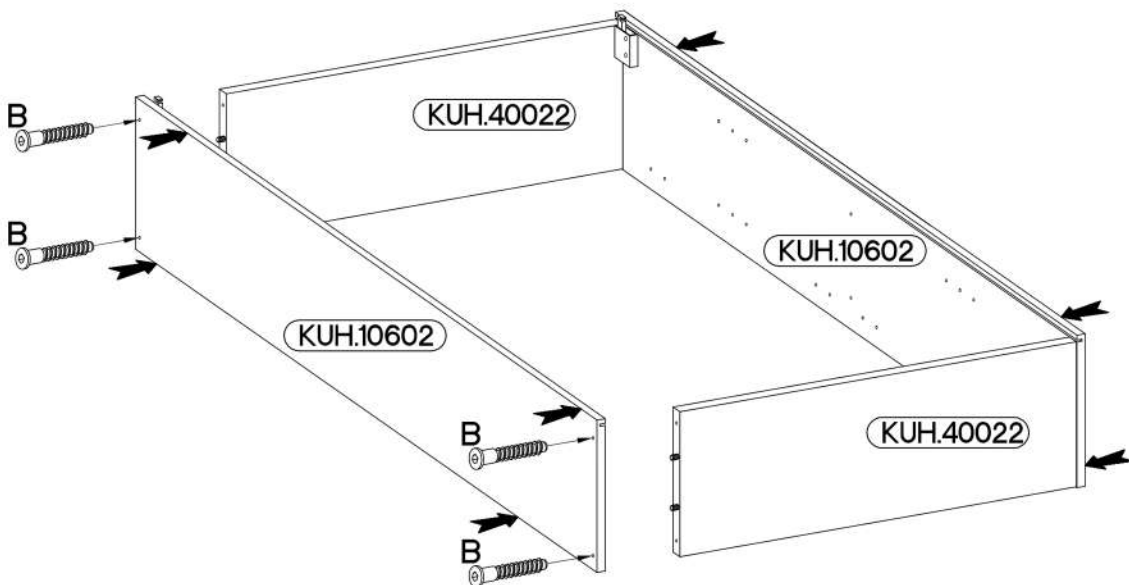

3



6,4 x 50mm		
		
B	O	E1
4	1	4

4

L1=1038mm

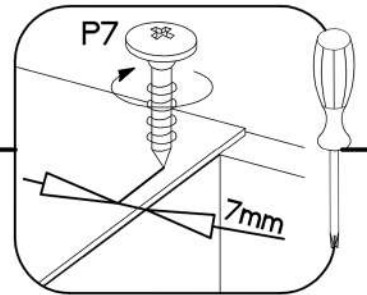
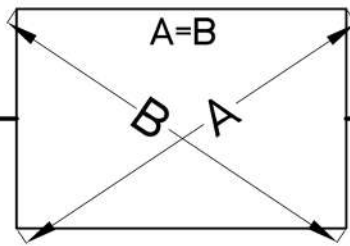
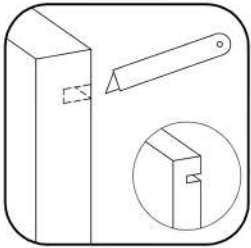
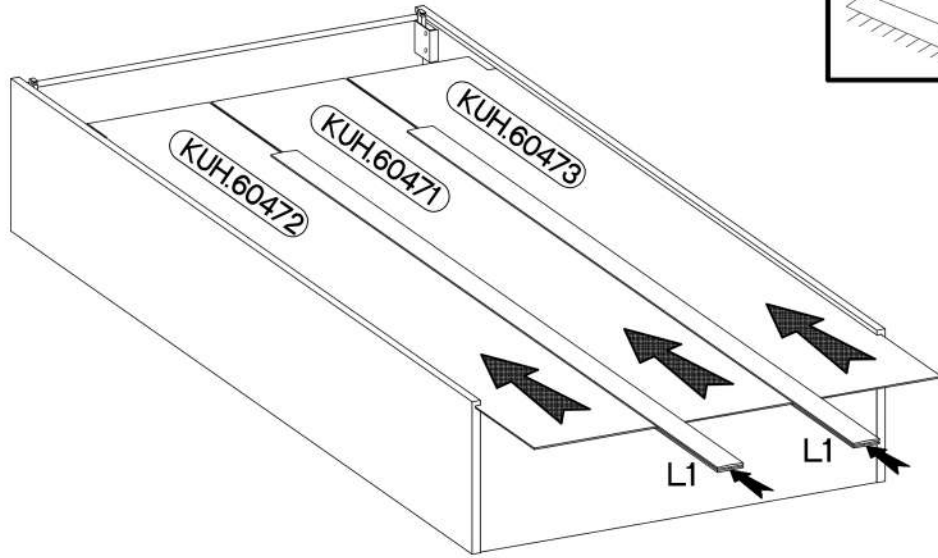
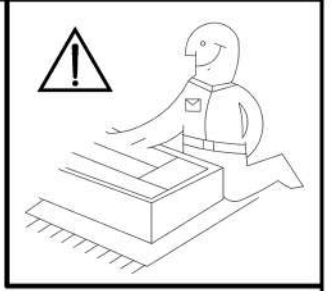
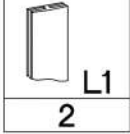

5

±3.0x20mm

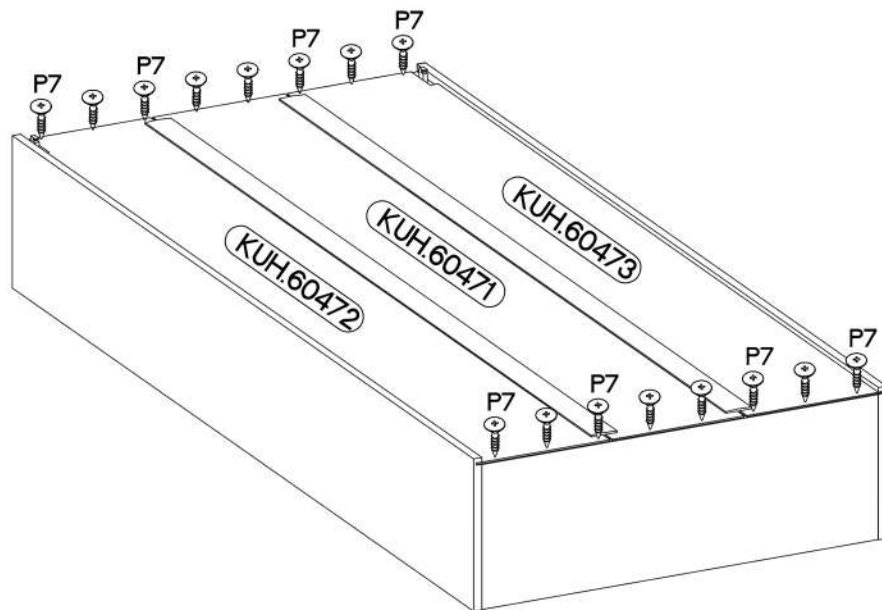
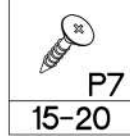

6

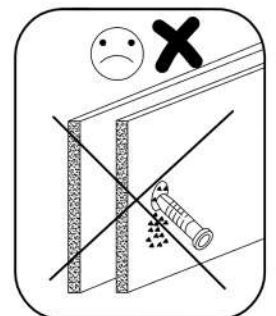
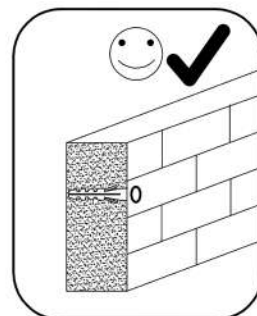
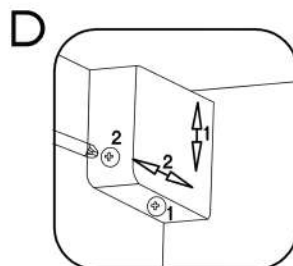
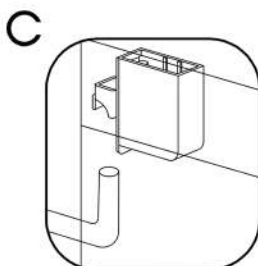
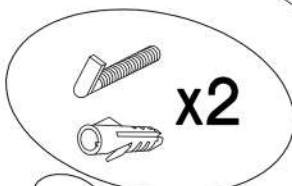
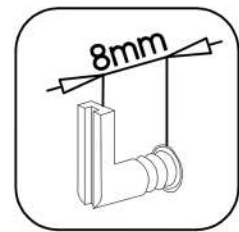
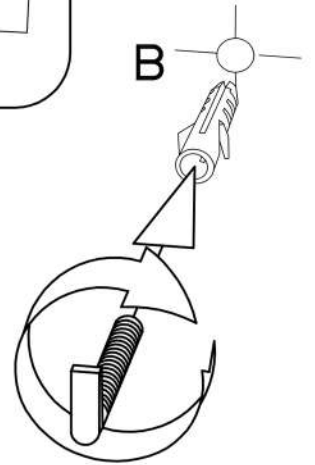
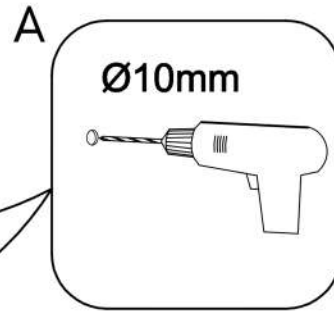
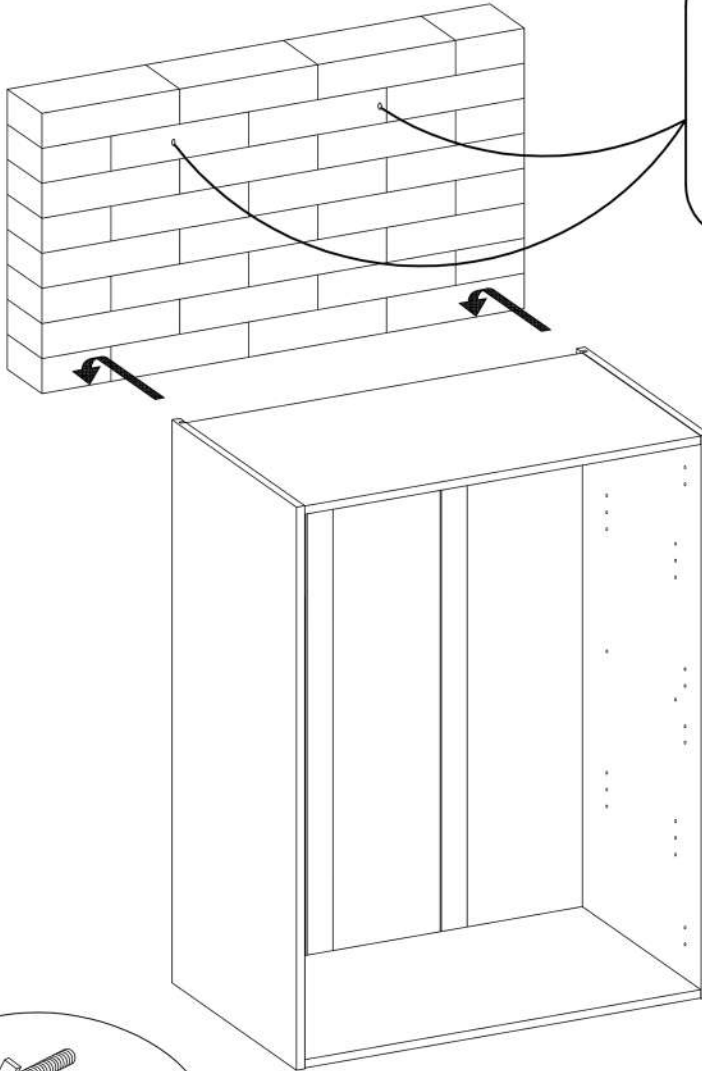
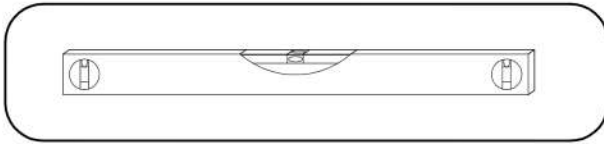

7

±5/16mm



J3

12

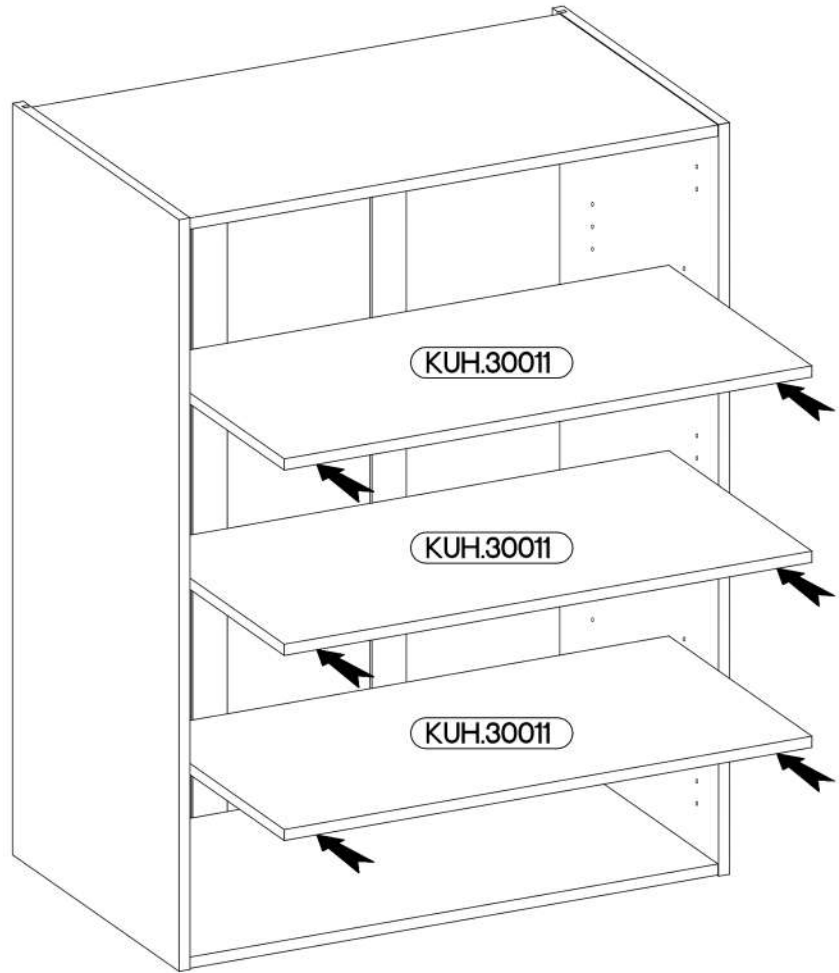
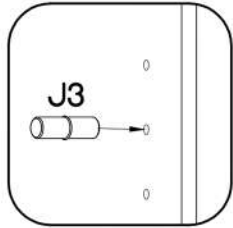

8

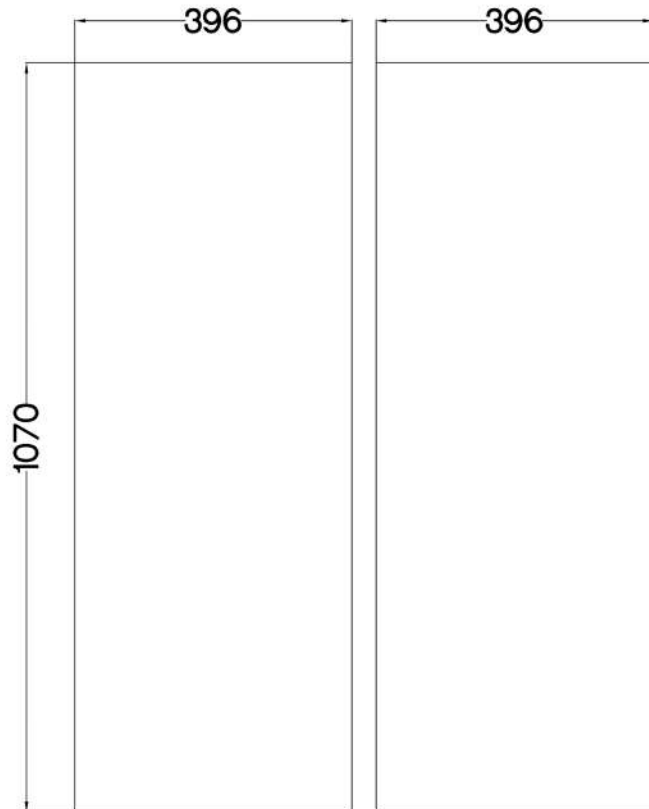

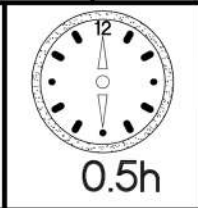
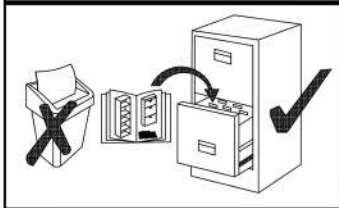
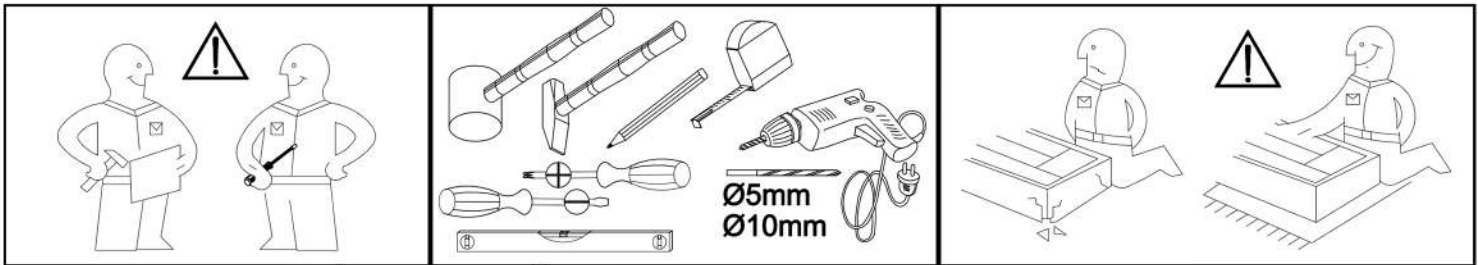

1070x396

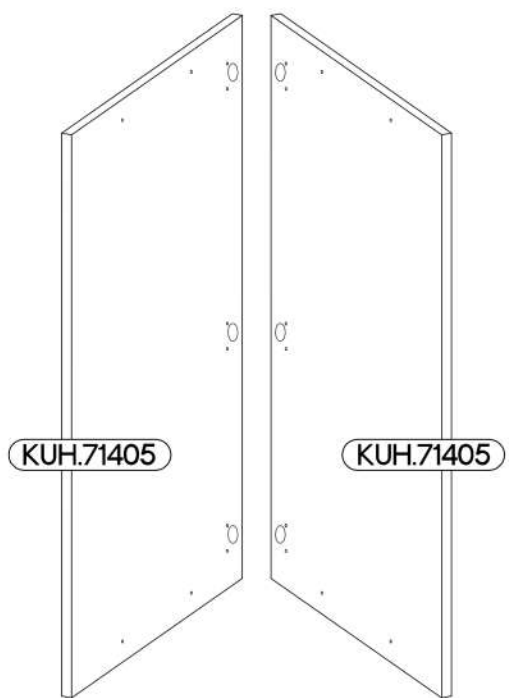
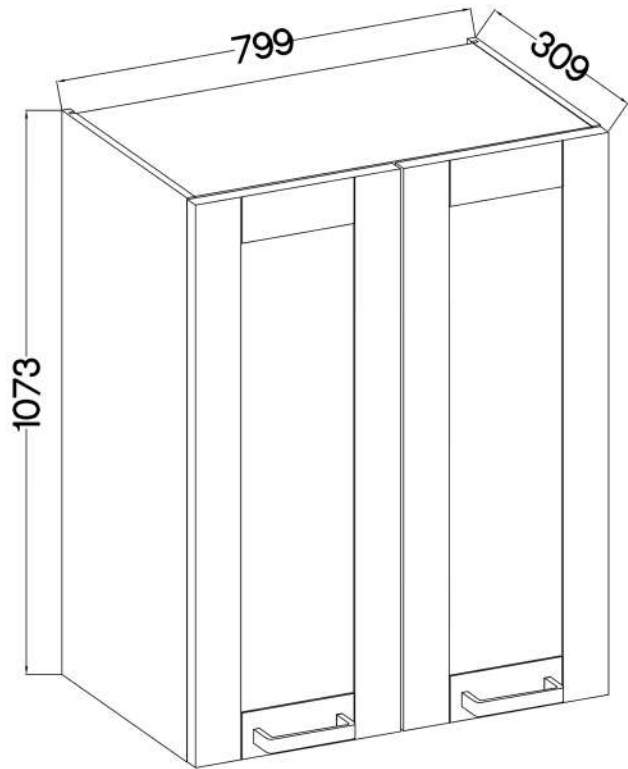



L=160mm	M4x27mm
S	U8
2	4

KUH.71405 x2 1070x396x19

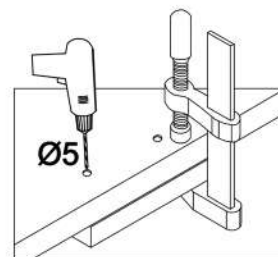
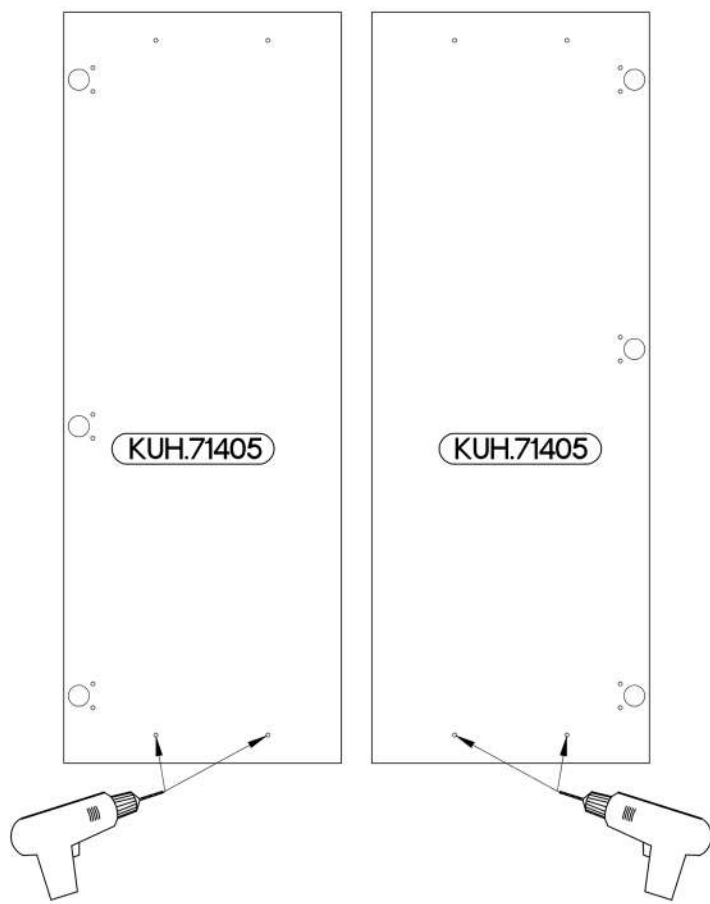
1



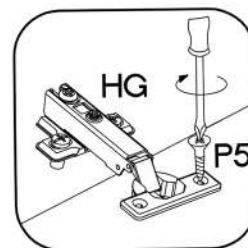
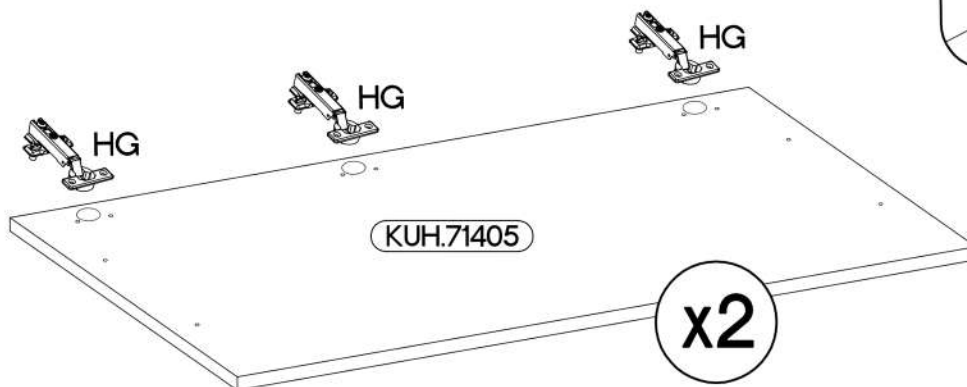

2

 HG	 P5
6	12



3

L=160mm	M4x27mm
	
S	U8
1	2

