

ANTONY 4D3S

1600x1961x550 mm

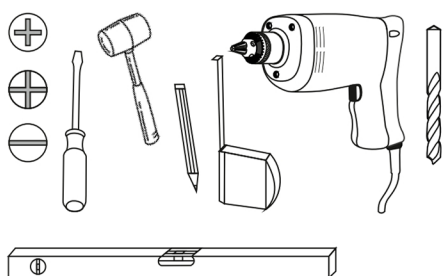

2.

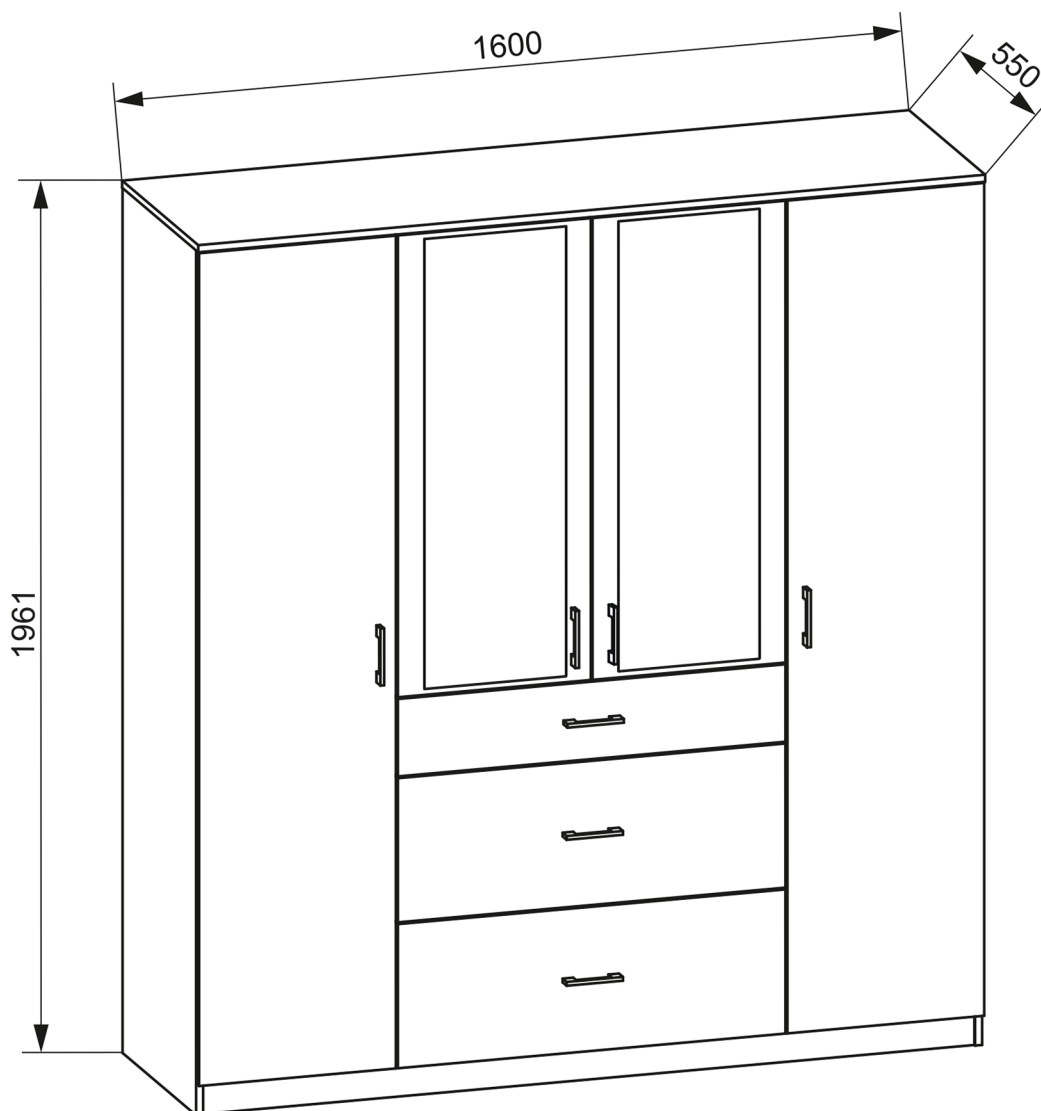
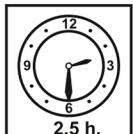

2,5 h.



pevne dotiahnuť / utáhnout
zategnuti / szorosan meghúzni
strângere / trdno pritegniti



zatlačiť / stlačit / utisnuti / benyomni
introducere prin apăsare / vtisniti



odmerať / změřit / izmjeriti
kimérni / măsurare / izmeriti



stlačit / stisknout / pritisnuti
(meg)nyomni / apăsare / vtisniti



zatlčit / zatlouct / zabiti čekicem
kalapácsolni / introducere prin bătaie
bevern





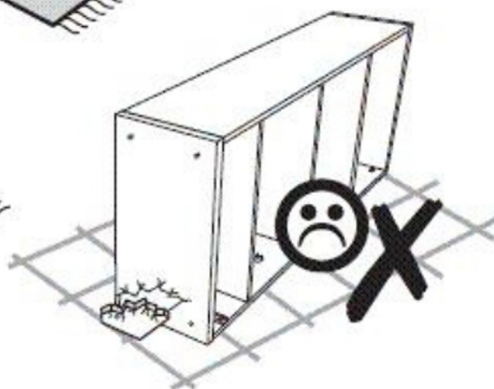
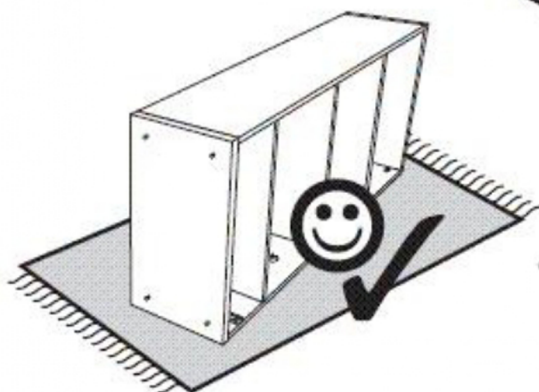
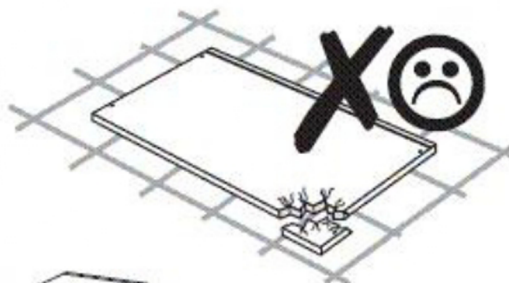
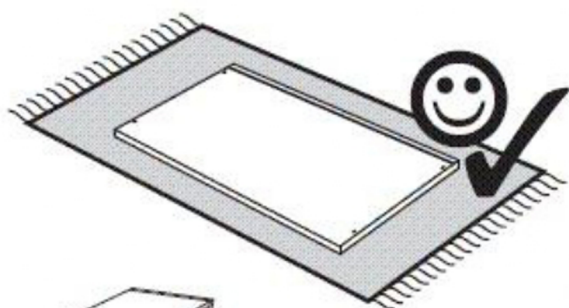
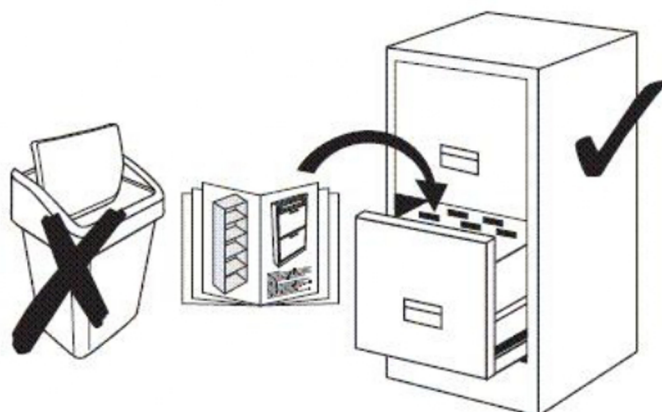
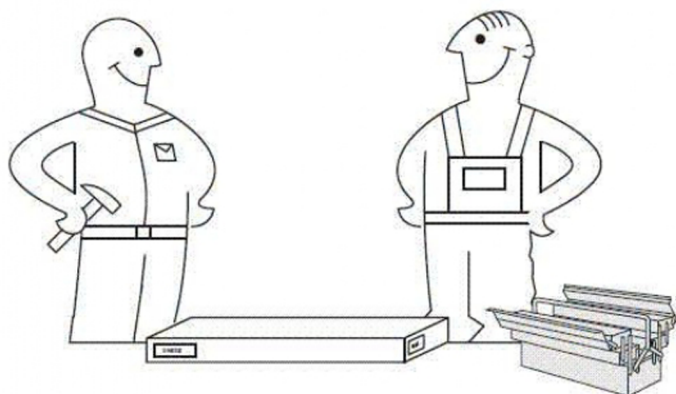

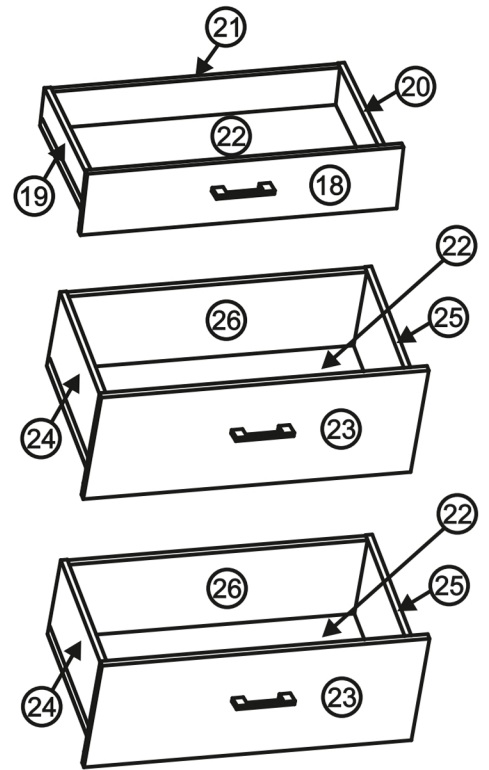
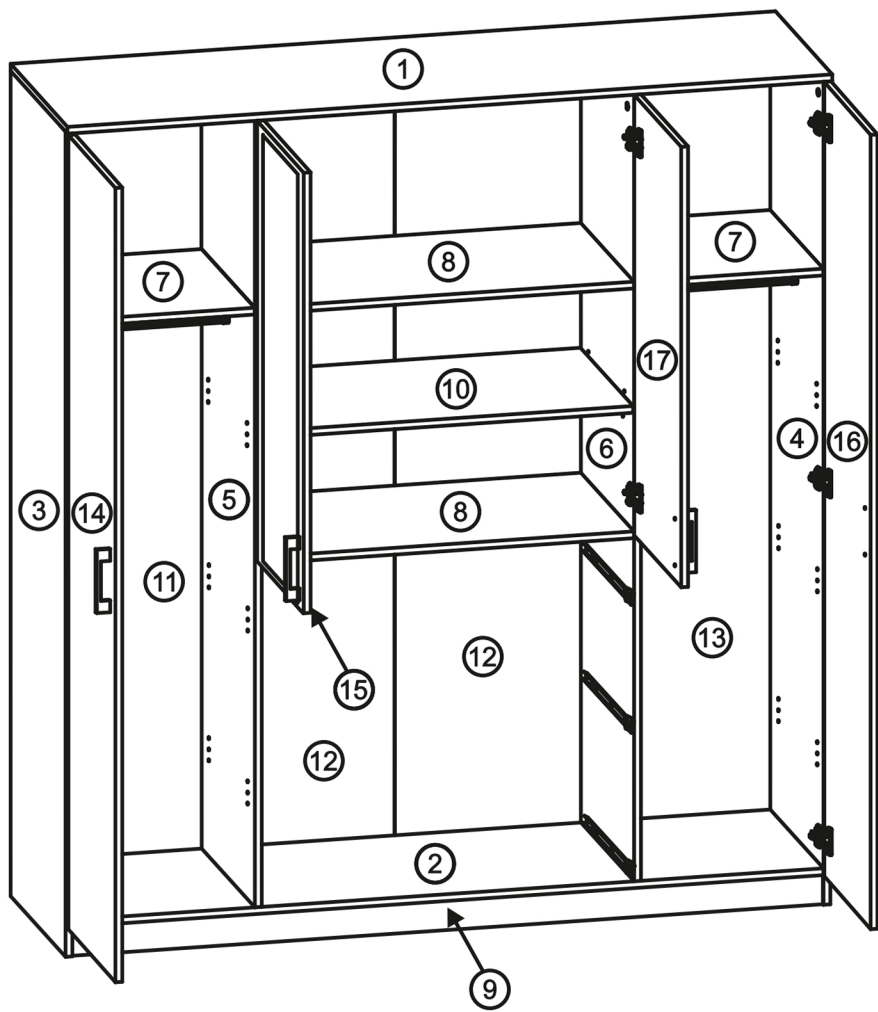

otočit - obrátiť / otočit - obrátit
okrenuti - ubrnuti
megfordítani - átfordítani
întoarceți - roțiți / otocte obratte









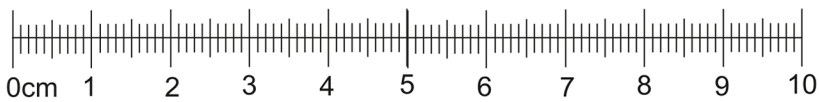
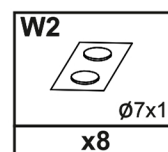
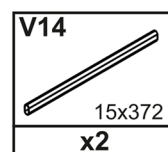
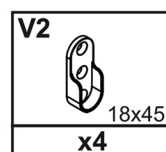
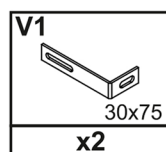
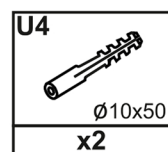
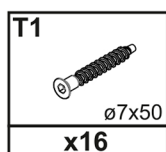
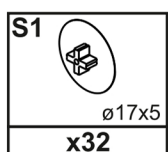
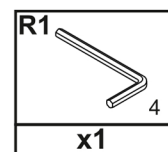
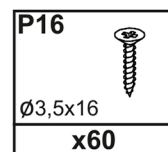
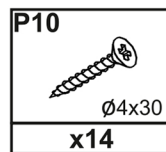
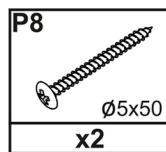
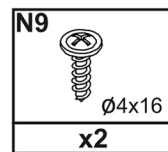
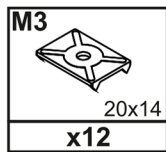
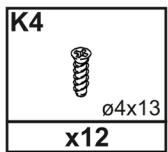
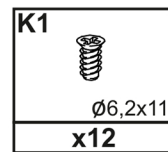
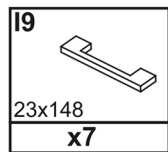
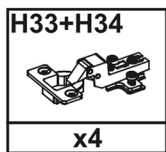
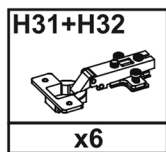
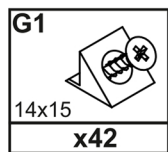
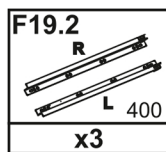
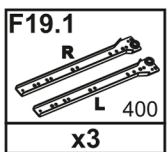
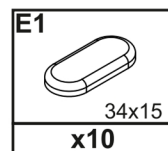
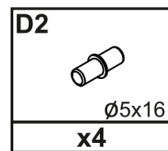
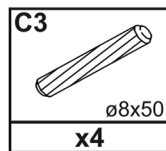
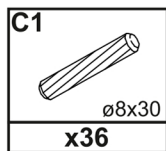
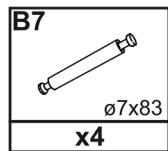
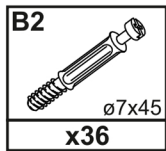
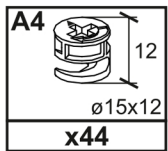
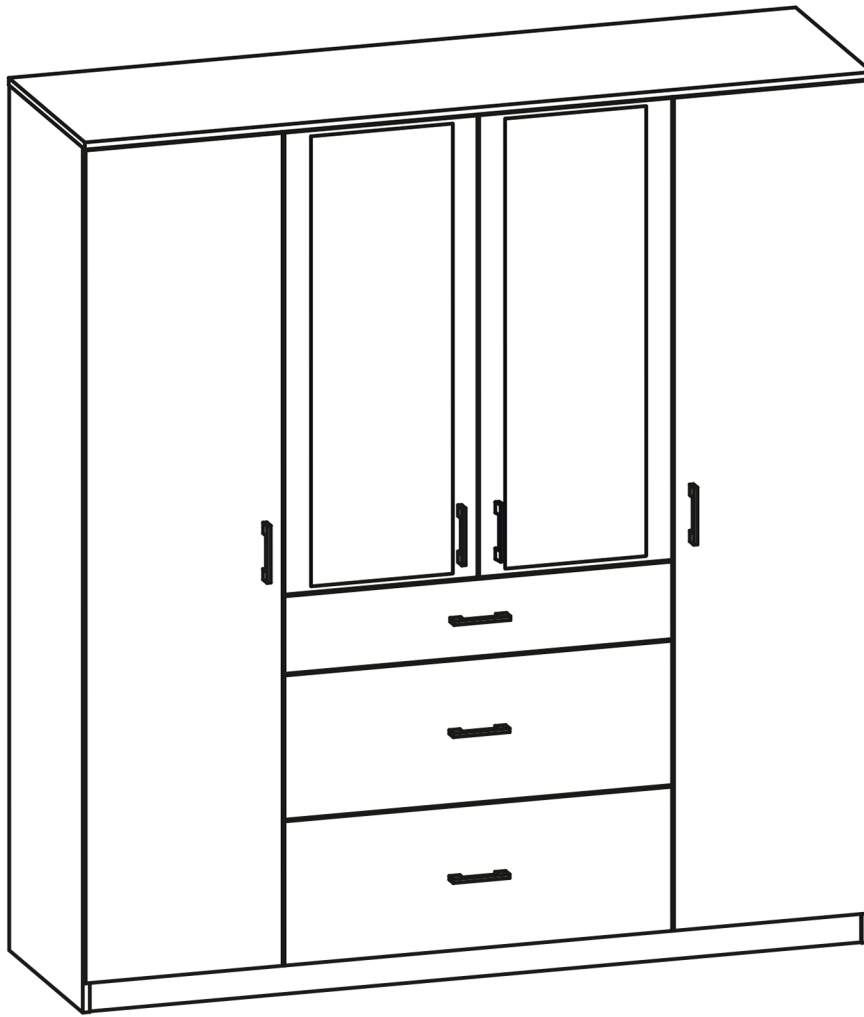

SK	Na čistenie nepoužívajte abrazívne čistiace prostriedky!
CZ	K čištění nepoužívejte abrazivní čisticí prostředky!
SI	Za čiščenje ne uporabljajte abrazivnih čistilnih sredstev!
HU	Ne használjon súroló hatású tisztítószereket a tisztításhoz!
HR	Za čišćenje nemojte koristiti abrazivna sredstva za čišćenje!
RO	Nu folosiți agenți de curățare abrazivi pentru curățare!

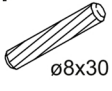

Nr.					
	A	B (mm)			C
1	1600	550	16	1x	4/5
2	1566	516	16	1x	4/5
3	1945	532	16	1x	2/5
4	1945	532	16	1x	2/5
5	1859	516	16	1x	5/5
6	1859	516	16	1x	5/5
7	515	376	16	2x	1/5
8	782	515	16	2x	4/5
9	1566	70	16	2x	3/5
10	781,5	505	16	1x	5/5
11	1884	392	3	1x	2/5
12	1884	396	3	2x	2/5
13	1884	392	3	1x	2/5

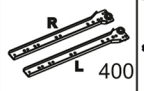
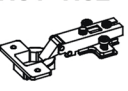



Nr.					
	A	B (mm)			C
14	1872	396	16	1x	3/5
15	1036	396	19	1x	1/5
16	1872	396	16	1x	3/5
17	1036	396	19	1x	1/5
18	795	175	16	1x	5/5
19	400	110	16	1x	1/5
20	400	110	16	1x	1/5
21	725	110	16	1x	3/5
22	735	393	3	3x	1/5
23	795	325	16	1x; 1x	3/5; 5/5
24	400	235	16	2x	1/5
25	400	235	16	2x	1/5
26	725	235	16	2x	3/5

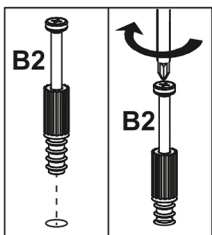
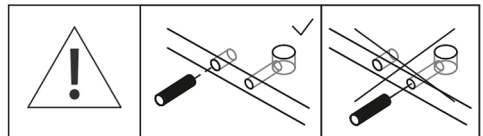
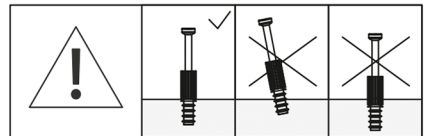
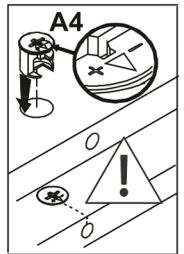
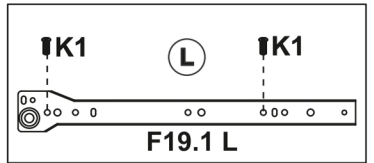
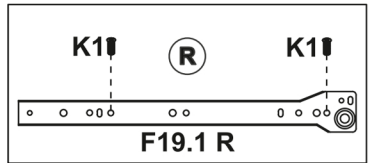
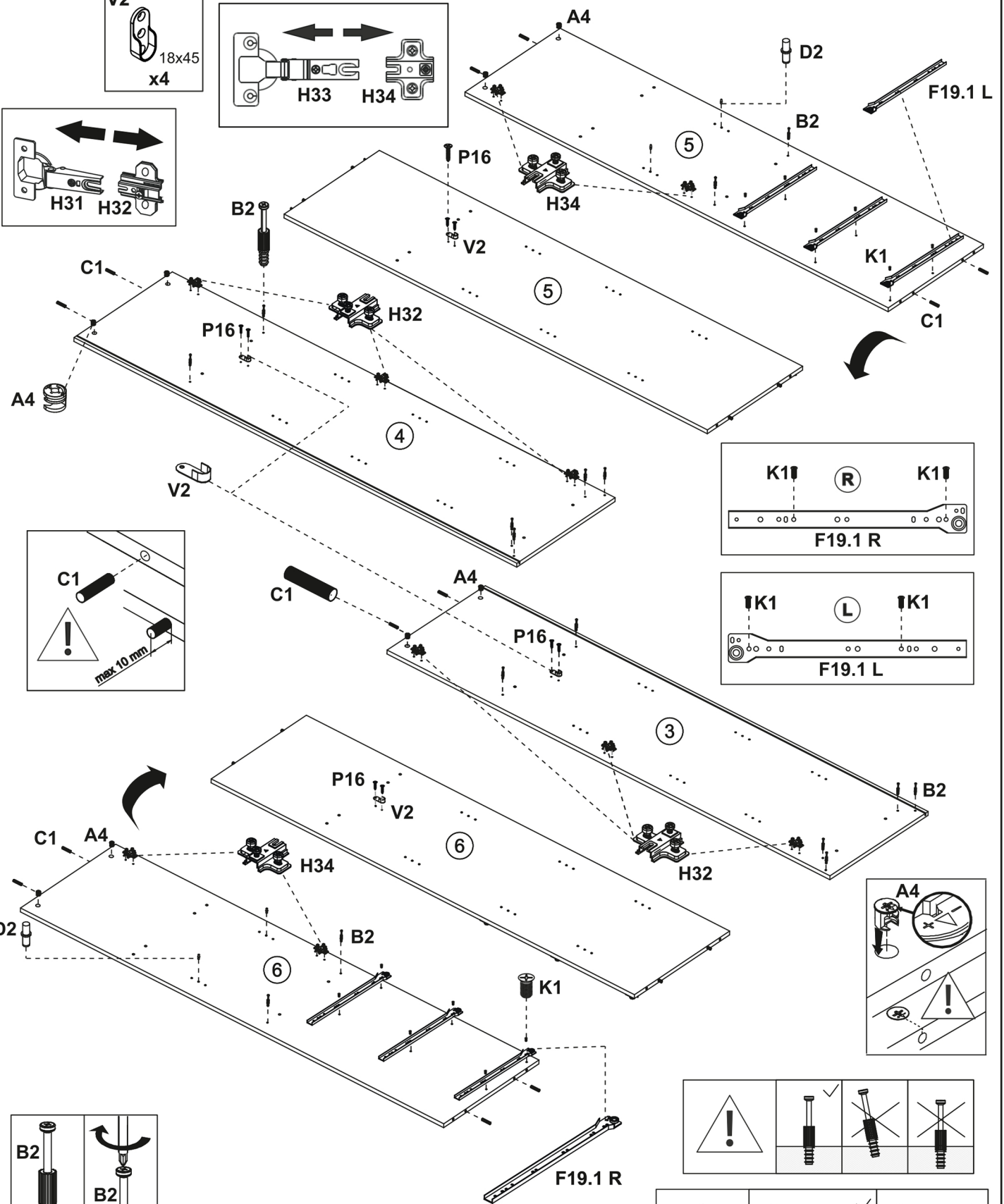
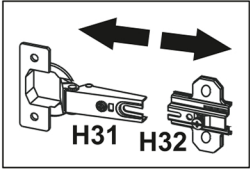
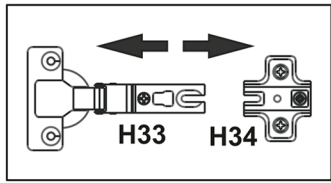
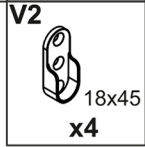

1	A4  12 x8	B2  ∅7x45 x16	C1  ∅8x30 x12	D2  ∅5x16 x4	F19.1  R L 400 x3	H31+H32  x6	H33+H34  x4	K1  ∅6,2x11 x12	P16  ∅3,5x16 x8
----------	--	--	--	---	---	--	---	--	--

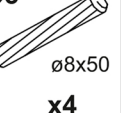

2

A4  x24	B2  x8	B7  x4	C1  x18	C3  x4
---	--	--	---	--

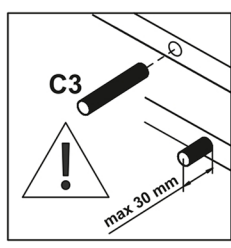
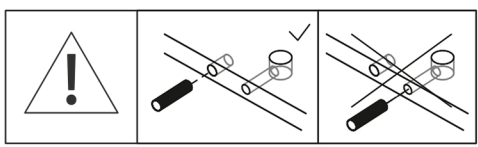
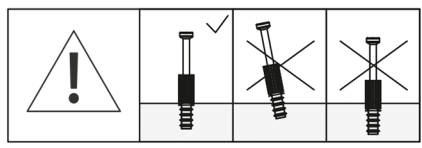
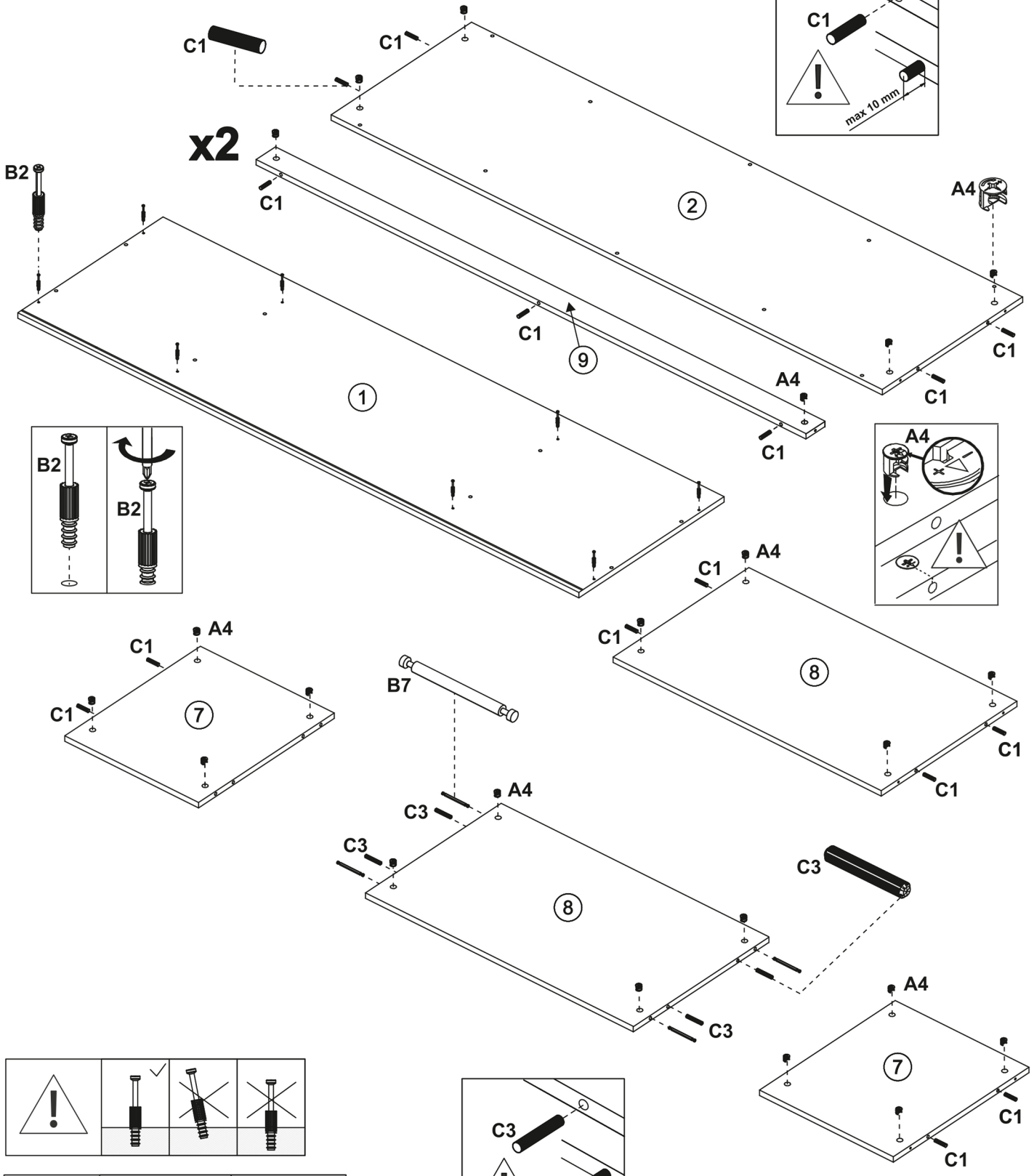

3

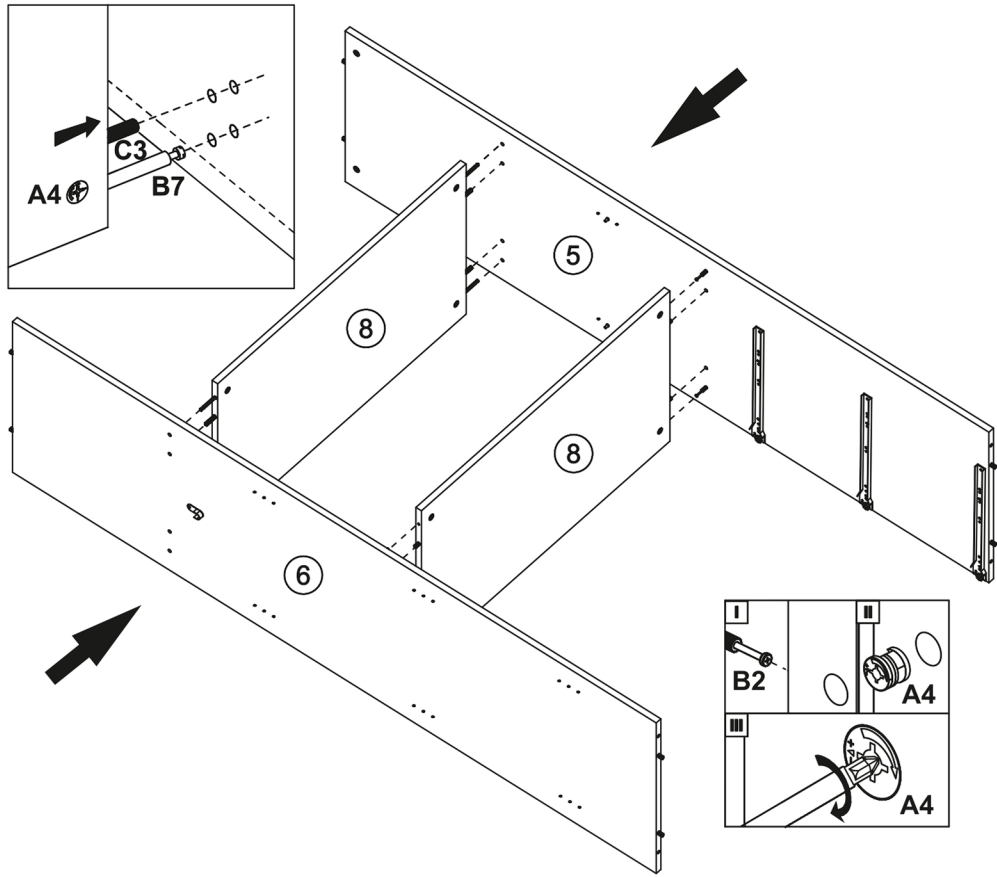

4 S1
ø17x5
x8

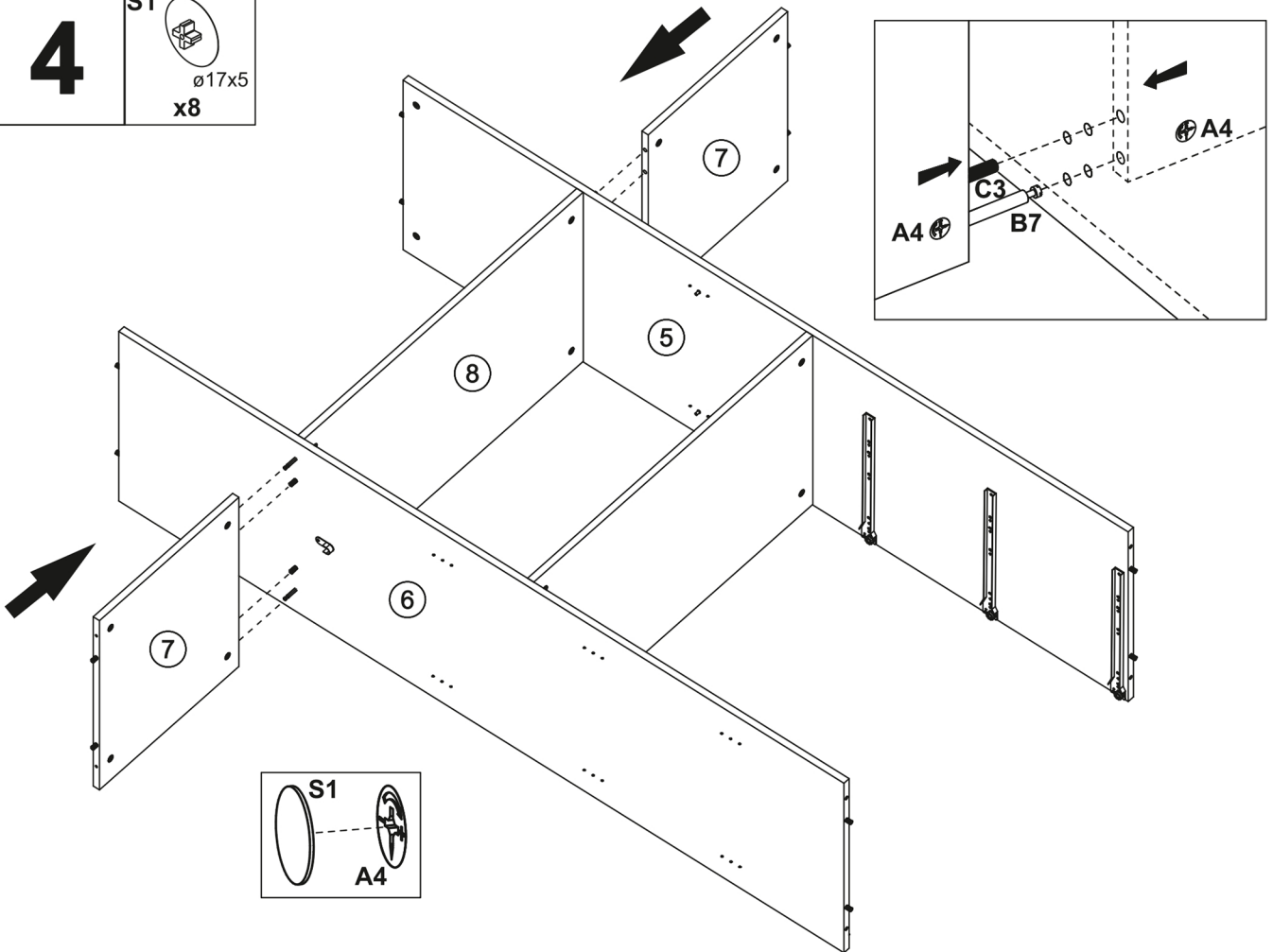

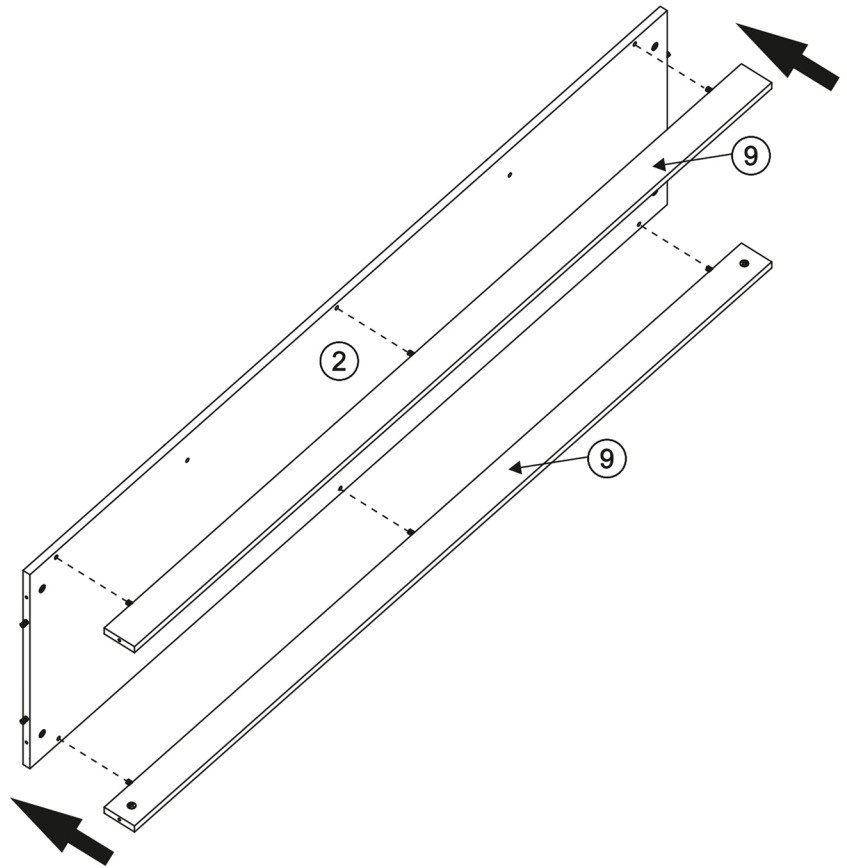

5



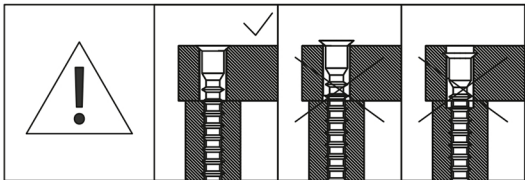
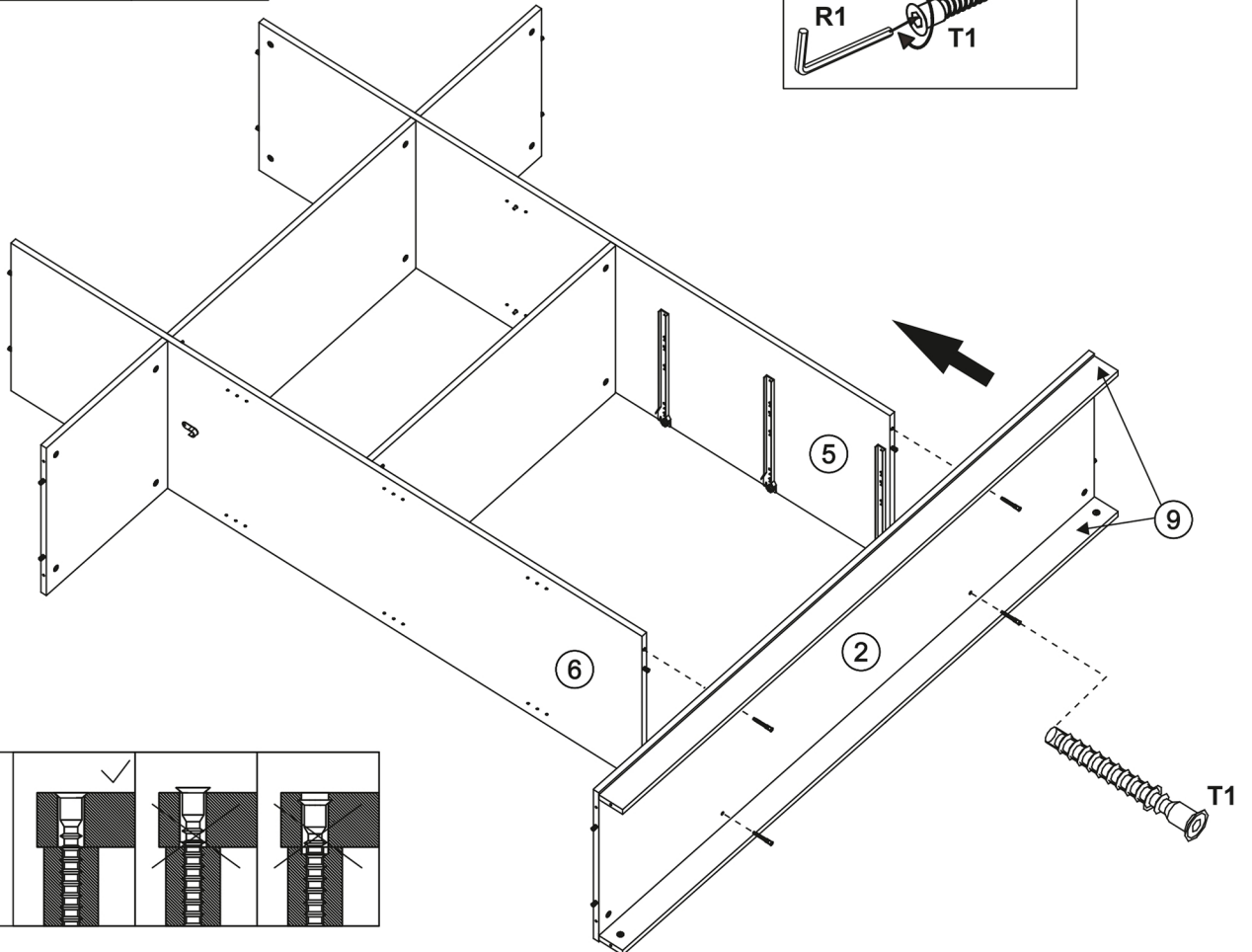
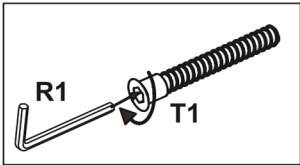

6

R1	T1
4	ø7x50
x1	x4

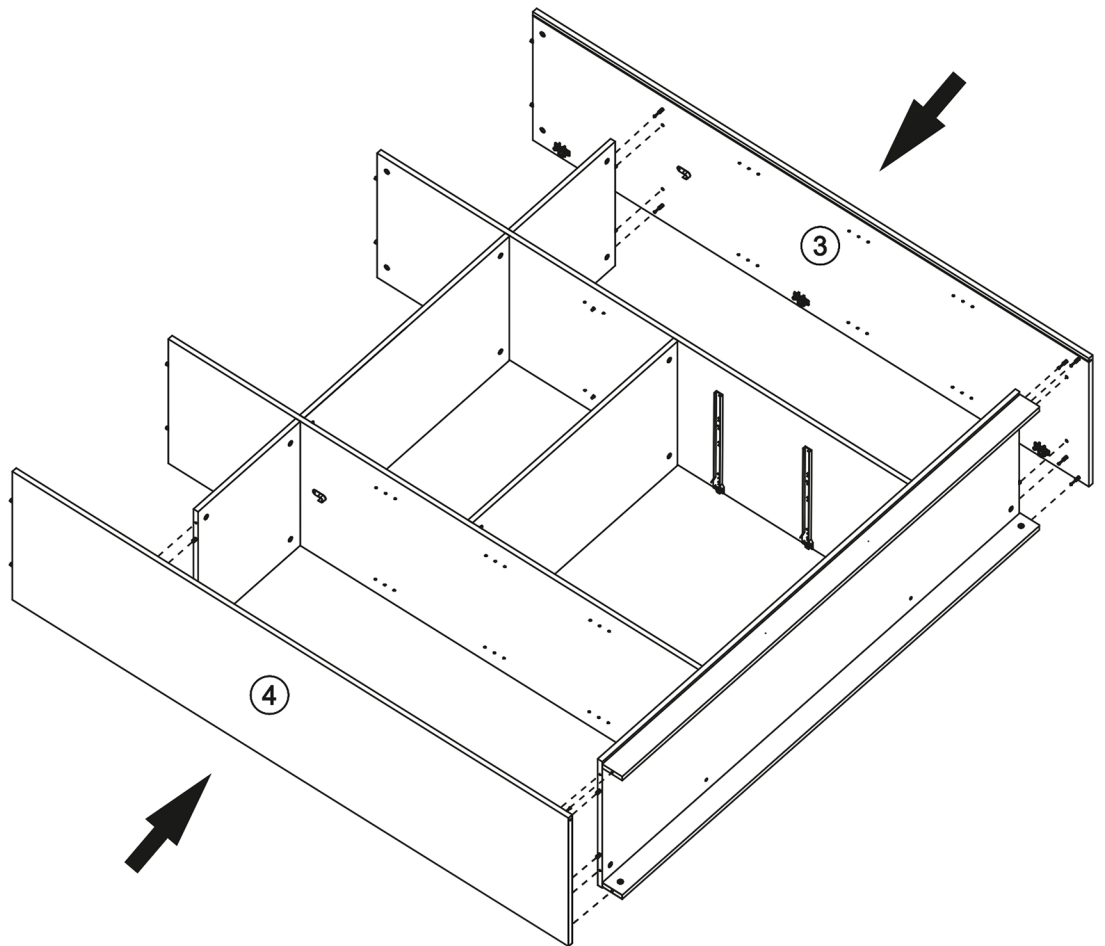
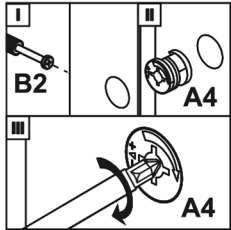
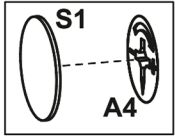

7 S1

 ø17x5
 x4



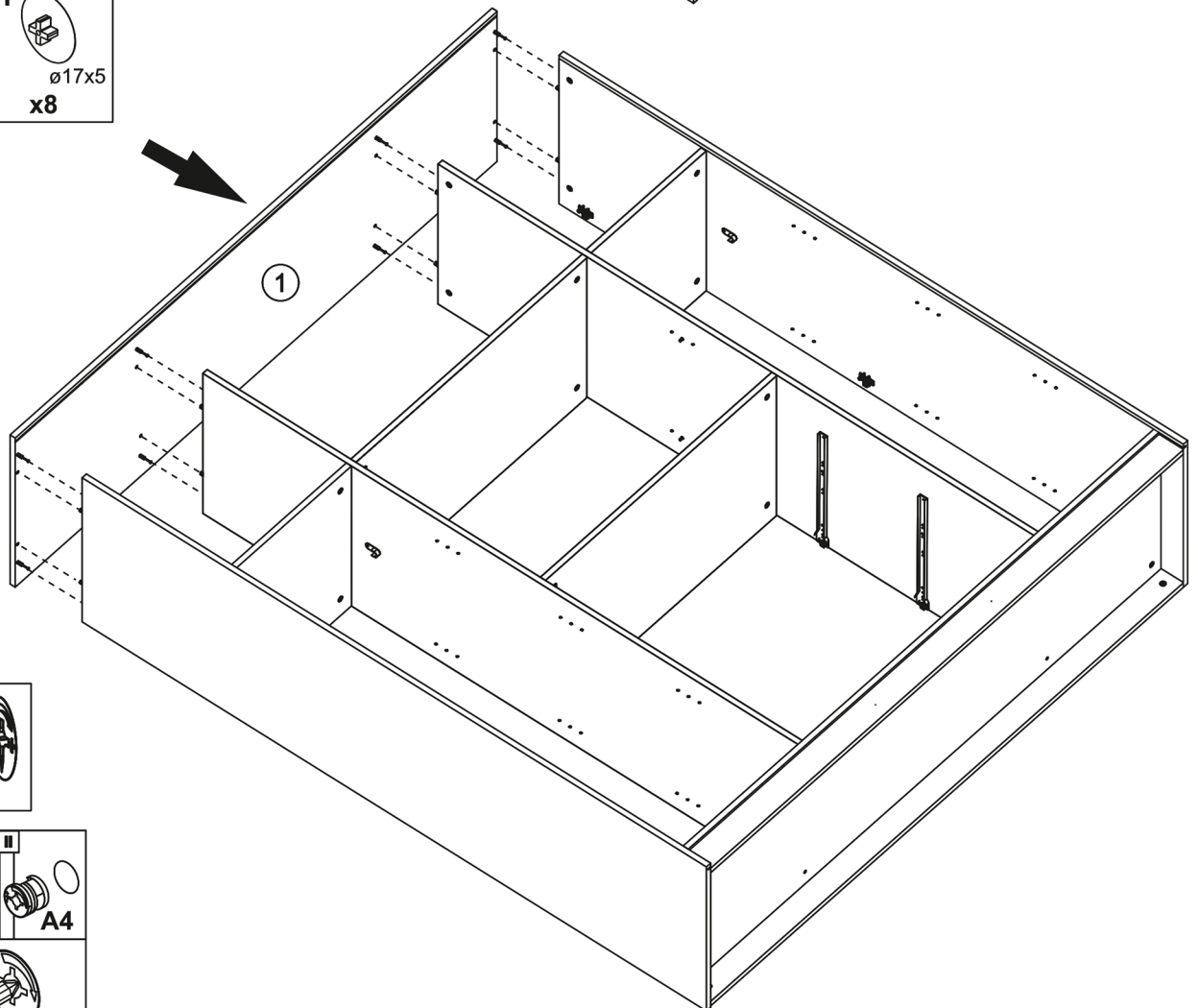
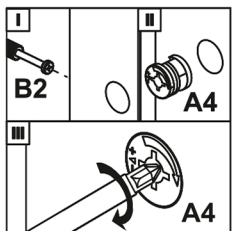
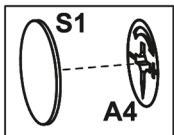

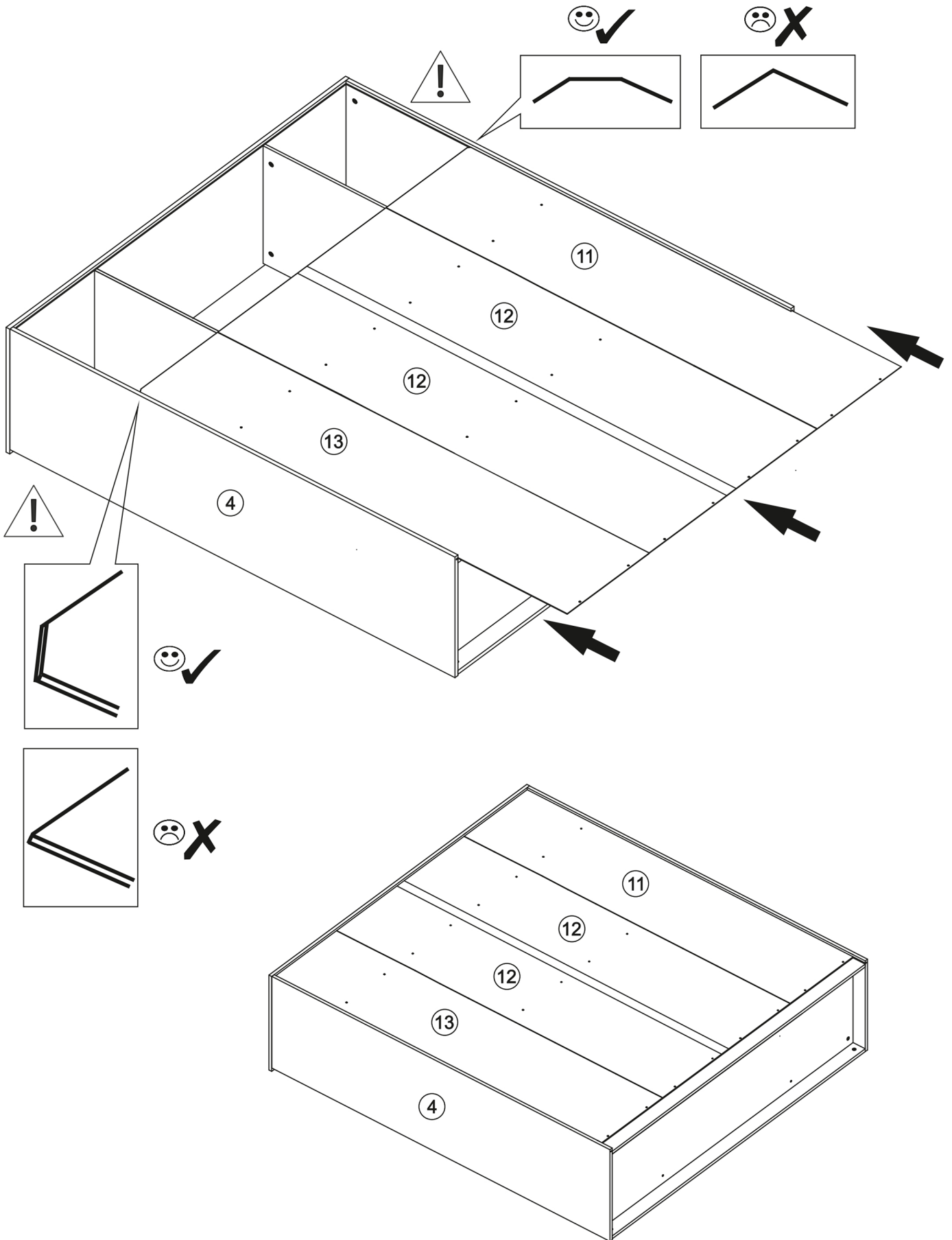

8 S1

 ø17x5
 x8



9



10

E1  34x15 x10	G1  14x15 x12	M3  20x14 x12	P16  Ø3,5x16 x32
--	--	--	---

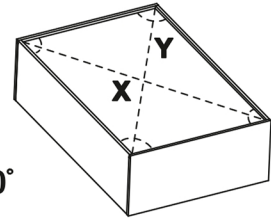
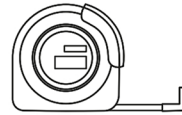



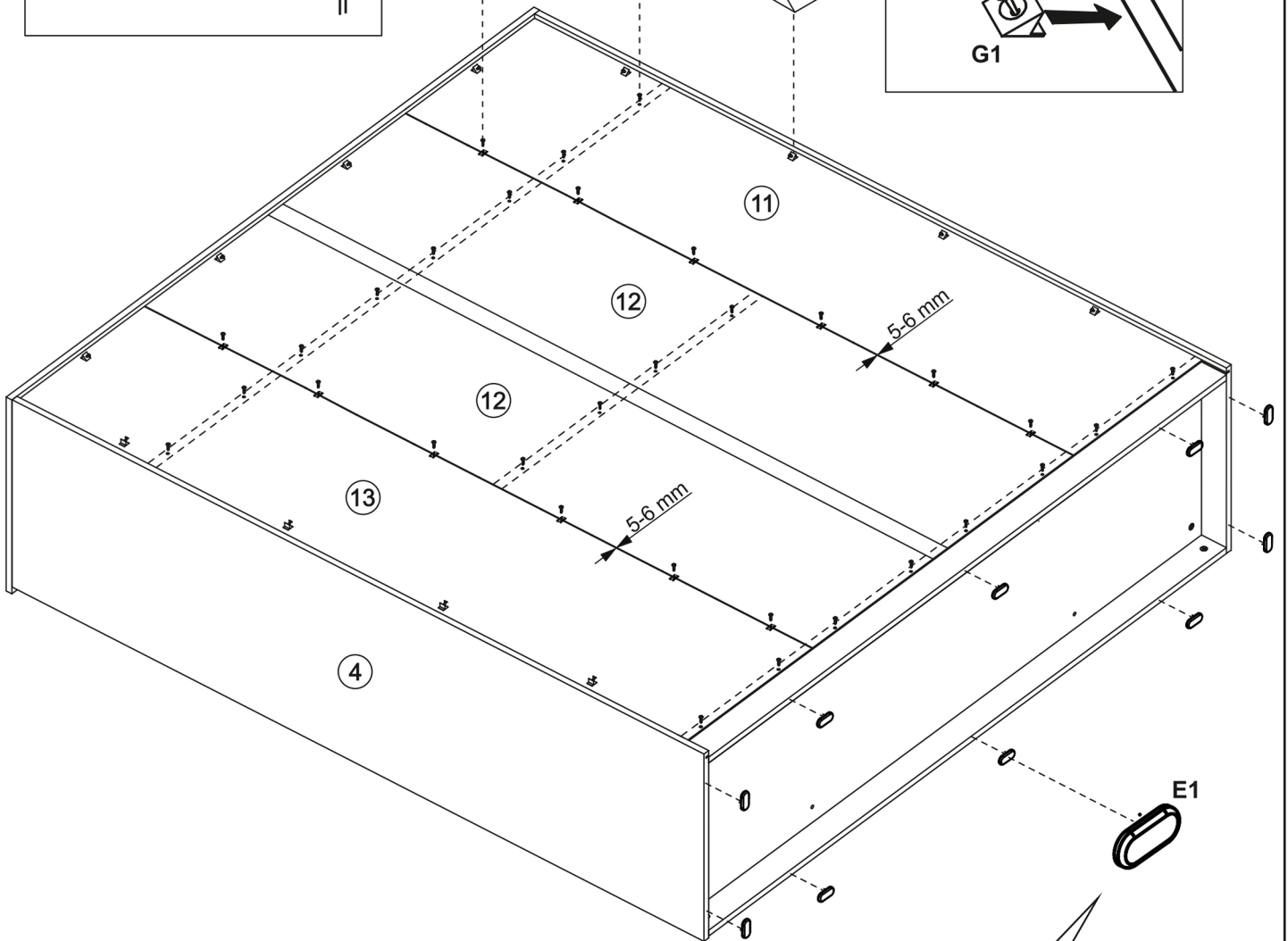
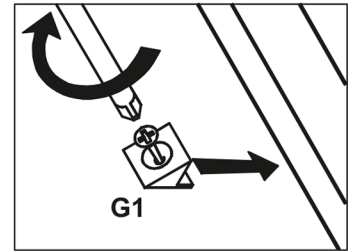
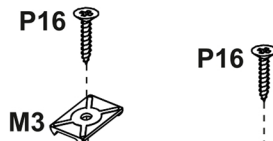
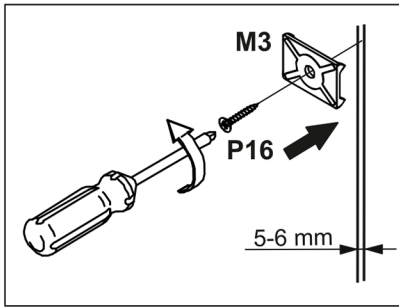



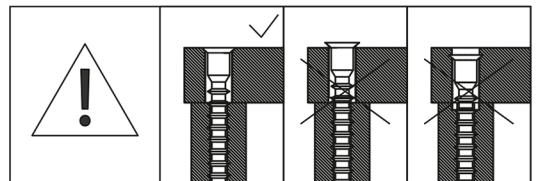
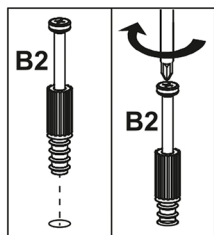
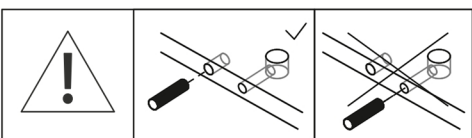
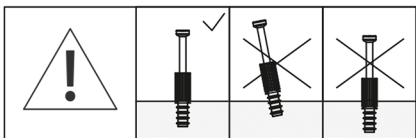
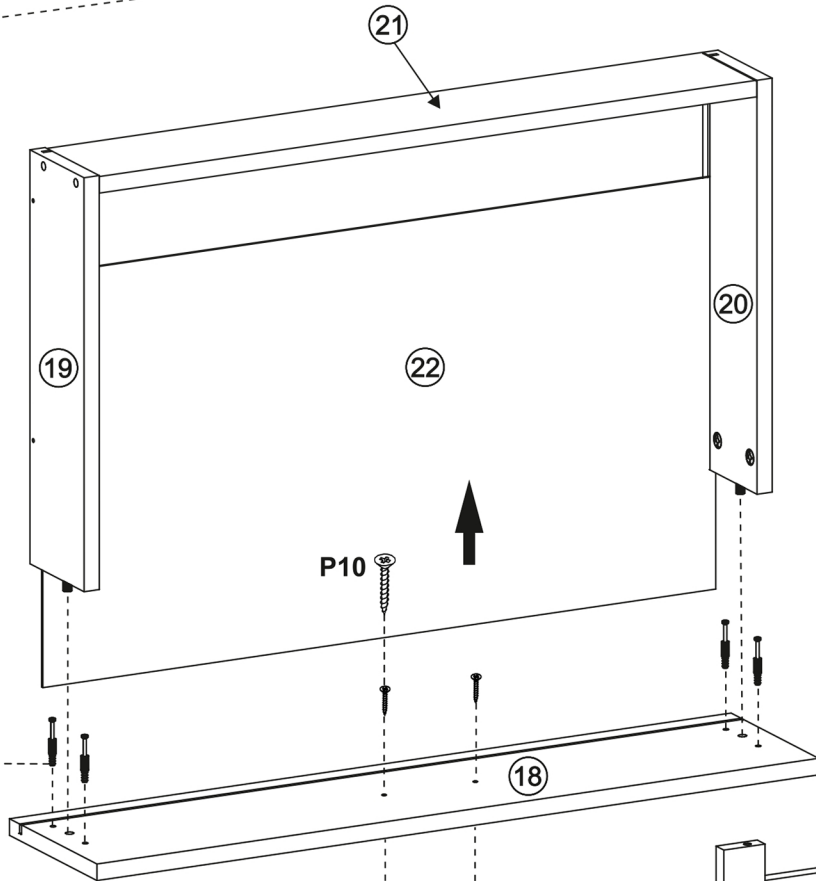
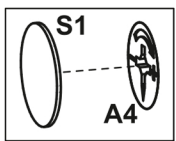
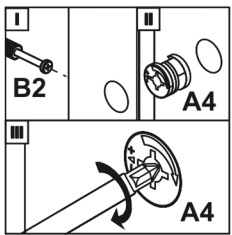
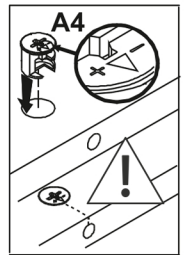
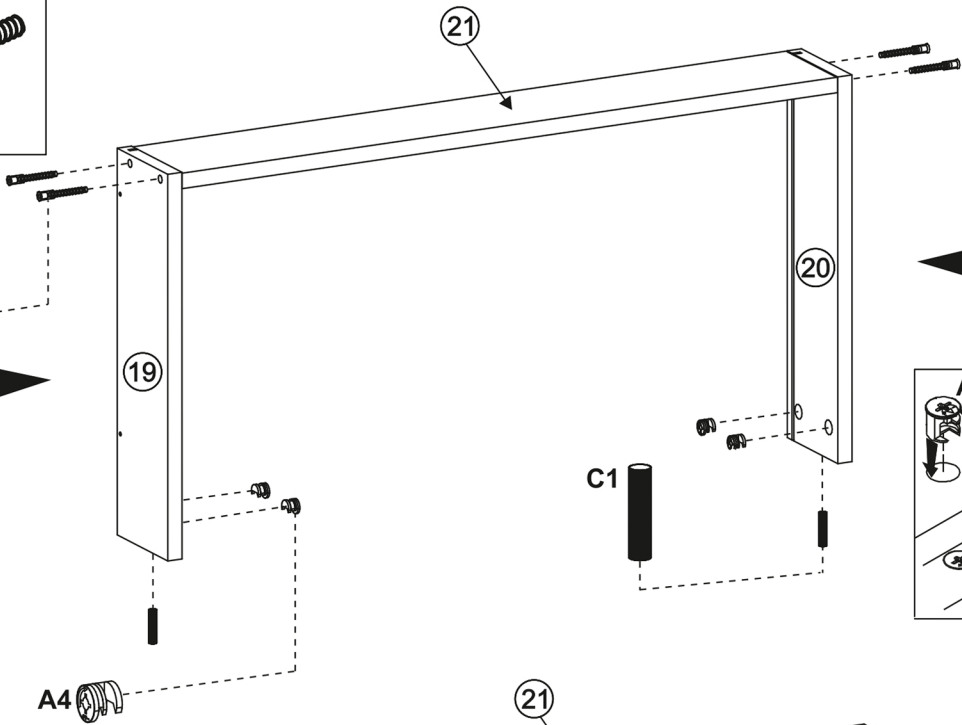
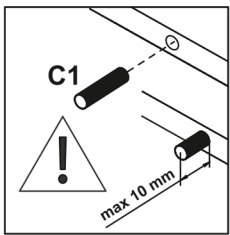
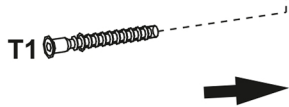
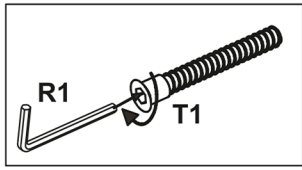

$X=Y=90^\circ$

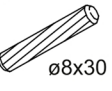

11	A4 12 x4	B2 ø7x45 x4	C1 ø8x30 x2	I9 23x148 x1	P10 ø4x30 x2	R1 4 x1	S1 ø17x5 x4	T1 ø7x50 x4
-----------	-----------------------	--------------------------	--------------------------	---------------------------	---------------------------	----------------------	--------------------------	--------------------------



12	A4  12 x8	B2  ø7x45 x8	C1  ø8x30 x4	I9  23x148 x2	P10  ø4x30 x4	R1  4 x1	S1  ø17x5 x8	T1  ø7x50 x8
-----------	--	---	---	--	--	--	---	---

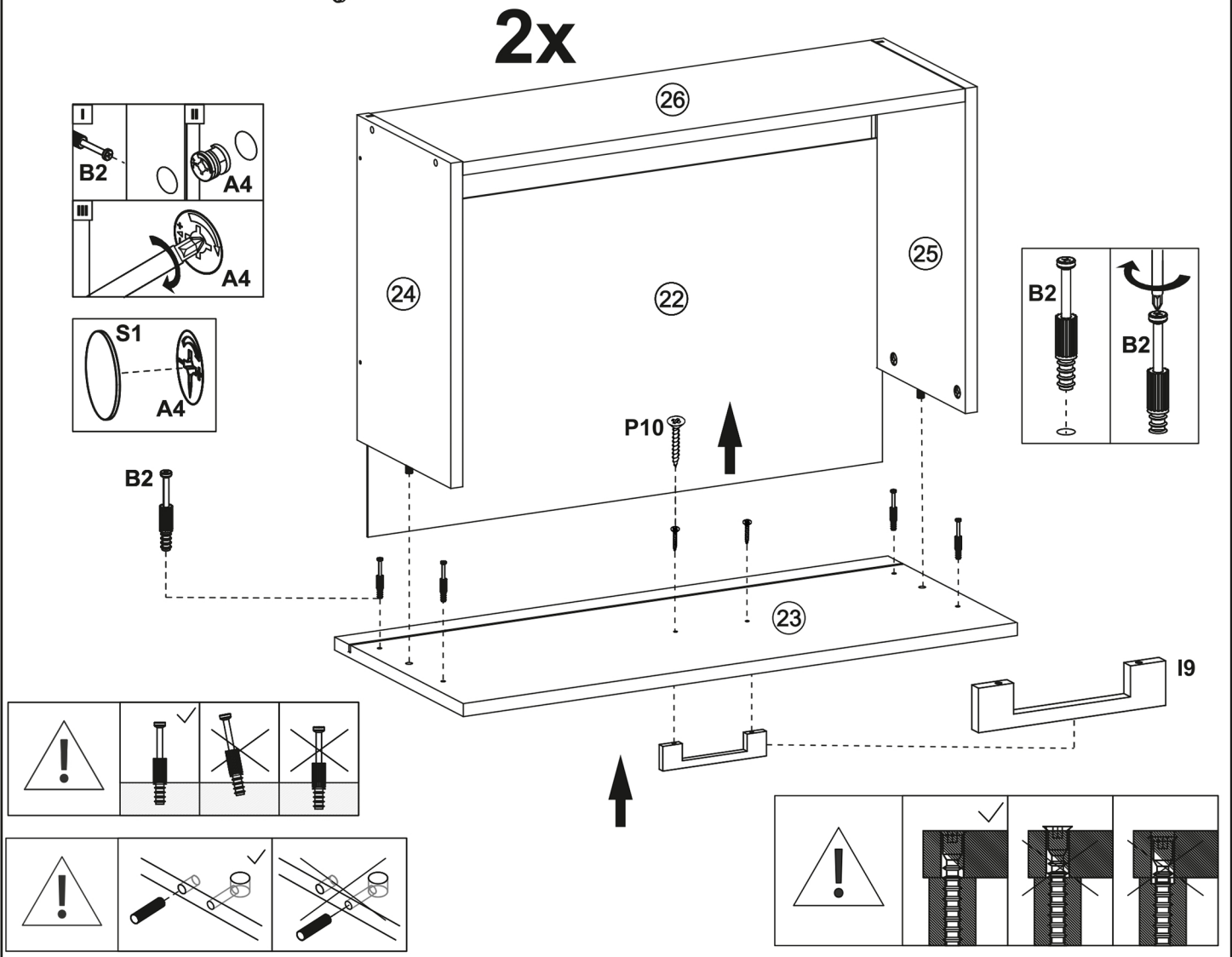
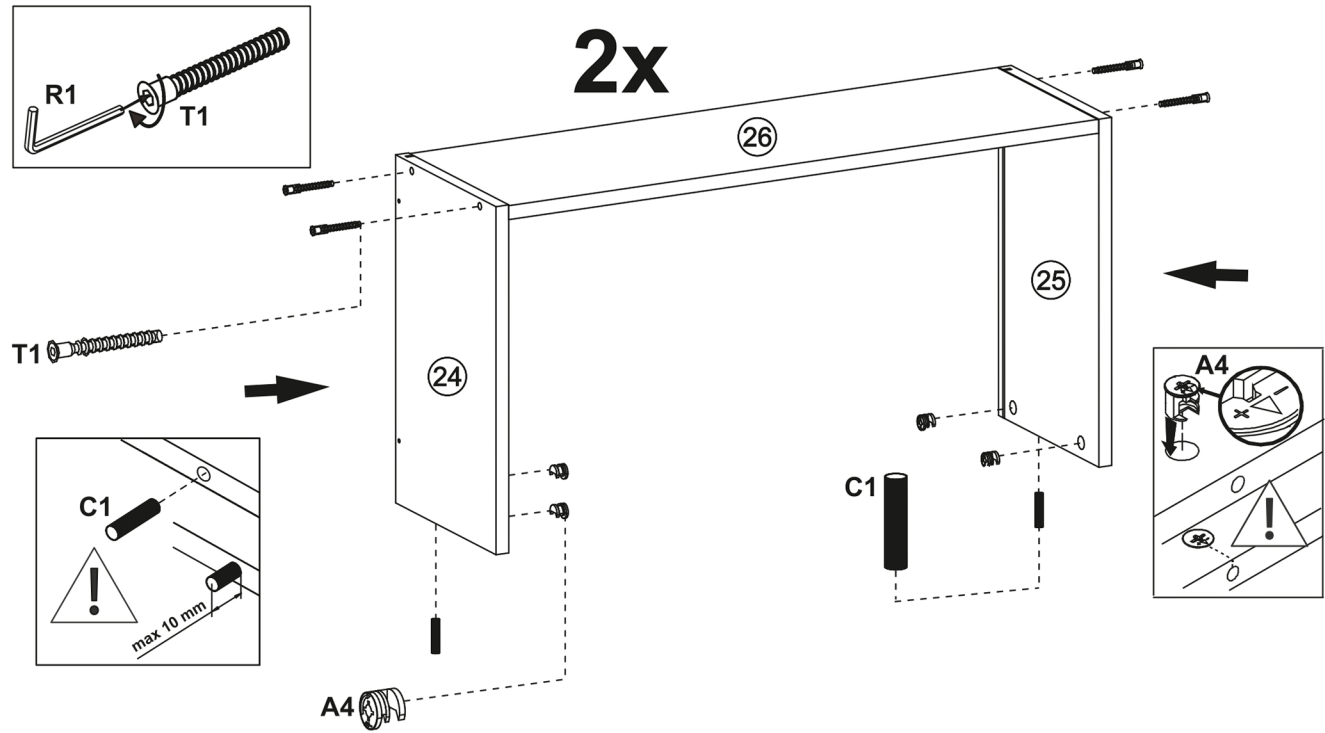

13



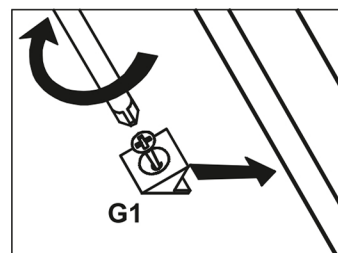
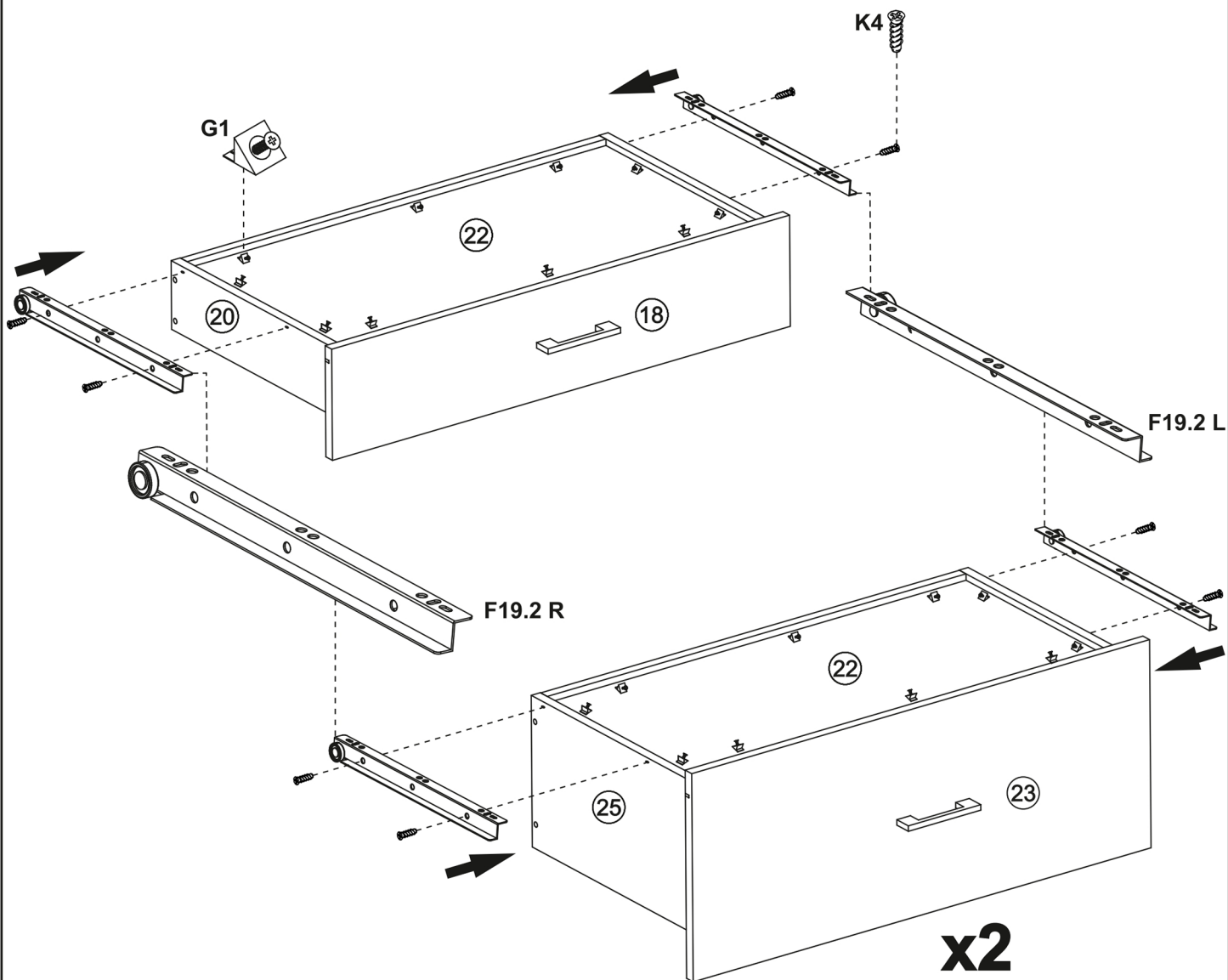

F19.2
R
L 400
x3

G1
14x15
x30

K4
ø4x13
x12



14



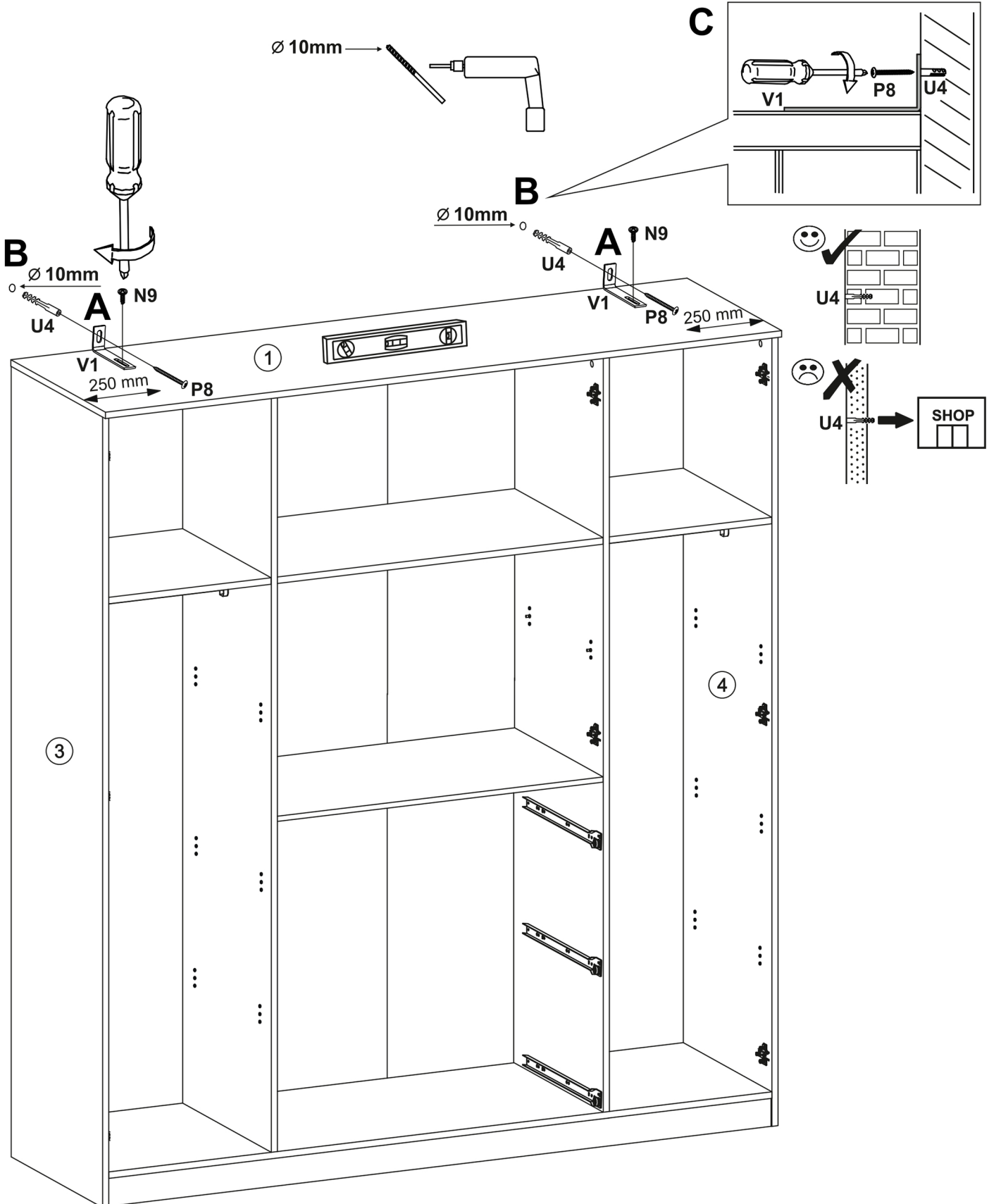
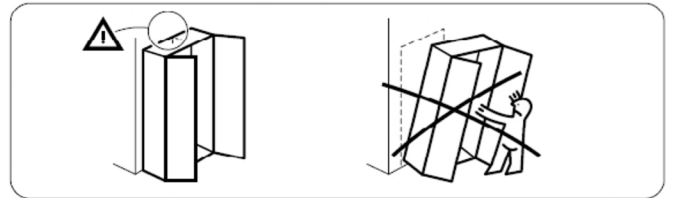

N9  Ø4x16 x2	P8  Ø5x50 x2	U4  Ø10x50 x2	V1  30x75 x2
---	---	--	---

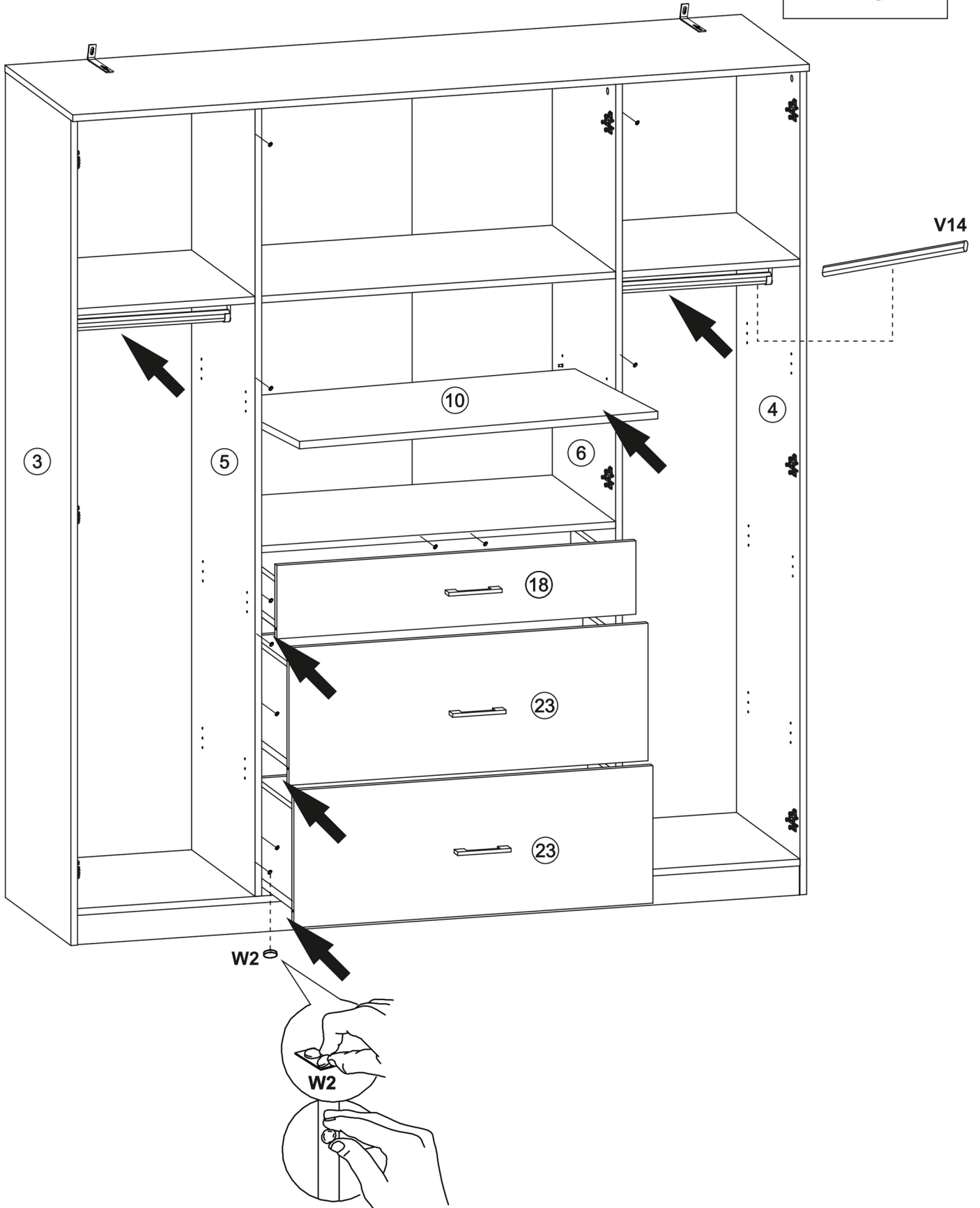
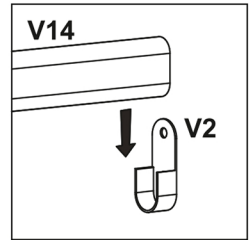

15	V14	W2
	15x372 x2	Ø7x1 x8

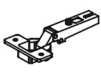
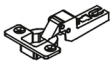

16

H31  x6	H33  x4	I9  23x148 x4	P10  Ø4x30 x8	P16  Ø3,5x16 x20
---	---	--	--	---

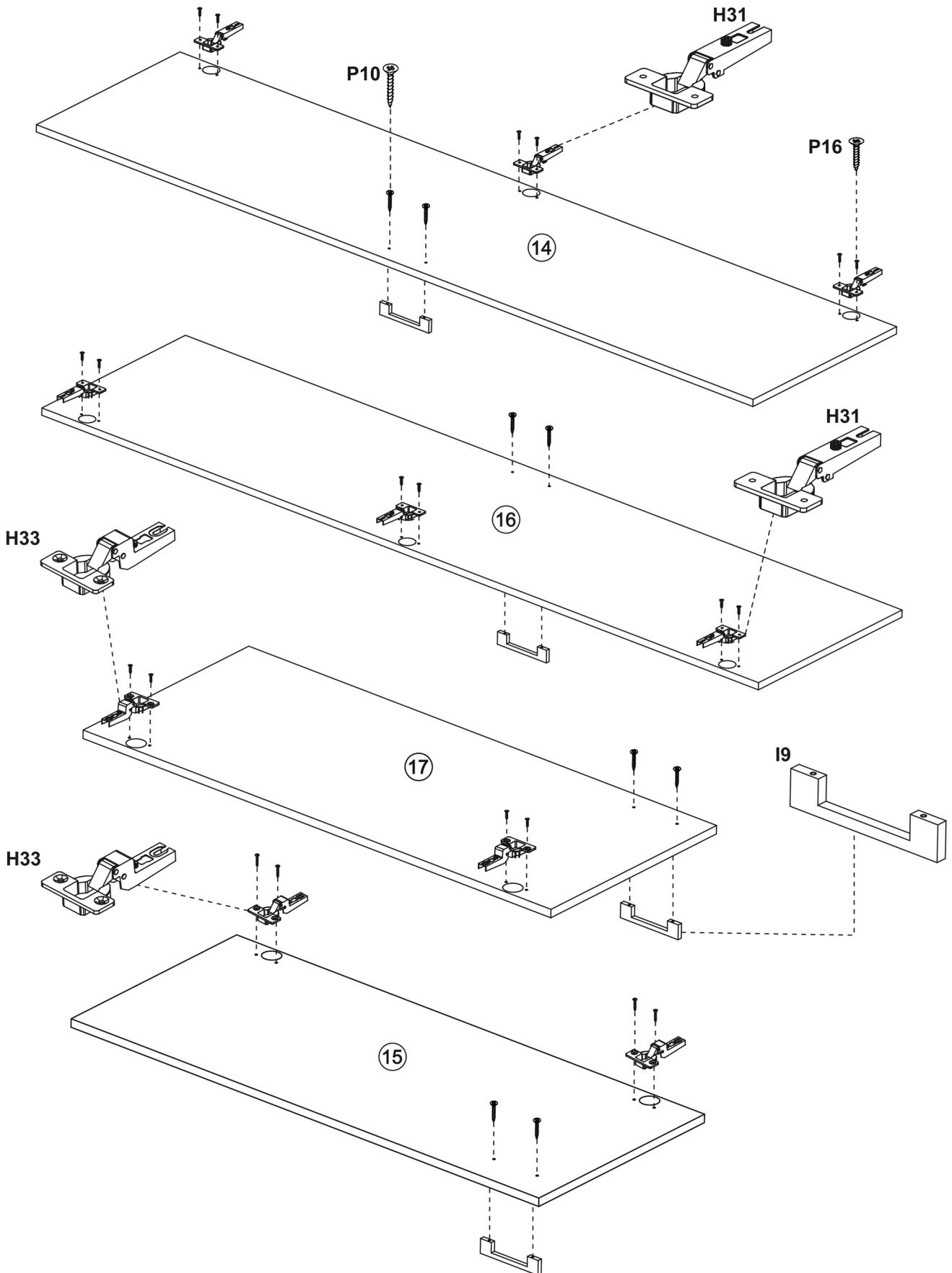

17

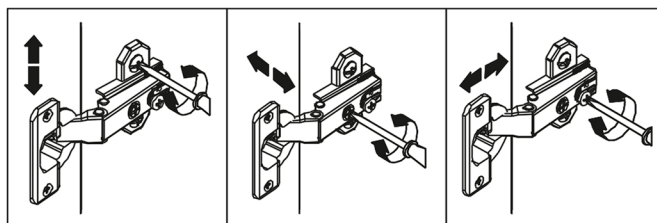
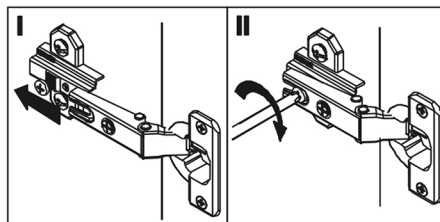
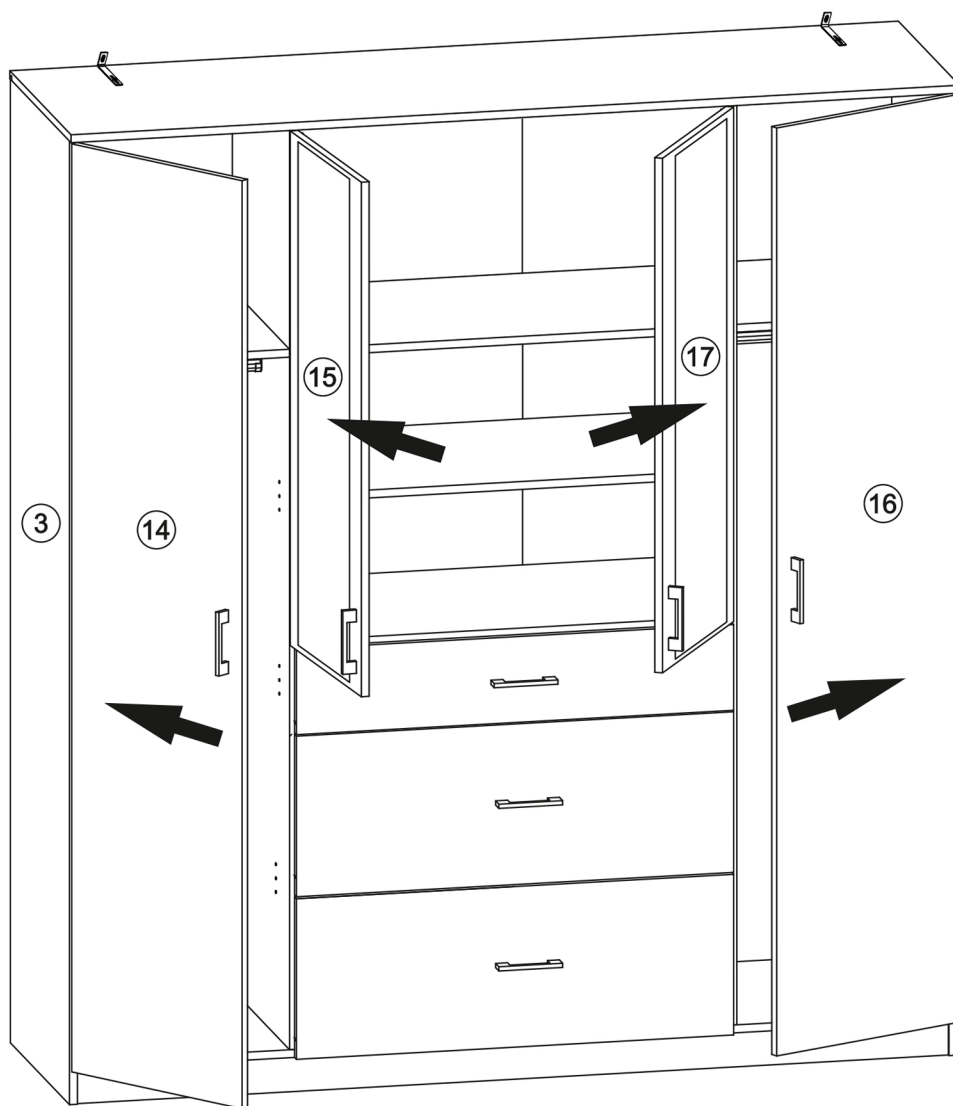

18

