

# MEDY

R

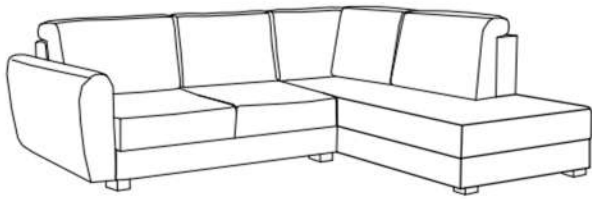

L

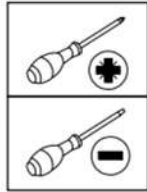
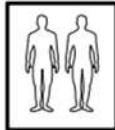
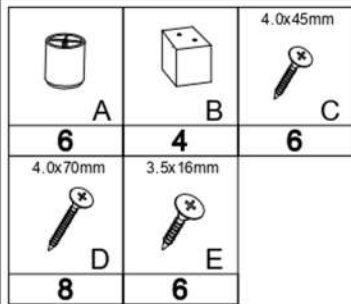
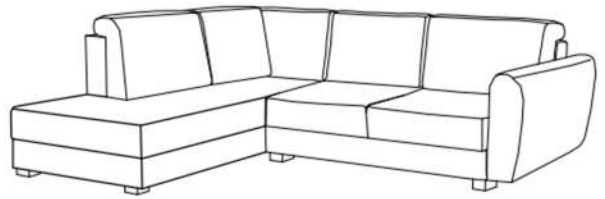

✓ OK

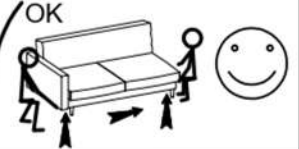

#	
1	1
2	1
3	1
4	1
5	3
6	1
7	1

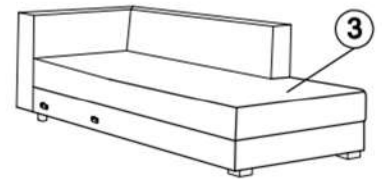
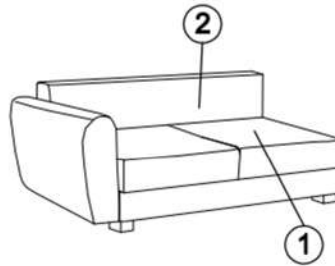
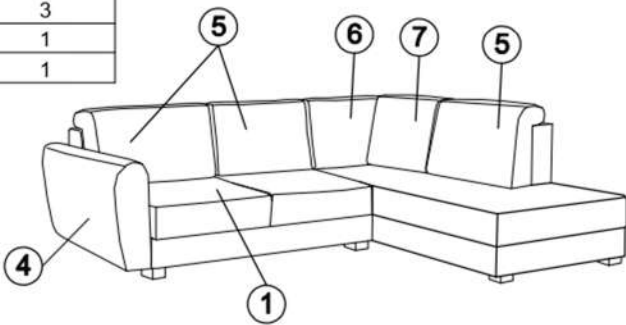

1

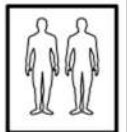
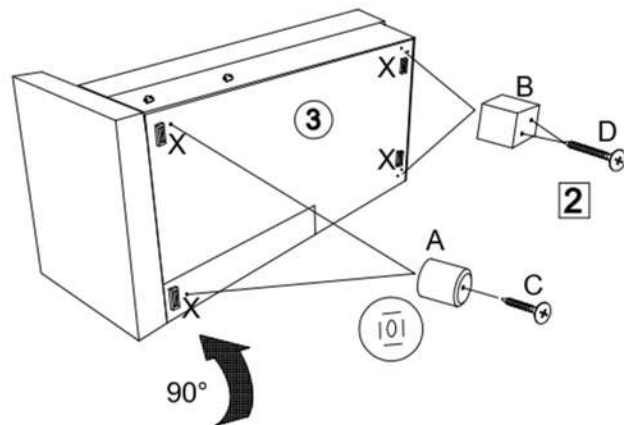
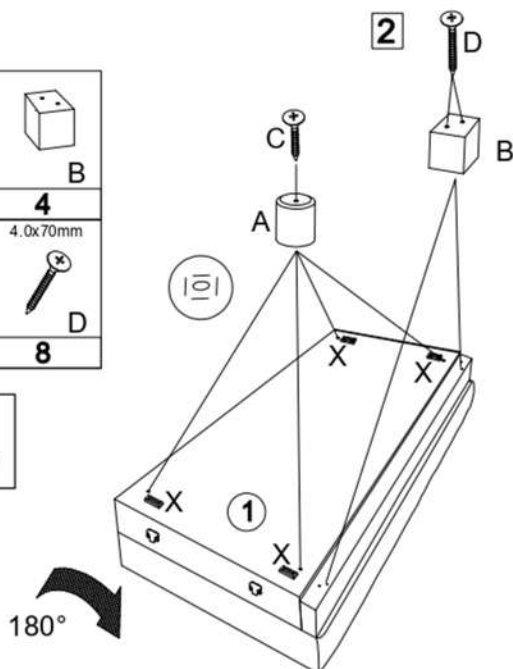
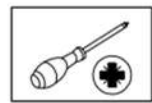
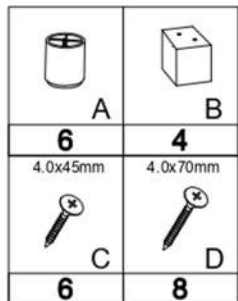

2

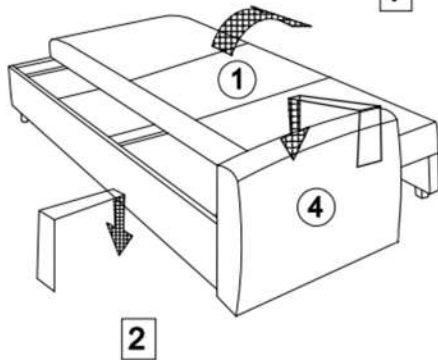
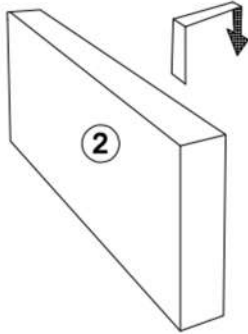
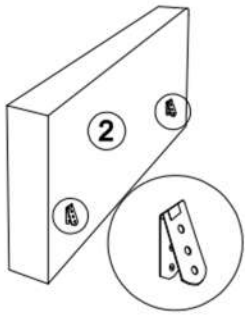
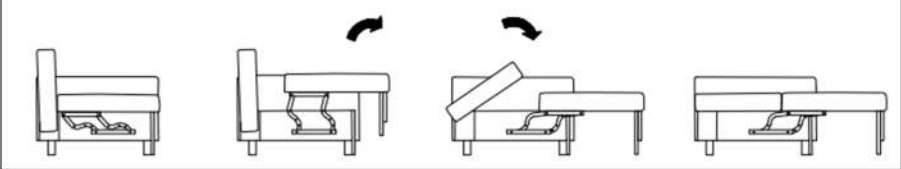
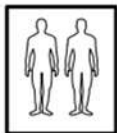
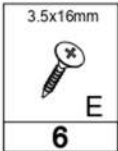

1

3

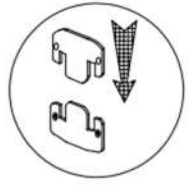

2

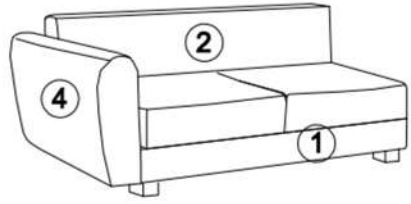
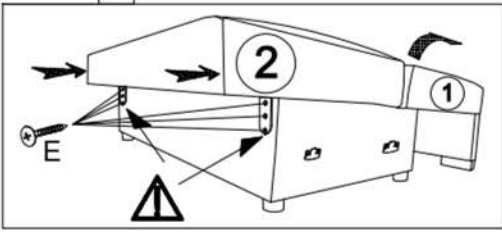

3

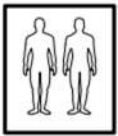
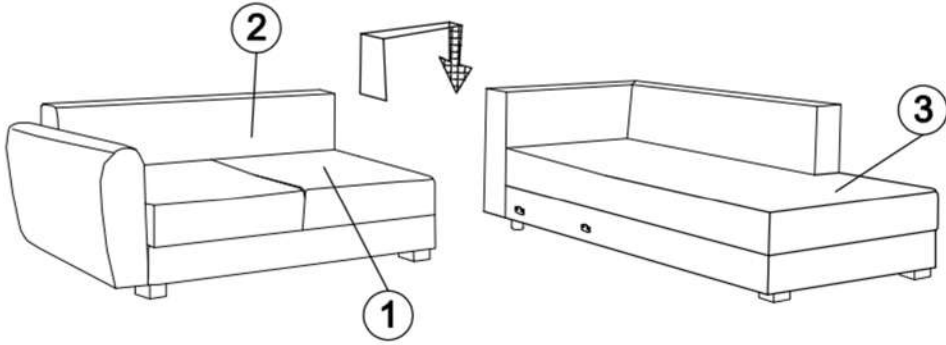

4

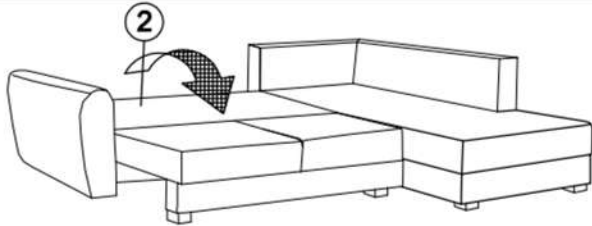
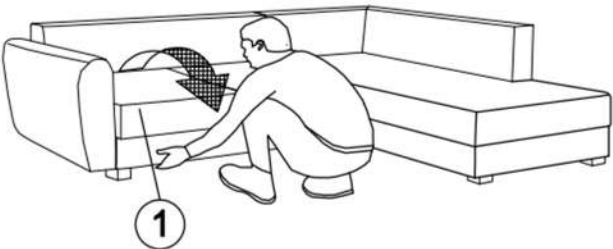
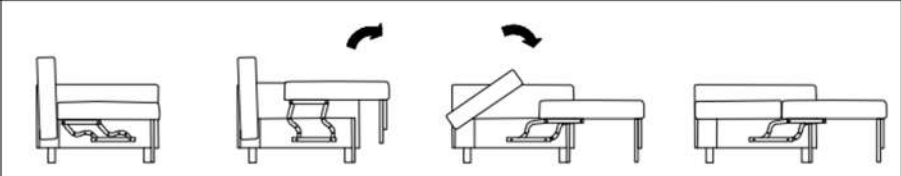

5

