

LORAM

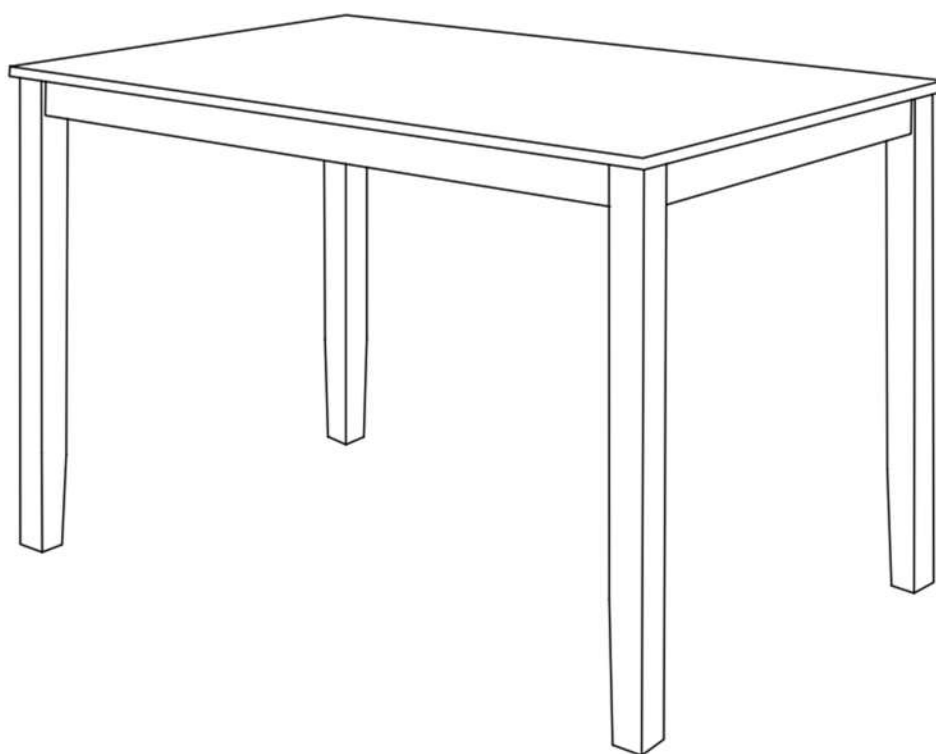

0000415830



A

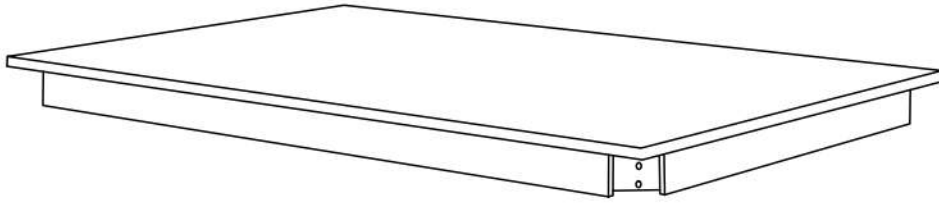

X1

B

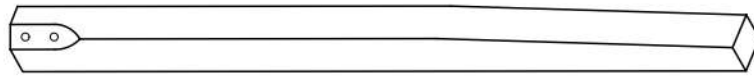

X4

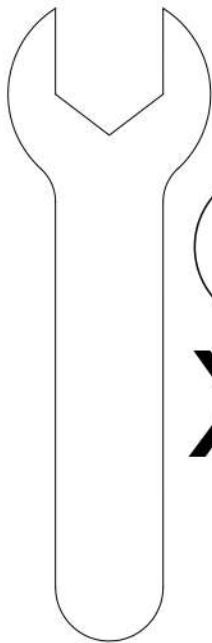

1

X1

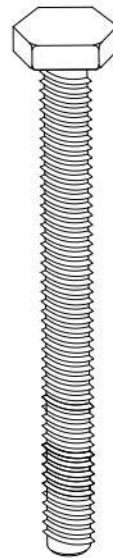

2

X8

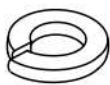

3

X8

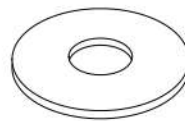

4

X8

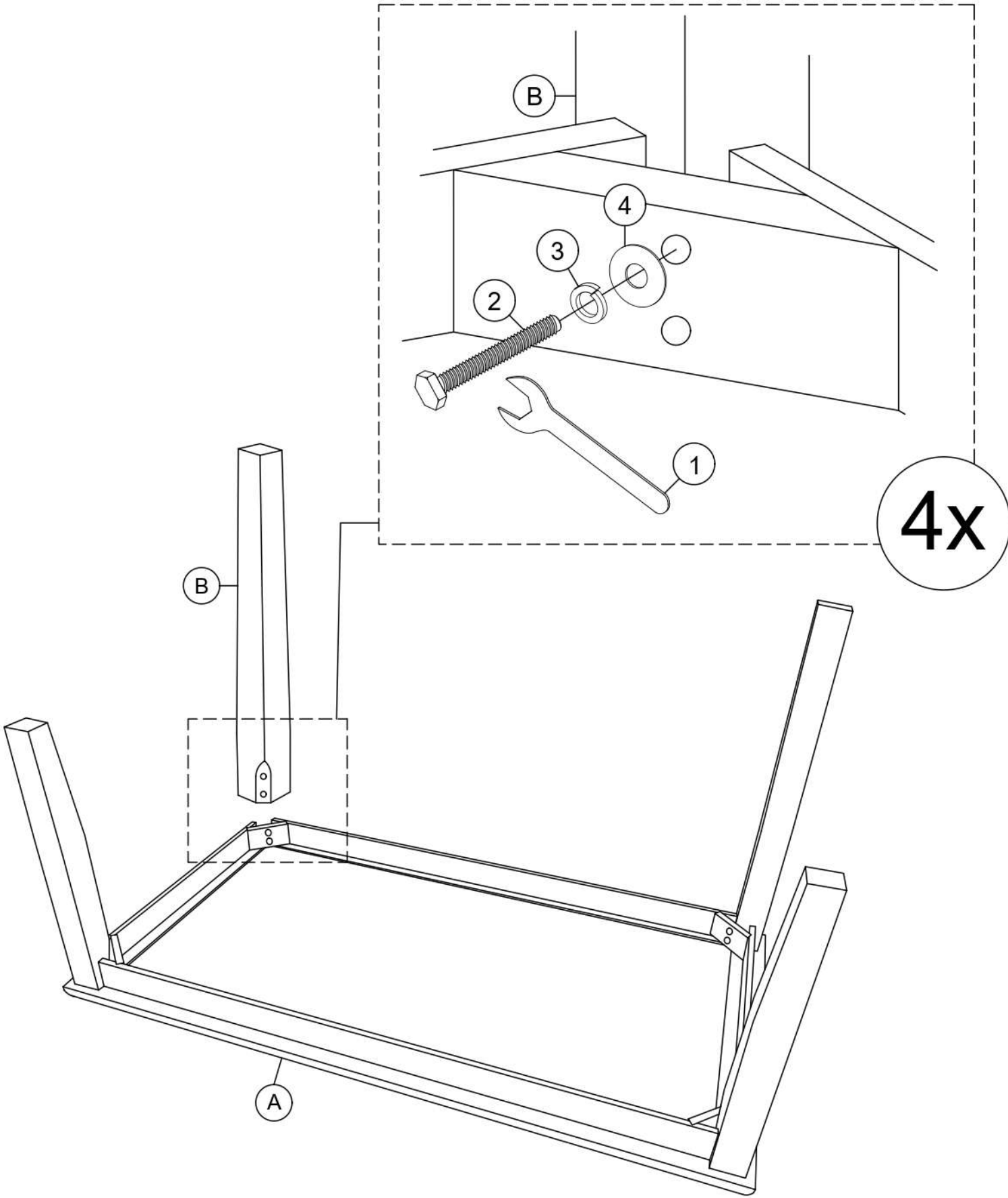

LORAM

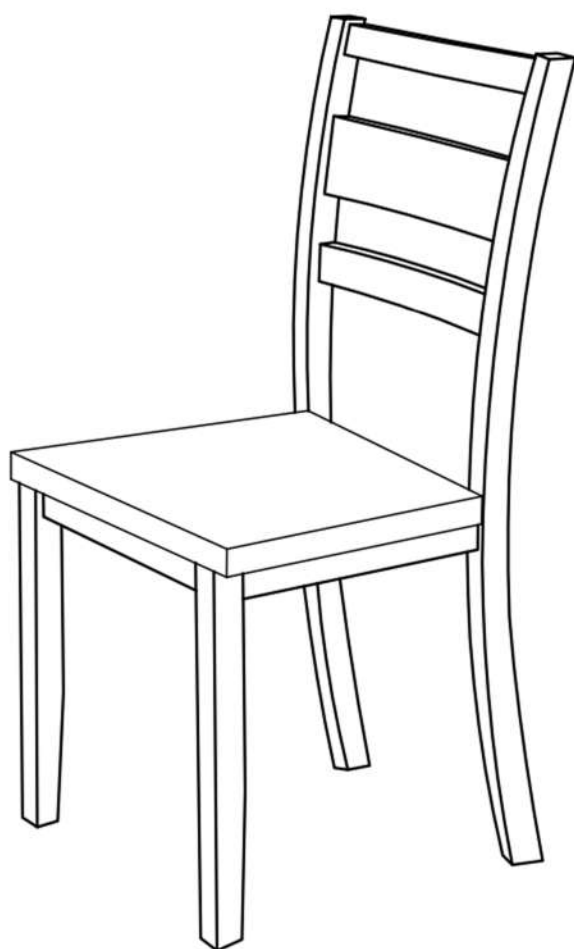

0000415830



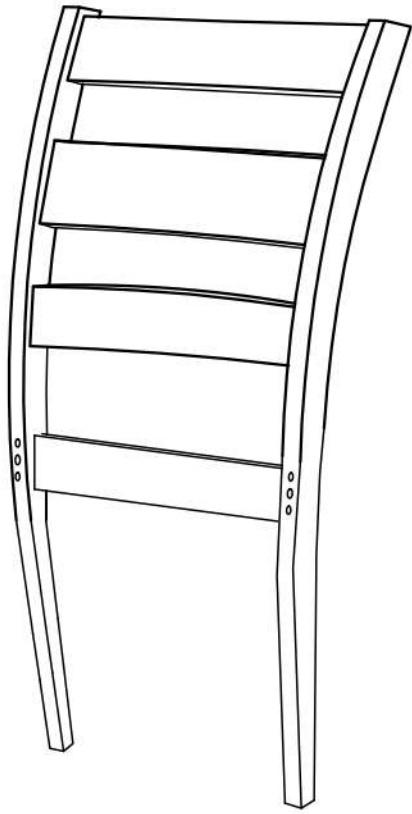

A X1

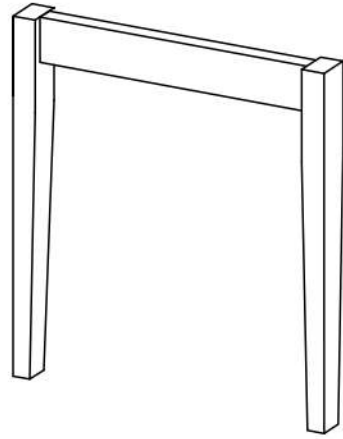

B X1

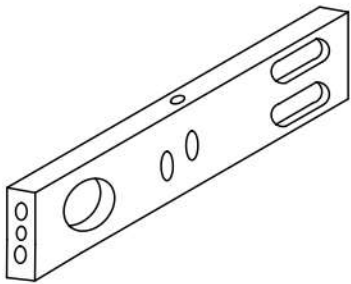

C X2

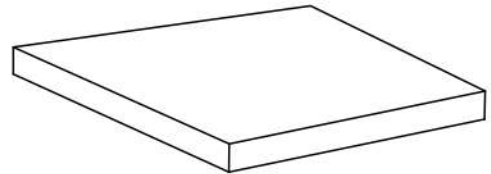

D X1

