

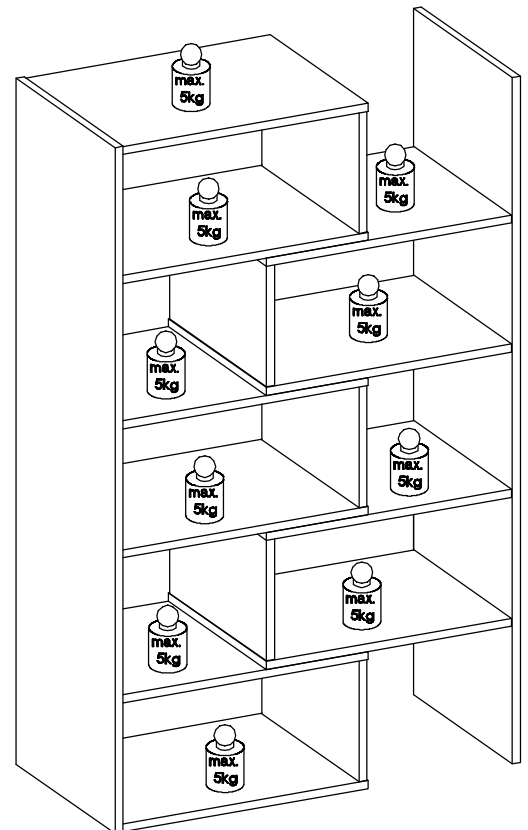

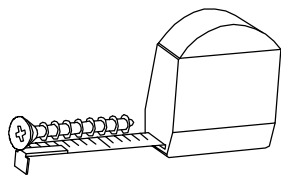

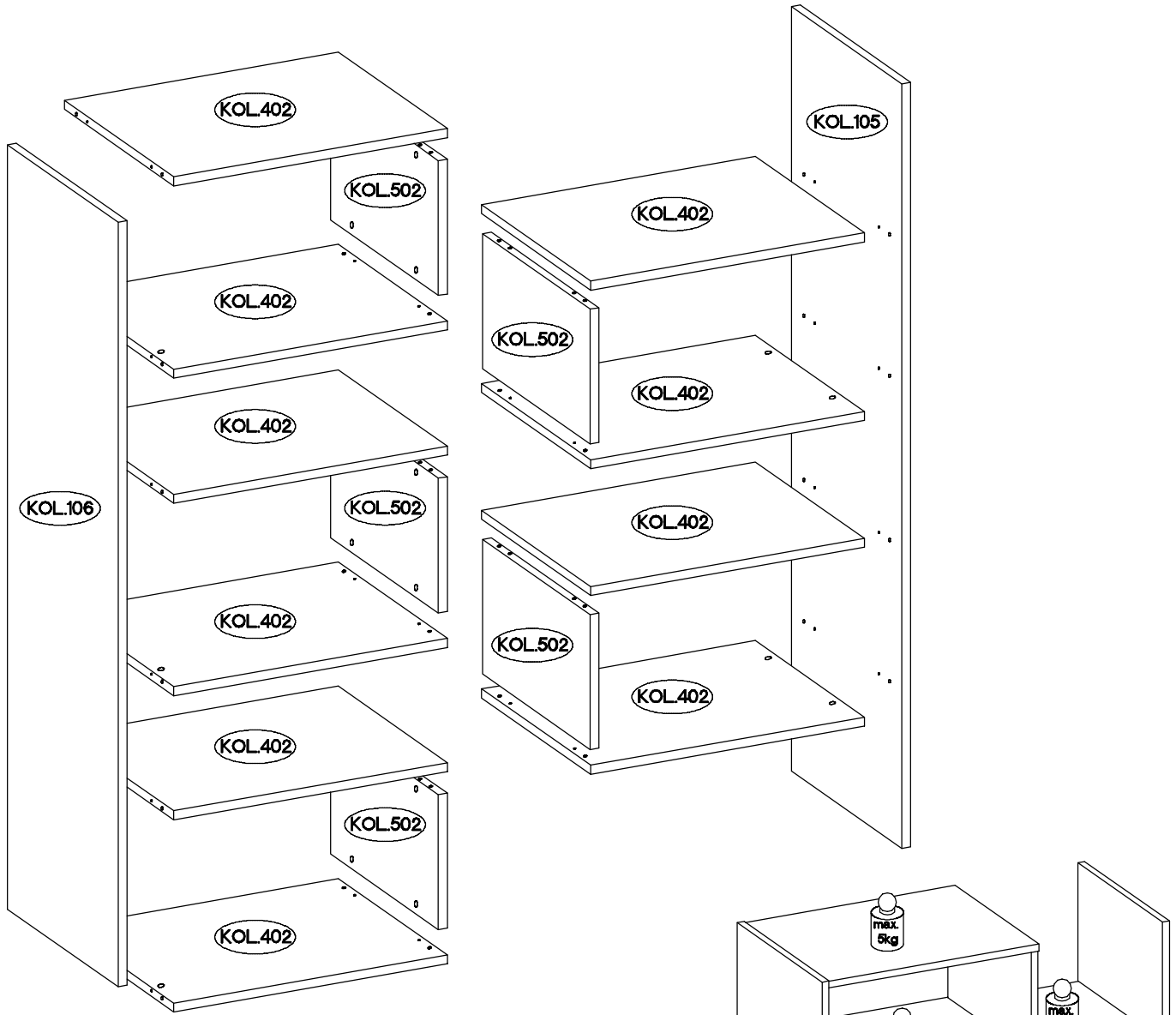

KLOE I

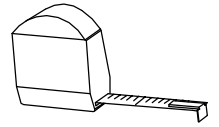
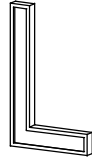
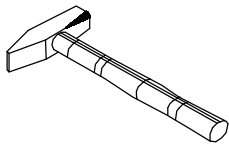
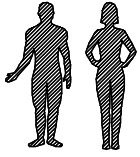

 #8x30mm A 40	 L=20mm D2 40	 #15/12mm C 40	 #15x5mm F4 6	 E 40	 0,05 O11 1
--	---	--	---	--	---

1.

$\varnothing 8 \times 30 \text{ mm}$ A	L=20mm D2
40 $\varnothing 15/12 \text{ mm}$ C	40 0,05 O11
40	1

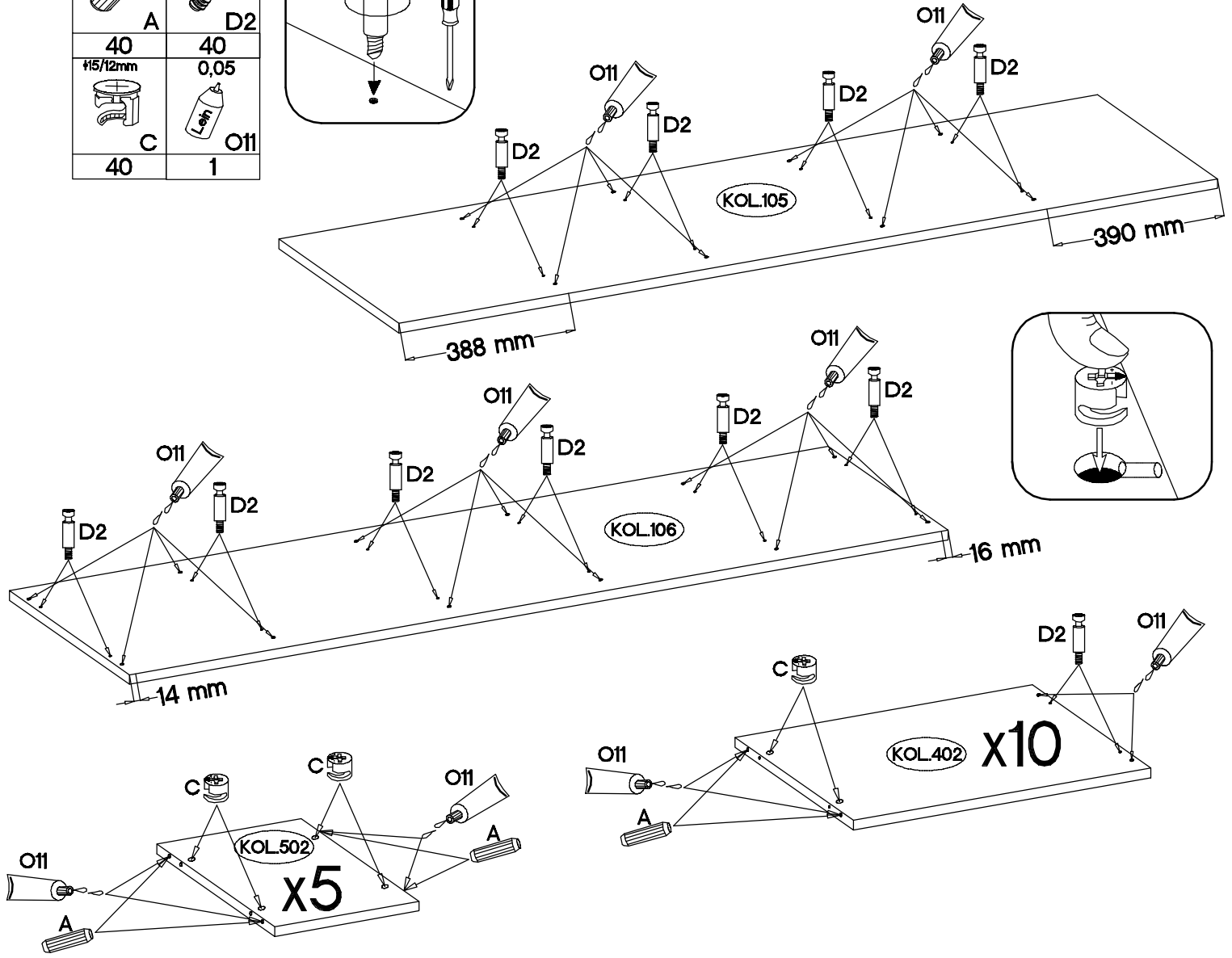
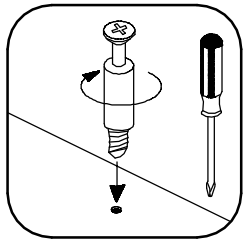

2.

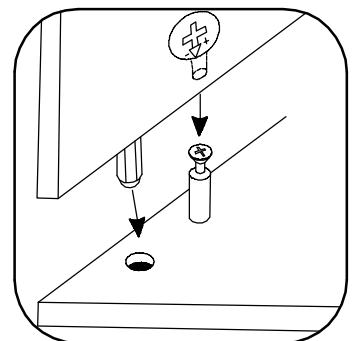
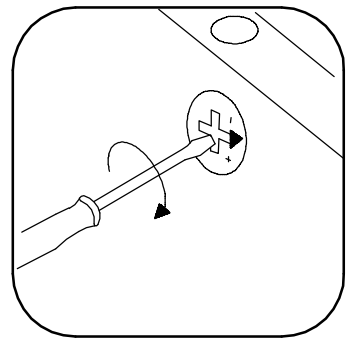
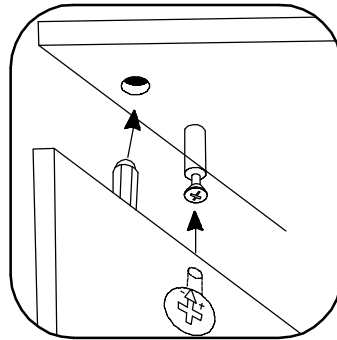
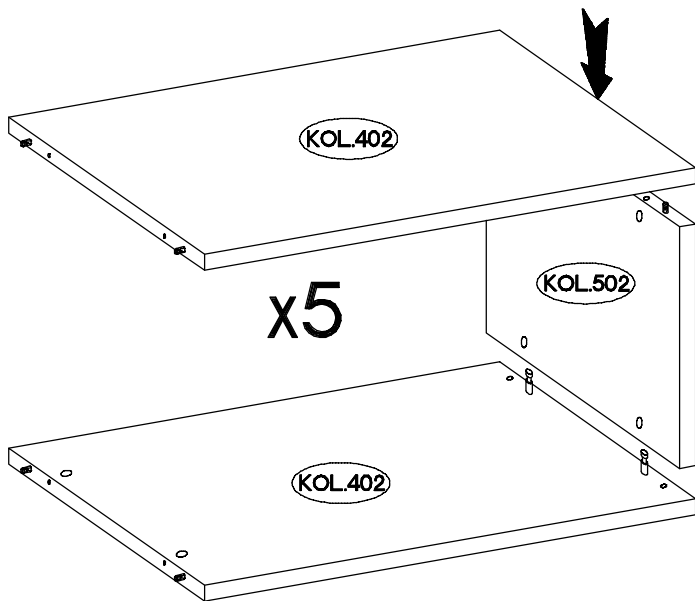

3.

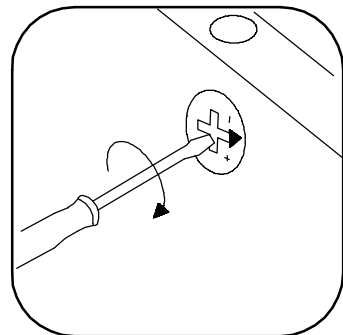
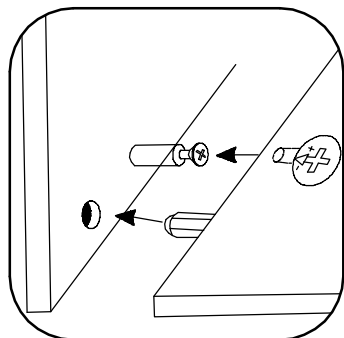
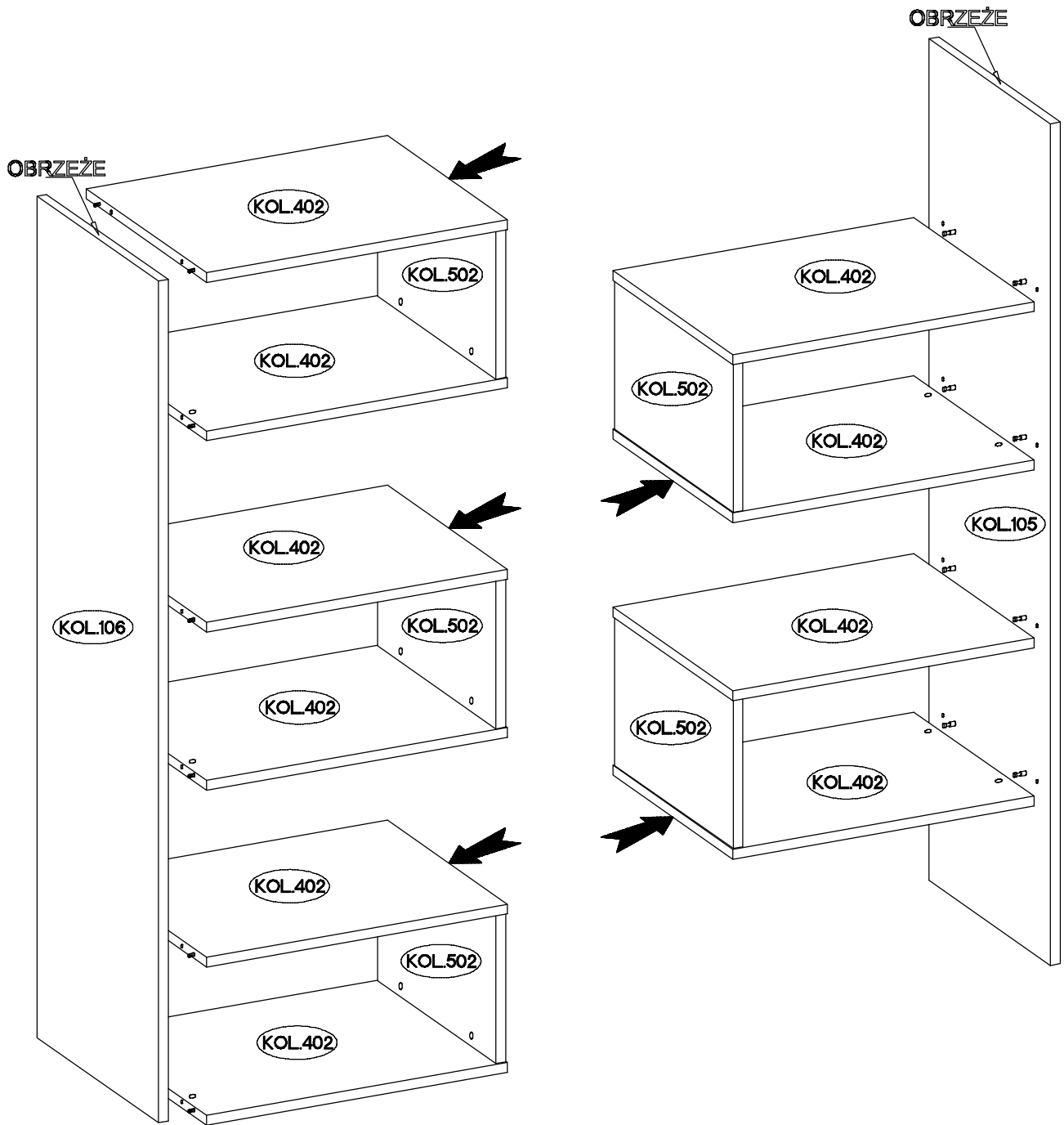

4.

∅15x5mm	
F4	E
6	20

