

PARMAD

Art.-Nr.

408 322
408 323
408 324
408 325
408 326

686
1015
400
[mm]

1/8
VO
20-2025

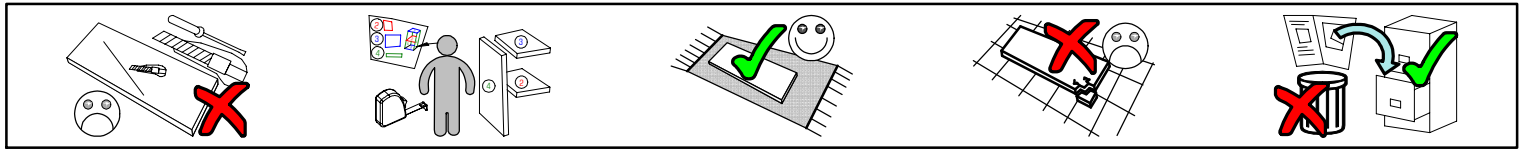
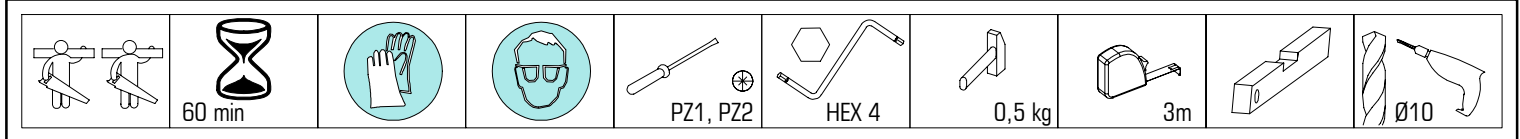

ID	ID			
22175	②	968*382*16	1x	1/1
22176	③	968*382*16	1x	1/1
22177	④	652*58*16	3x	1/1
22178	⑤	686*383*16	1x	1/1
22179	⑥	686*400*16	1x	1/1
22180	⑦	680*222*16	4x	1/1
19025	⑧	350*120*16	4x	1/1
22181	⑨	594*120*16	4x	1/1
19027	⑩	350*120*16	4x	1/1
22182	⑪	356*624*3	4x	1/1
22183	⑫	996*339*3	2x	1/1

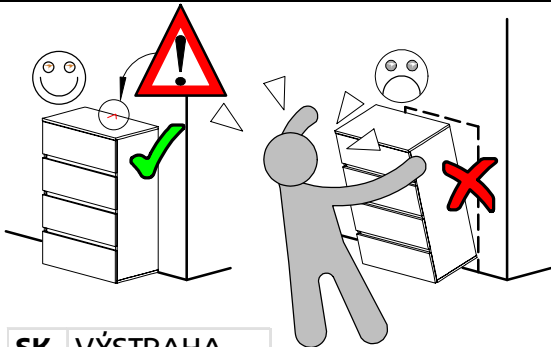
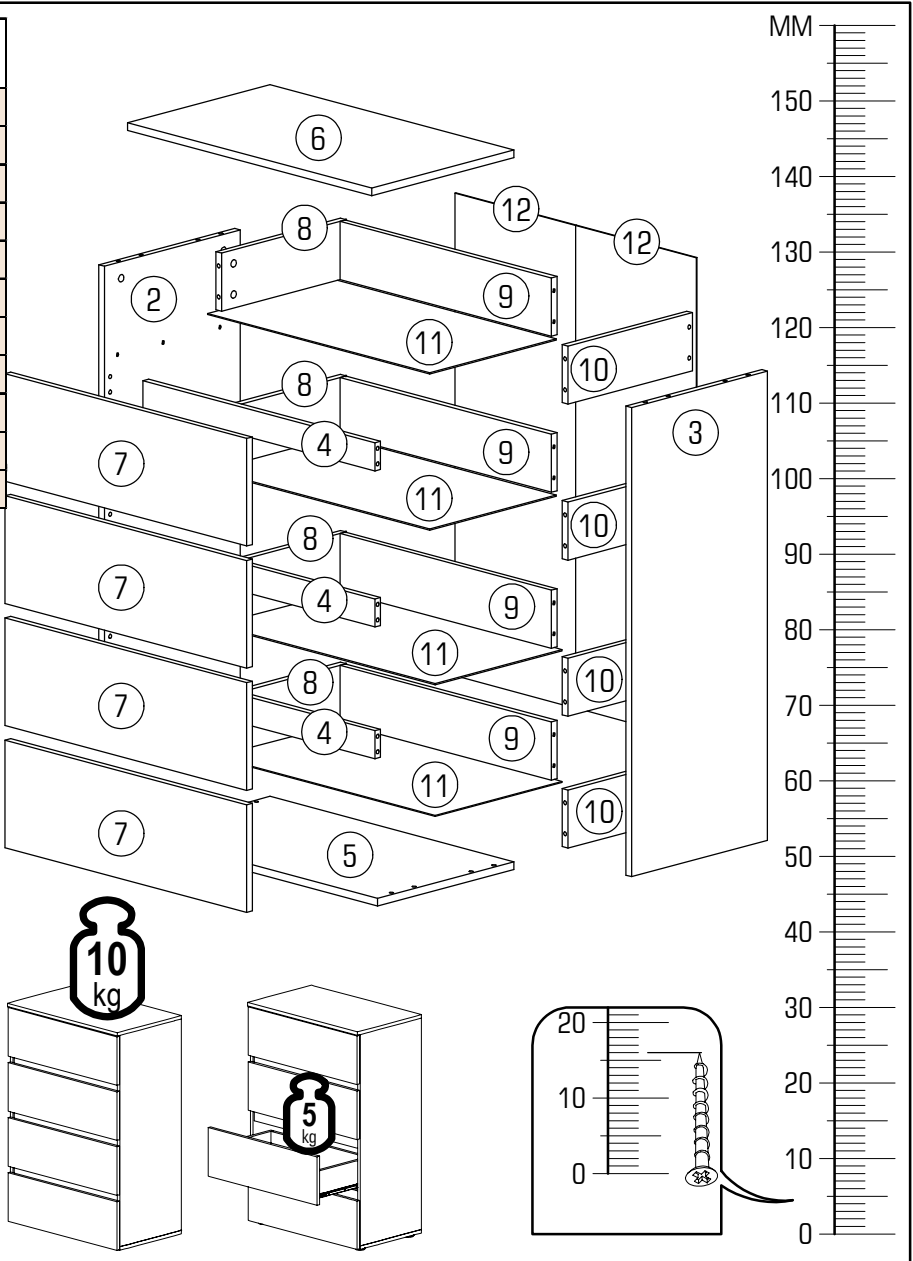



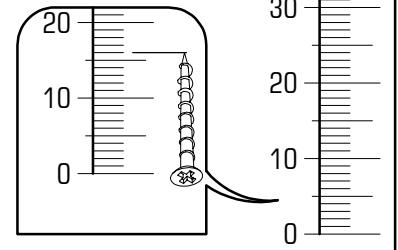
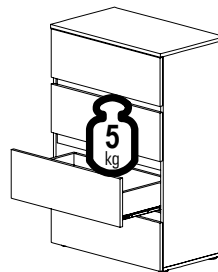
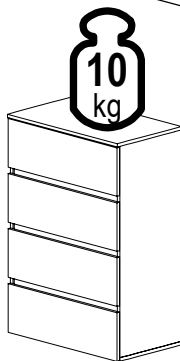

SK	VÝSTRAHA
CZ	VAROVÁNÍ
HR	UPOZORENIE
DE	WARNUNG
HU	FIGYELEM
PL	OSTRZEŻENIE
RO	AVERTIZARE
EN	WARNING
SI	OPOZORILO

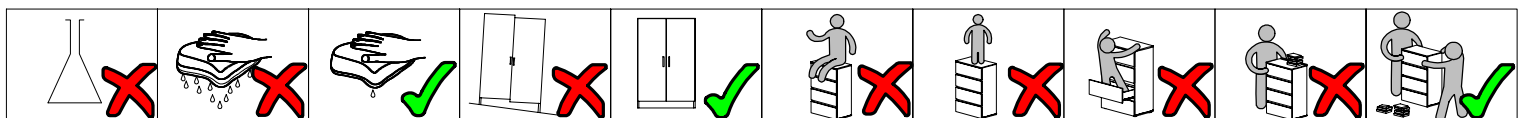

	27000.00		22300.00		22800.01		22244.01		31103.00		22705.00		30080.00		22243.00		22256.00		
A	20x	B	20x	C	1x	D	22x	E	1x	F	24x	G	4x	H	36x	J	1x		
21102.00		70013.01		70021.01			33006.01		33006.01	8402.03		31104.00		22250.00		24101.00			
K	50x	L	20x	M	20x	N	20x	P	4x	Q	4x	R	4x	S	2x	T	4x	U	1x

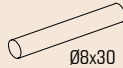
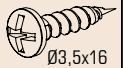
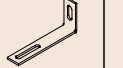

2/8 PARMAD

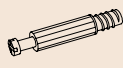
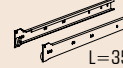
							
A 20x	D 2x	E 1x	F 24x	H 8x	L 4x	M 4x	P 4x

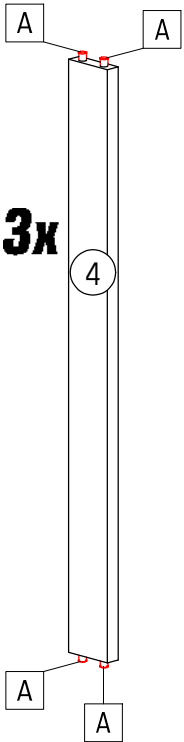
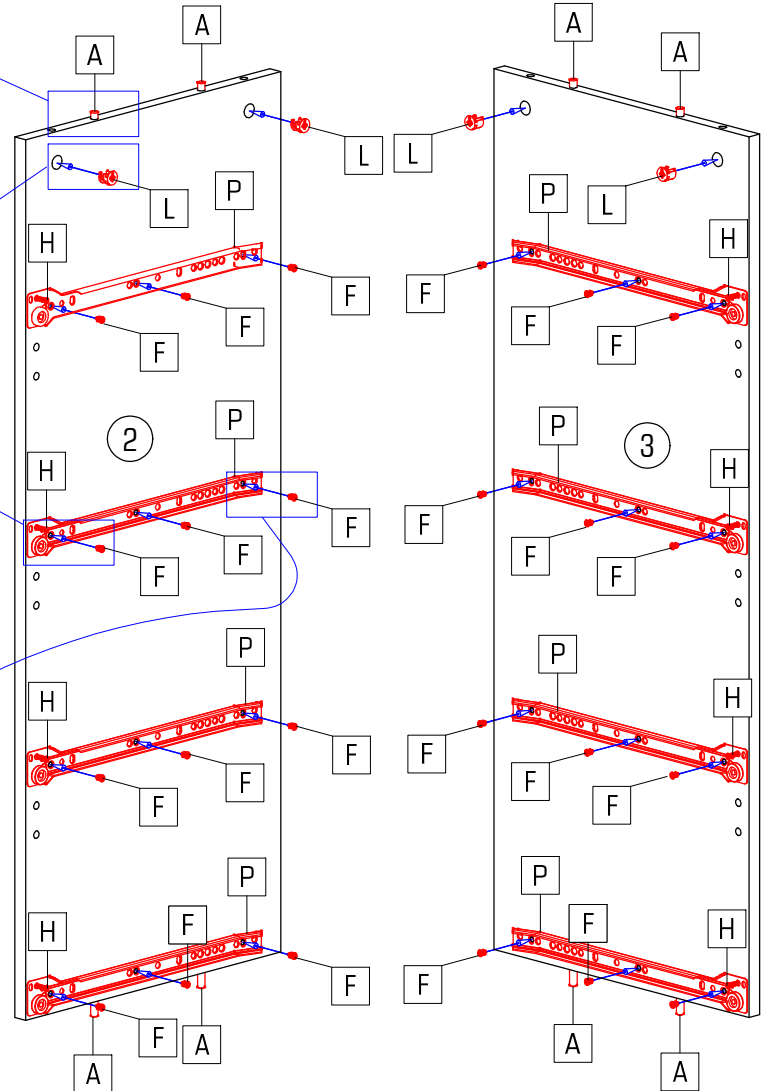
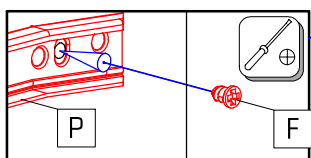
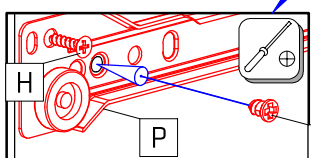
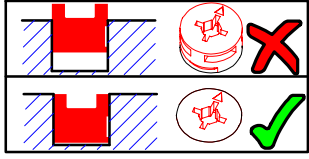
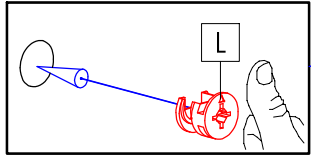
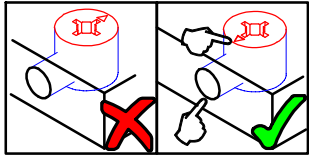
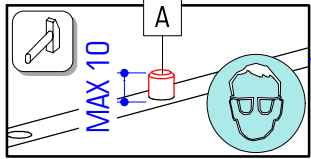
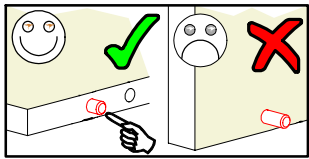

3x

4

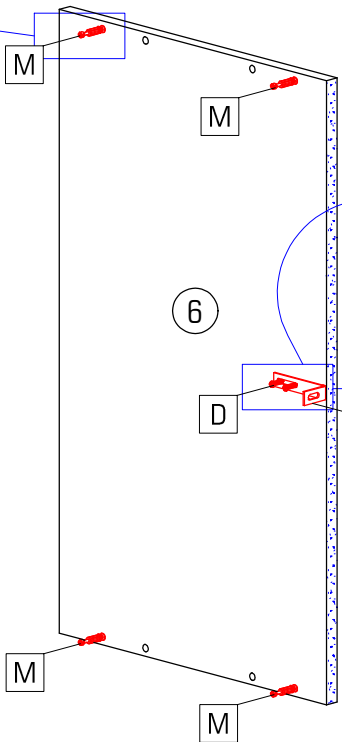
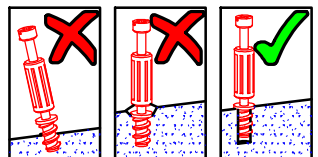
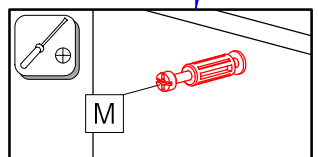

6

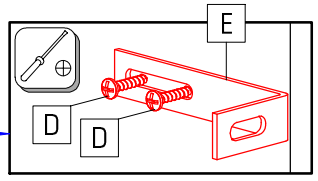

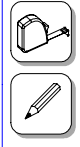

1/2



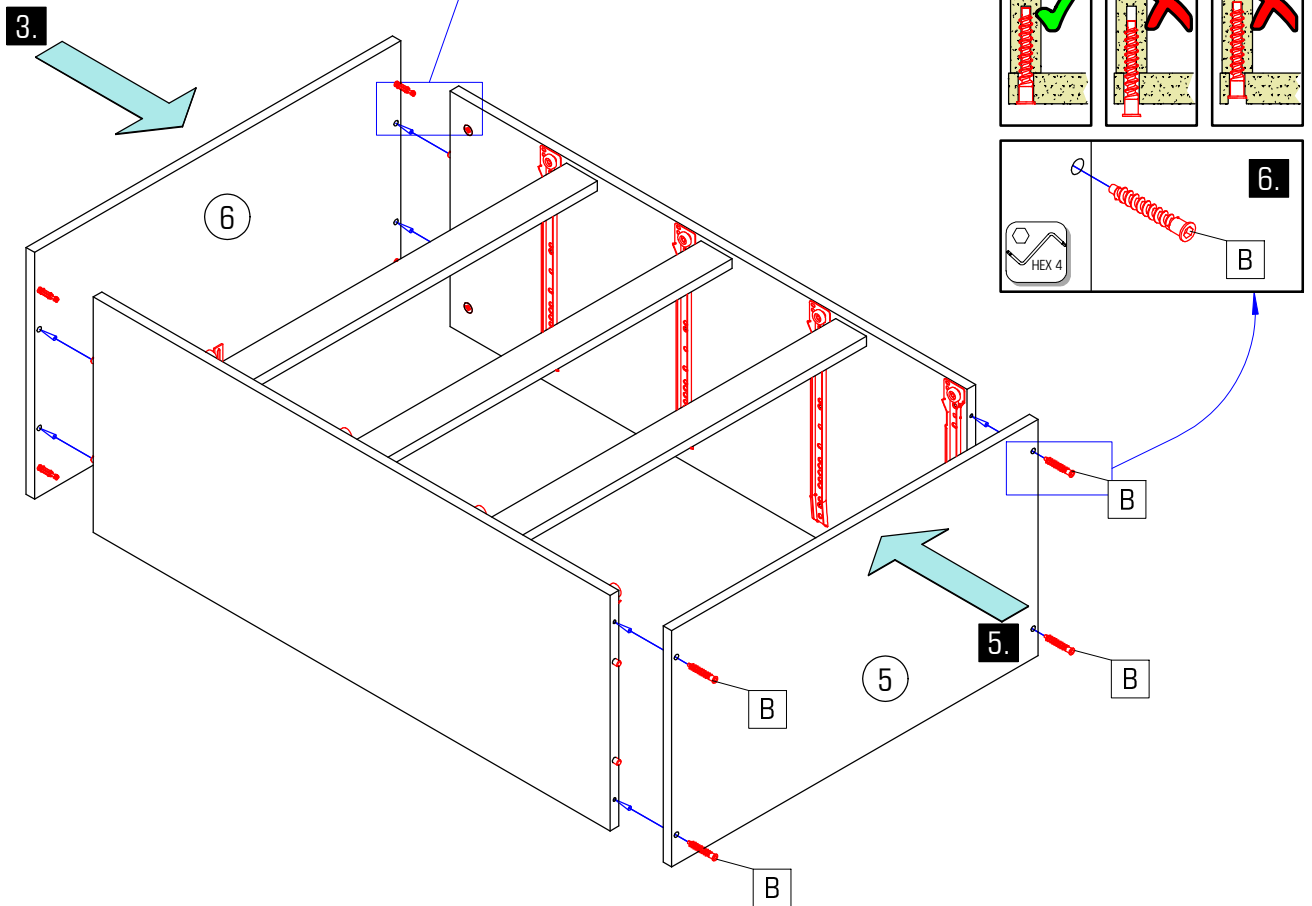
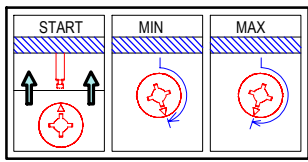
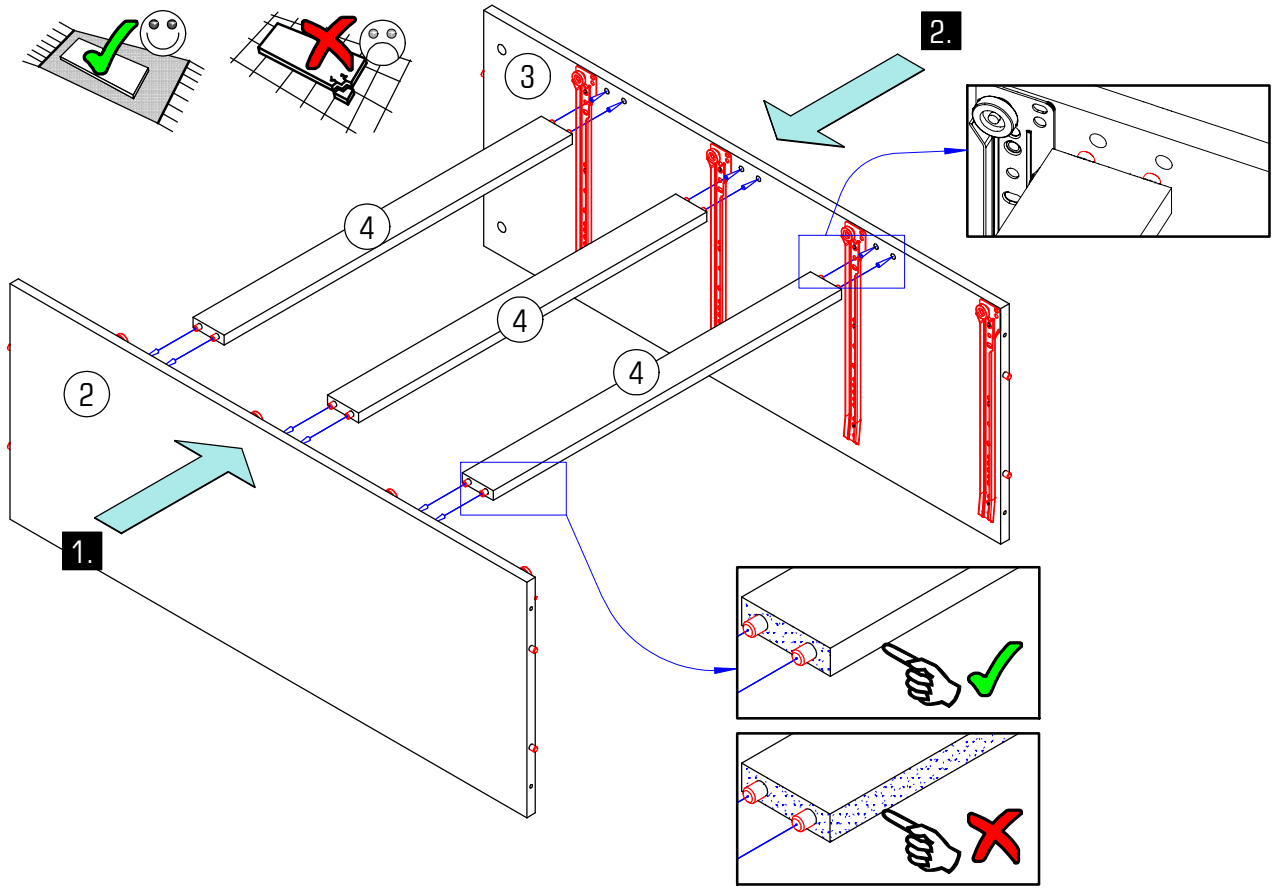
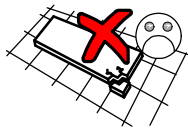
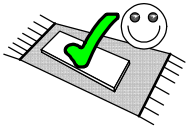



	Ø7x50
B	4x



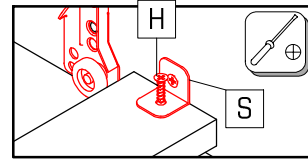
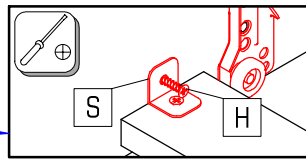
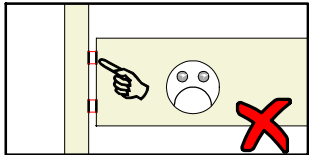
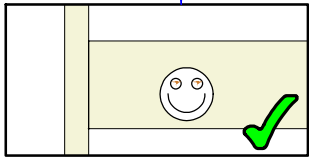
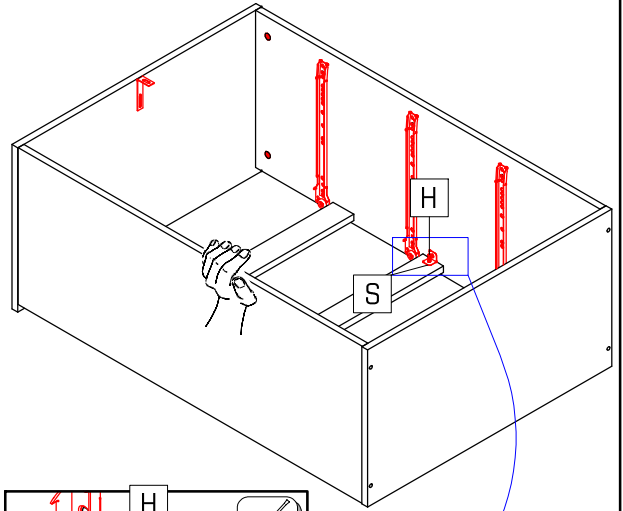
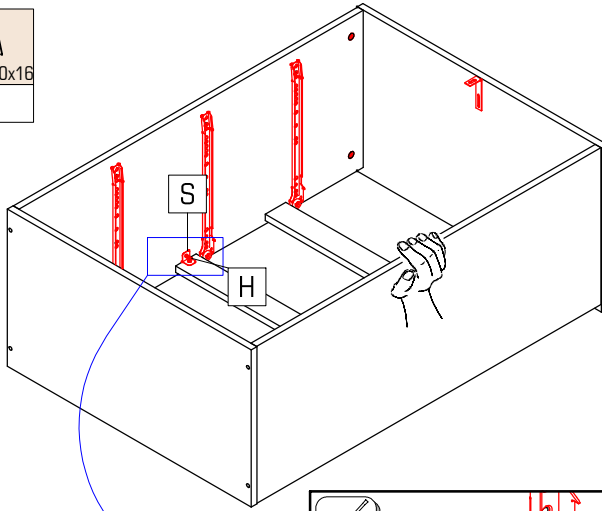
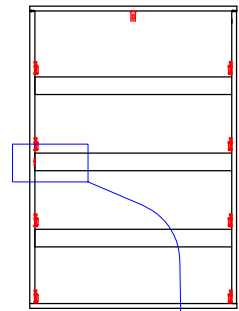

4/8 PARMAD

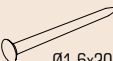
	$\varnothing 3,5 \times 15$		$20 \times 20 \times 16$
H	4x	S	2x

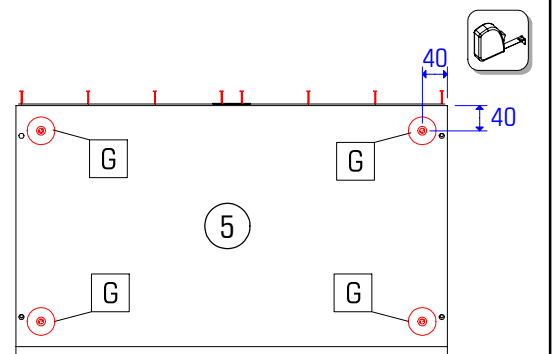
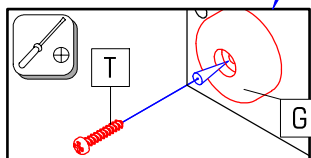
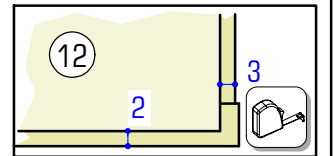
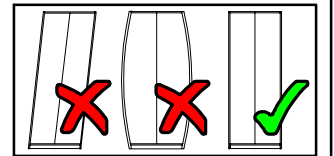
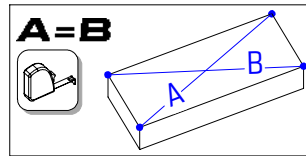
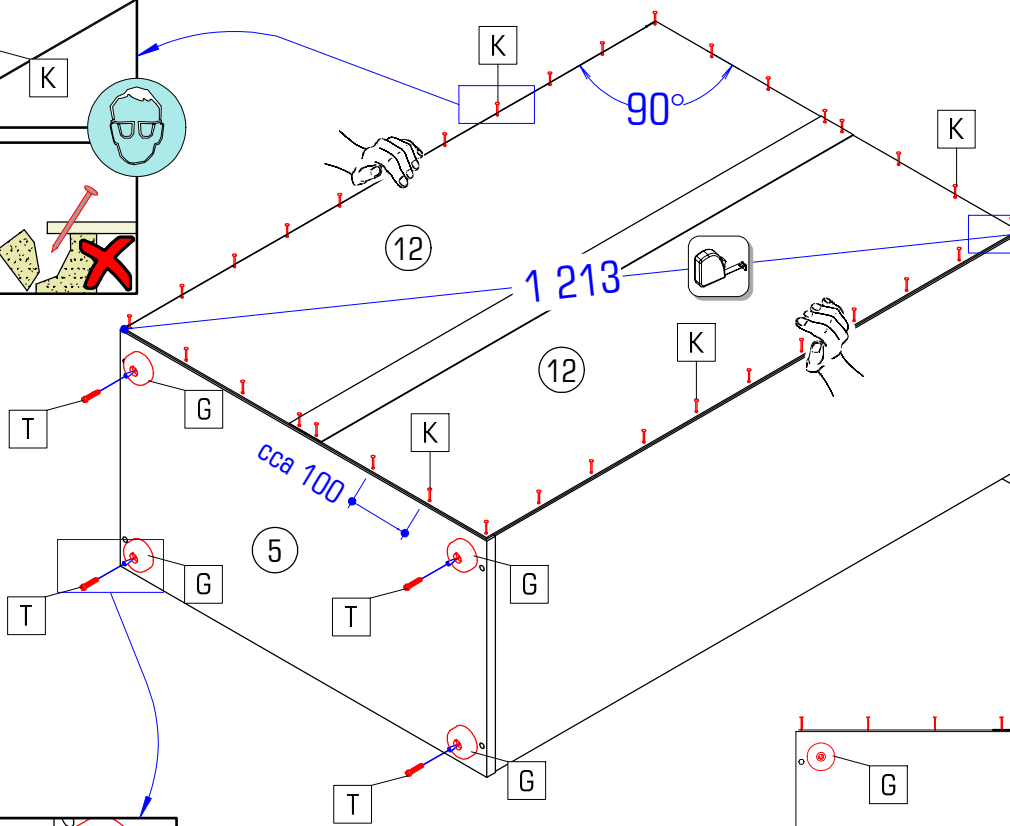
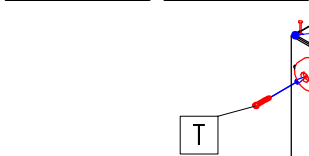
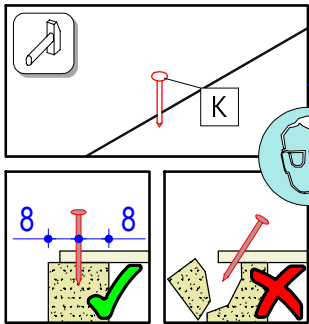

	$\varnothing 44 \times 15$		$\varnothing 1,6 \times 20$		$\varnothing 4,0 \times 25$
G	4x	K	50x	T	4x

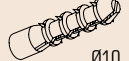

	
Ø5,0x70	Ø10
J 1x	U 1x

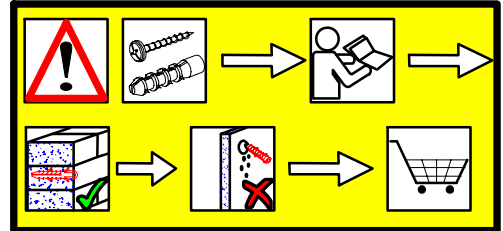
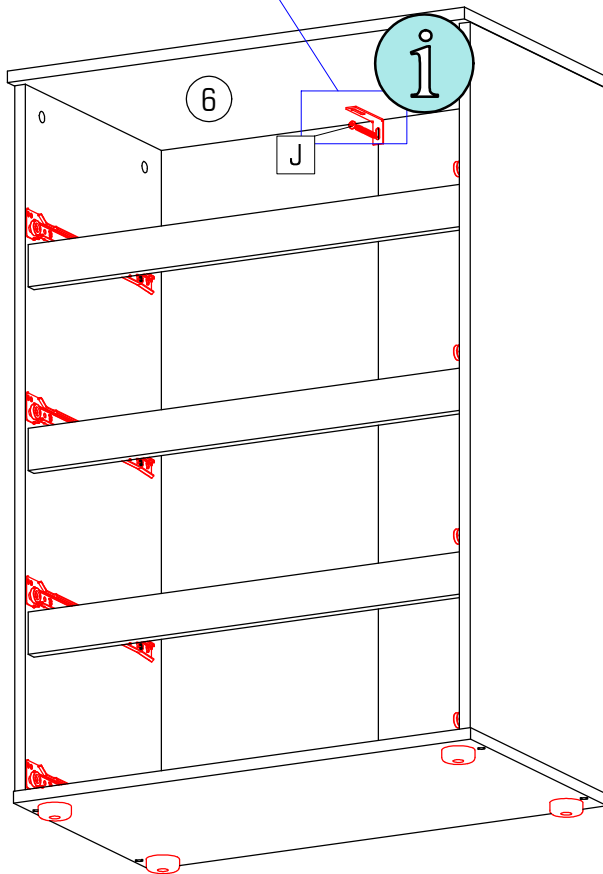
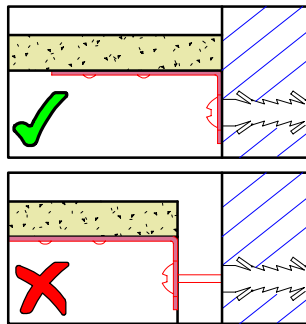
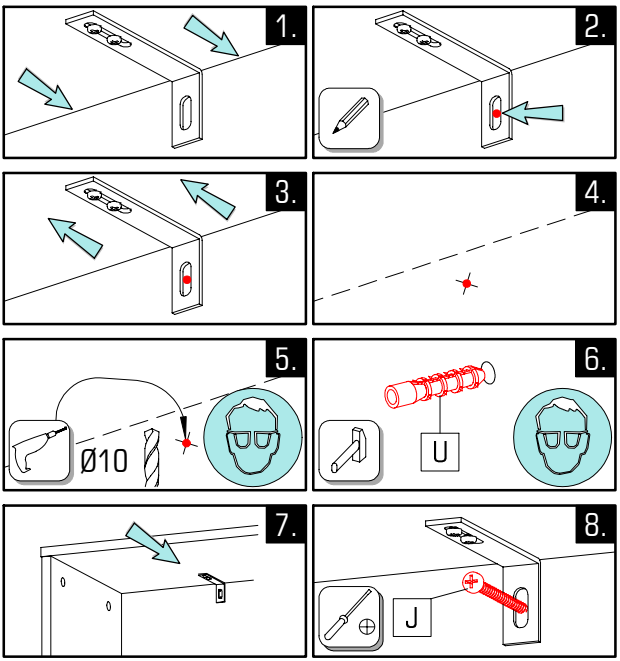

PL Uwaga! Ścianę należy sprawdzić przed montażem. Dołączone uniwersalne kołki rozporowe są odpowiednie tylko do stosowania w mocnych murach, takich jak beton lub cegła. Nie rób z pomocą kołków rozporowych murówanych, takich jak pustak, lekka kostka, powierzchnie takie jak płyty gipsowo-kartonowe lub inne systemy ram. Jeśli dotyczy, muszą to być określone kołki rozporowe być użytych! Są one dostępne w specjalistycznym sklepie niezgodność, producent / sprzedawca lub importer nie ponoszą odpowiedzialności.

DE Achtung! Die Wandbeschaffenheit ist vor der Montage unbedingt zu prüfen. Die beigelegten Universaldübel sind ausschließlich nur zur Verwendung für festes Mauerwerk wie Beton/Ziegel. Die Mauerdübel dürfen nicht bei Mauerwerk wie Hohlraumziegel, Leichtbausteinen, Gipskartonplatte oder anderer Rahmenbauweise verwendet werden. Bei diesen Mauerwerken sind gegebenenfalls Spezialdübel zu verwenden! Diese sind in einem Fachgeschäft erhältlich. Bei Nichteinhaltung wird seitens Produzenten/Händler und Importeur keine Haftung übernommen.

EN Caution! The wall must be examined before assembly. The included universal wall plugs are only suitable for using in firm masonry such as concrete block or brick. Do not use the wall plugs masonry such as hollow brick, lightweight block, surfaces such as gypsum plasterboard or other framing systems. If applicable, particular wall plugs must be used! These are available at a specialised store (hardware store). In case of non-compliance, the manufacturer/retailer or importer do not assume liability.

RO Prudență! Zidul trebuie examinat înainte de asamblare. Prizele de perete sunt adecvate numai pentru utilizarea în zidărie fermă, cum ar fi betonul bloc sau cărămidă. Nu folosiți zidăria zidurilor de perete, cum ar fi cărămida goală, blocul ușor, suprafețe cum ar fi gips-carton sau altă încădrare sisteme. Dacă este cazul, trebuie folosite anumite prize de perete! Acestea sunt disponibile la un magazin specializat (magazin de hardware). În caz de nerespectare, producătorul / vânzătorul cu amănuntul sau importatorul nu își asumă răspunderea.

HR Pažnja! Prije montaže obavezno provjerite svojstvo zida. Priložene univerzalne tiplje namijenjene su isključivo za masivne zidove od betona/opeke. Tiplje za masivne zidove ne smiju se koristiti za zidove kao npr. šupljina opeka laki sastavni elementi, gips-kartonske ploče ili drugi modularni načini gradnje. Za te zidove potrebne su eventualno posebne tiplje! Iste su dostupne u specijaliziranim trgovinama građevinskim materijalom. U slučaju nepridržavanja prethodno navedenih napomena, proizvođač/trgovac i uvoznik ne preuzimaju odgovornost!

CZ Upozornění! Před montáží je nutné zkontrolovat stav stěny. Příložené univerzální hmoždinky jsou určeny pouze k použití pro pevné zdivo jako beton/cihly. Hmoždinky do zdi se nesmí používat u dutinová cihla, zdíva jako porovité stavební kámen, sádrokartonová deska nebo jiný měkký materiál. U těchto zdív jsou nutné použít speciální hmoždinky! Jsou k dostání v speciálních prodejnách se stavebním materiálem. Při nedodržení těchto pokynů výrobce/prodejce a dovozce neručí za způsobené škody.

SI Pozor! Pred montažo preverite stanje stene. Priloženi univerzalni mozniki so izključno samo za uporabo na čvrstem zidovju, kot sta beton in opeka. Stenski mozniki se ne smejo uporabljati pri zidovju kot so votlina opeke, zidaki za lahko gradnjo, mavčne plošče ali druge okvirne gradnje. Pri teh zidovjih morate v danih primerih uporabljati posebne moznike. Ti so na voljo v specializiranih trgovinah (trgovinah z gradbenim materialom) Pri upoštevanju se s strani proizvajalca/trgovca in uvoznika ne prevzame jamstvo.

HU Vigyázat! Szerelés előtt a falfelületet feltétlenül vizsgálja meg. A mellékelt univerzális tiplje kizárólag stabil falazathoz használható mint például beton/tégla. A fali tiplje nem használható könnyű építőkövekhez, üreg tégla, gipszkarton lapokhoz vagy más fávázás építményekhez. Ezekhez a falfelületekhez csak speciális tiplik használhatóak, melyek szaküzletekben (barkácsruházakban) beszerezhetőek. Fentiek figyelmen kívül hagyása esetén a gyártó/kereskedő vagy forgalmazó nem vállal felelősséget.

SK Upozornenie! Pevnosť steny sa musí pred montážou bezpodmienečne skontrolovať. Priložené univerzálne hmoždenky používajte jedine pre pevné murivo ako je betón/tehla. Hmoždenky sa nesmú používať v prípade ľahkého stavebného muriva, dutá tehla, Sádrokartonová doska, alebo iných konštrukcií rámu. U týchto stien je nutné použiť špeciálne hmoždenky! Tieto je možné dostať v špeciálnych predajniach so stavebným materiálom. Pri nedodržaní pokynov nepreberajú výrobcovia/predajci a dodávatelia zodpovednosť za vzniknuté škody.

6/8 PARMAD

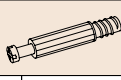
	Ø15x13		M 16x
L	16x	M	16x

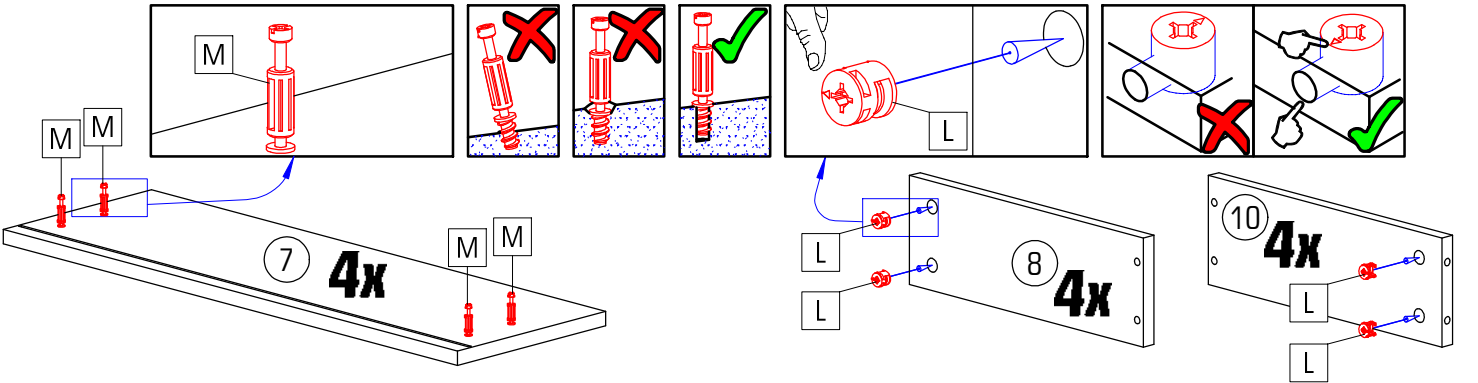

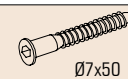
	Ø7x50	B 16x
--	-------	-------

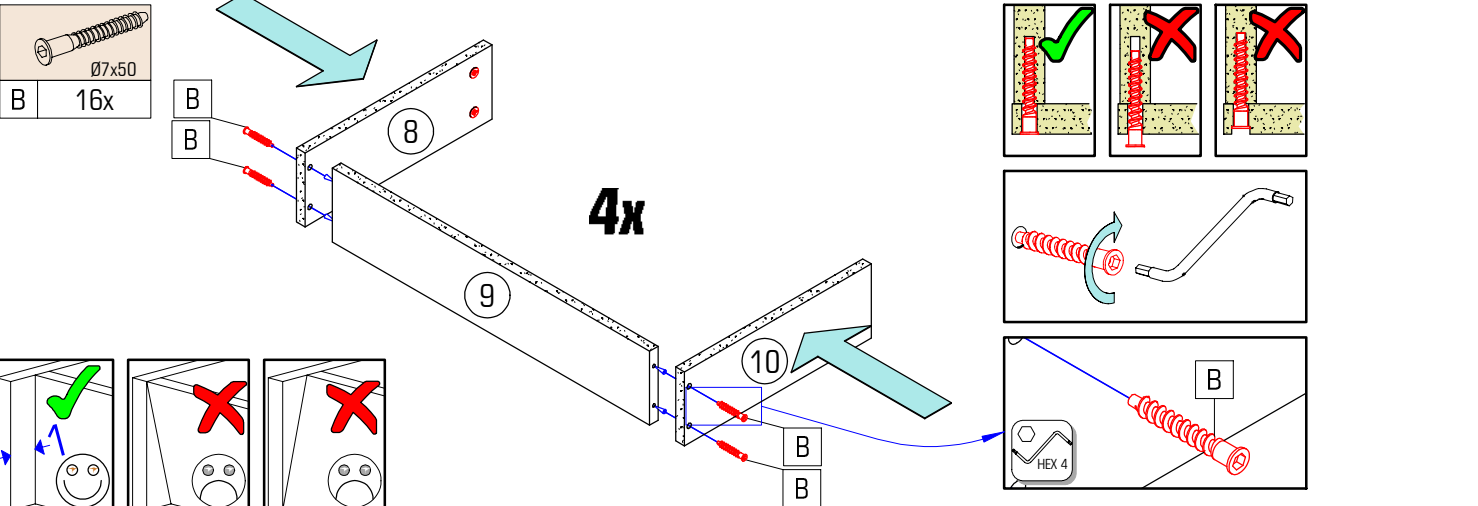

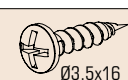
	Ø3.5x16	D 20x
--	---------	-------

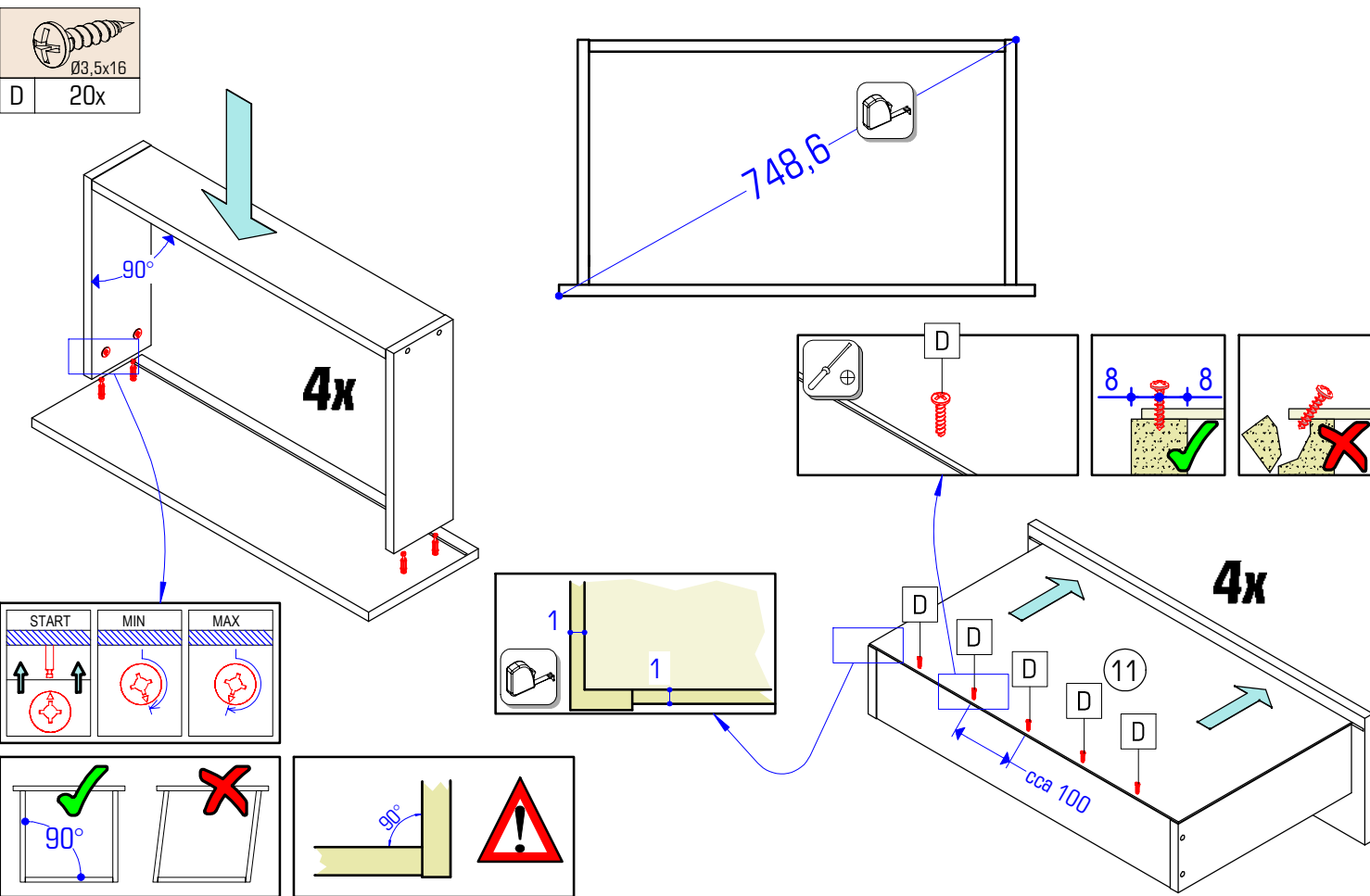

748,6





cca 100

START MIN MAX

90°

90°

!

			
Ø3,5x15		L=350	Ø8
H 24x	N 20x	Q 4x	R 4x

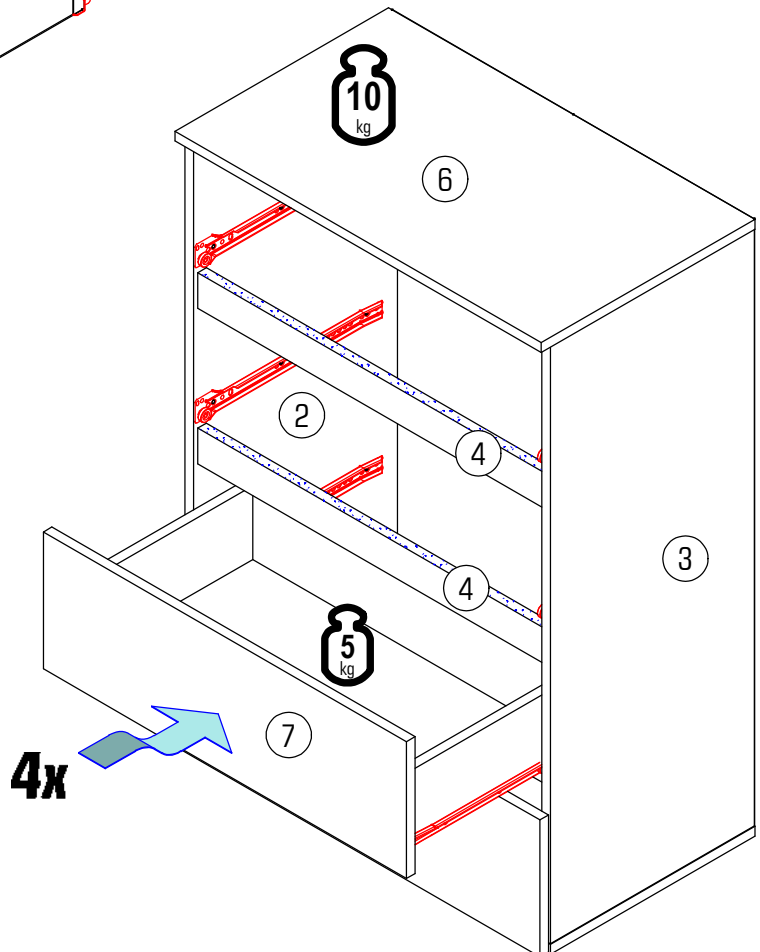
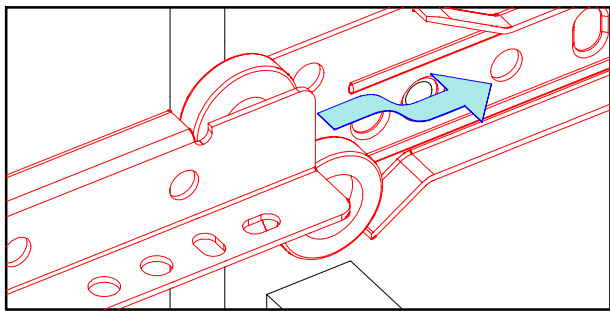
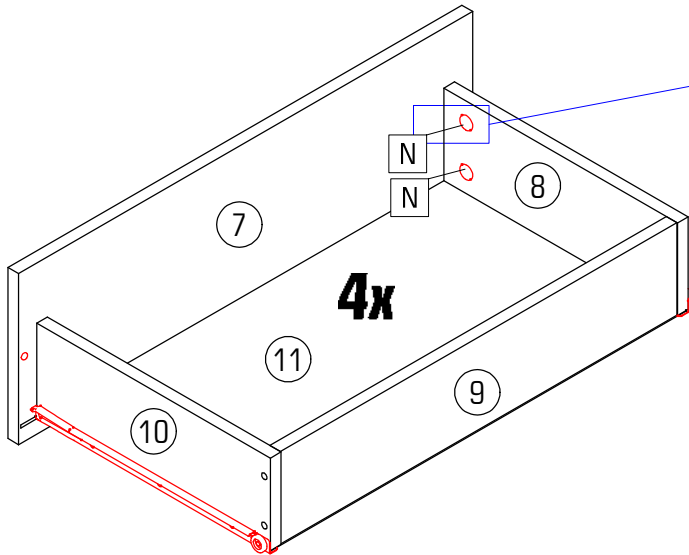
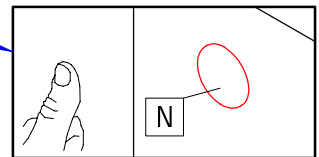
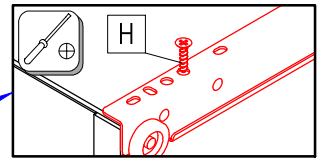
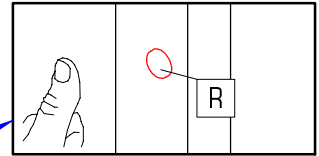
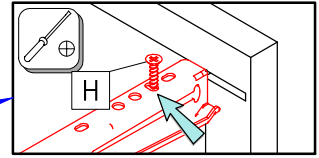
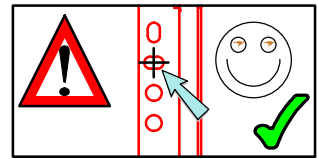
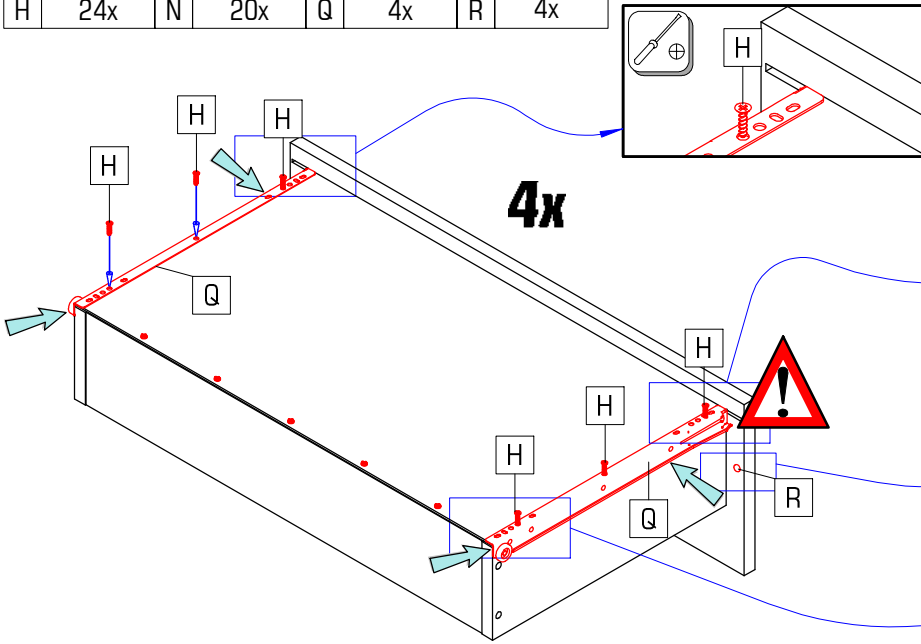

8/8 PARMAD

