

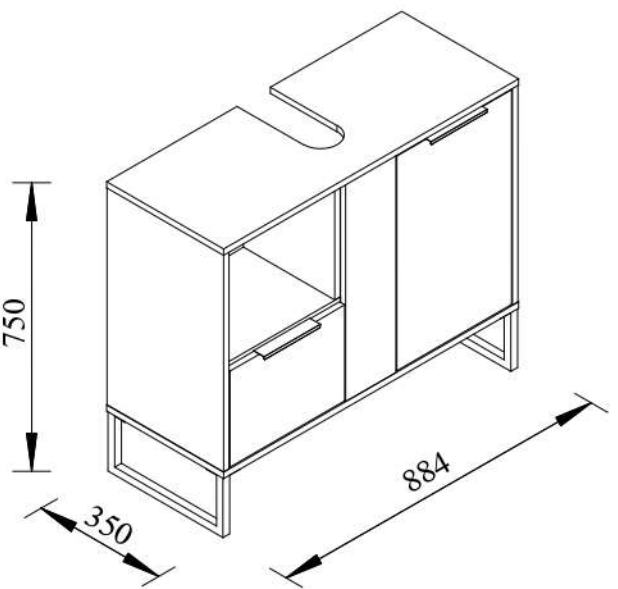

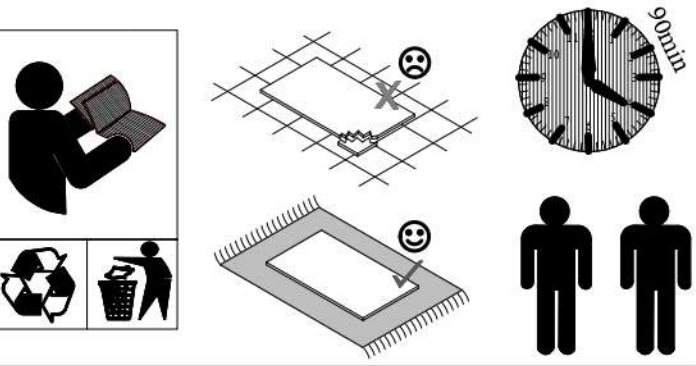

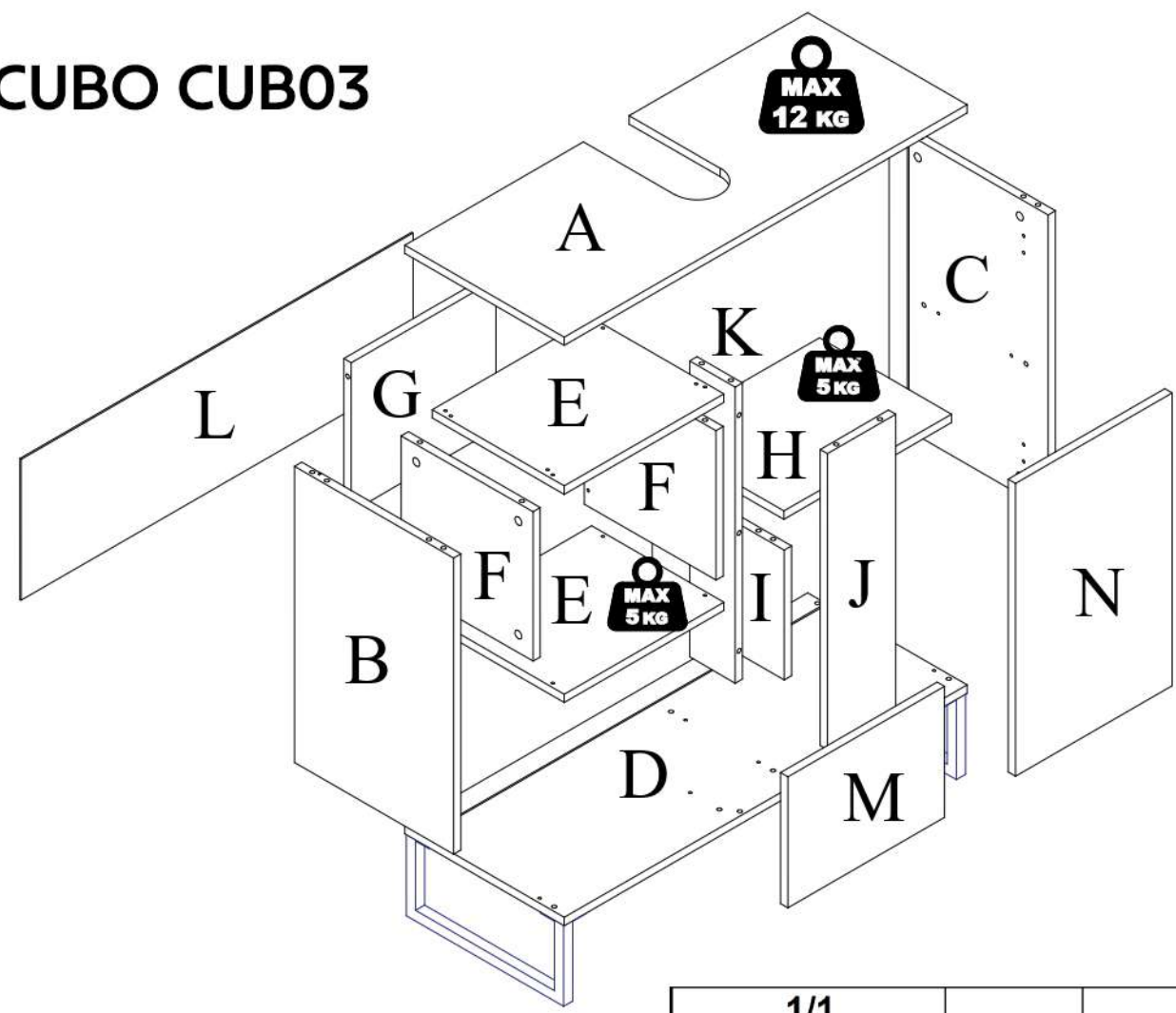

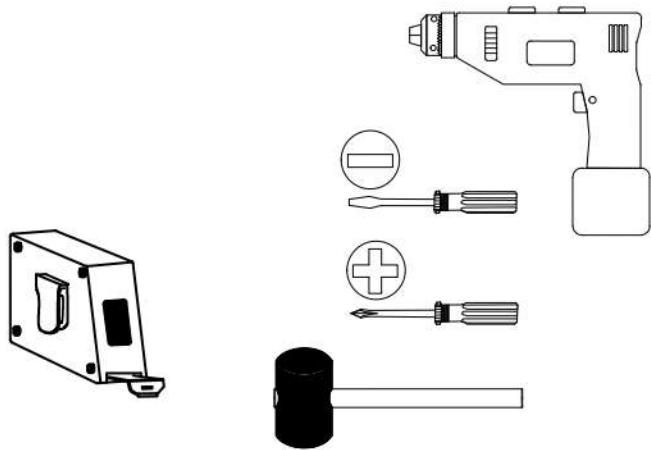



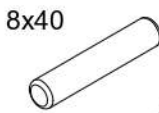

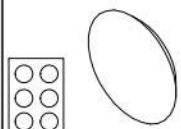
# CUBO CUB03

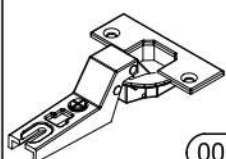
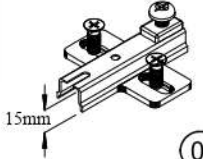

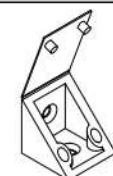
1/1				
A+D	884	x	350	2
E	350	x	287	2
F	284	x	286	2
B+C	563	x	349	2
N	557	x	344	1
G	318	x	284	1
H	368	x	290	1
K	563	x	100	1
M	249	x	344	1
I	290	x	247	1
J	563	x	150	1
L	860	x	268	1

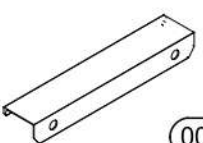
 1x (0013K)	 8x40 18x (0001K)	 Ø15 33x (0018K)
 33x (0019K)	 12x (0054K)	 6x (0004K)
 4x16 13x (0006V)	 4x (0036K)	 4x 15mm (0170K)
 4x16 14x (0001V)	 3x (0131K)	 6x (0101K)
 2x (0024U)	 3x16 4x (0003V)	 1x (0109K)
 5x70 1x (0013V)	 Ø8 1x (0051K)	 4x (0165K)
 2x (0163K)	 1x (0181K)	 2x (0123K)

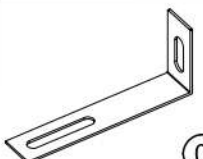
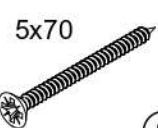
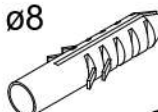
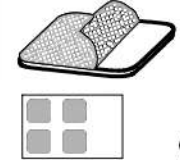
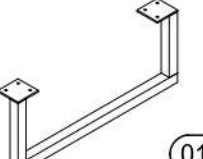
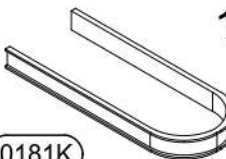
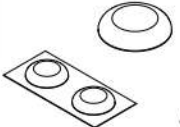
1)

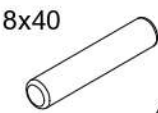
 8x40 18x (0001K)
--

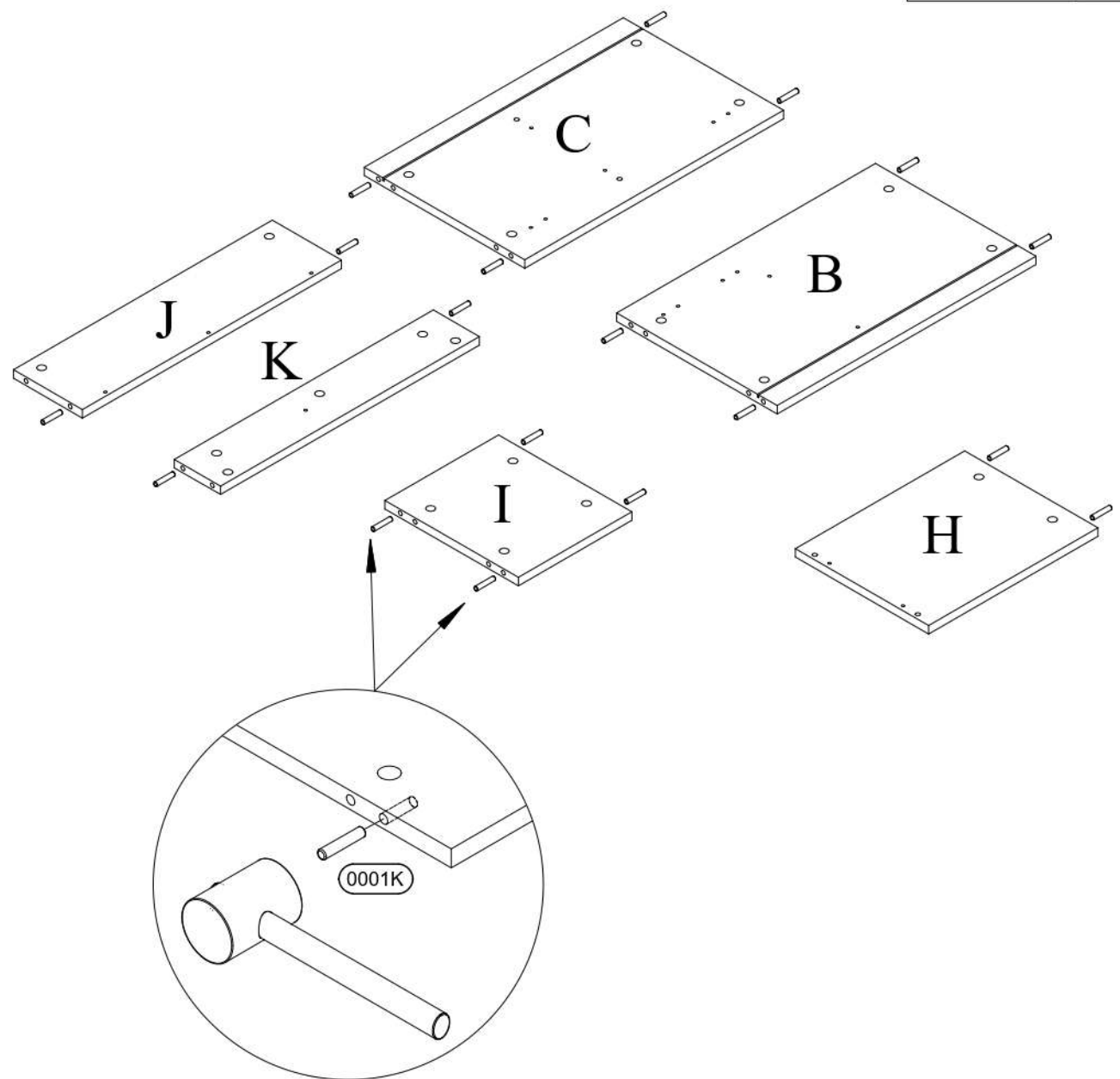

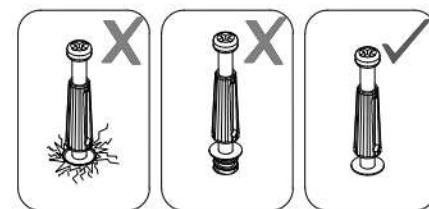
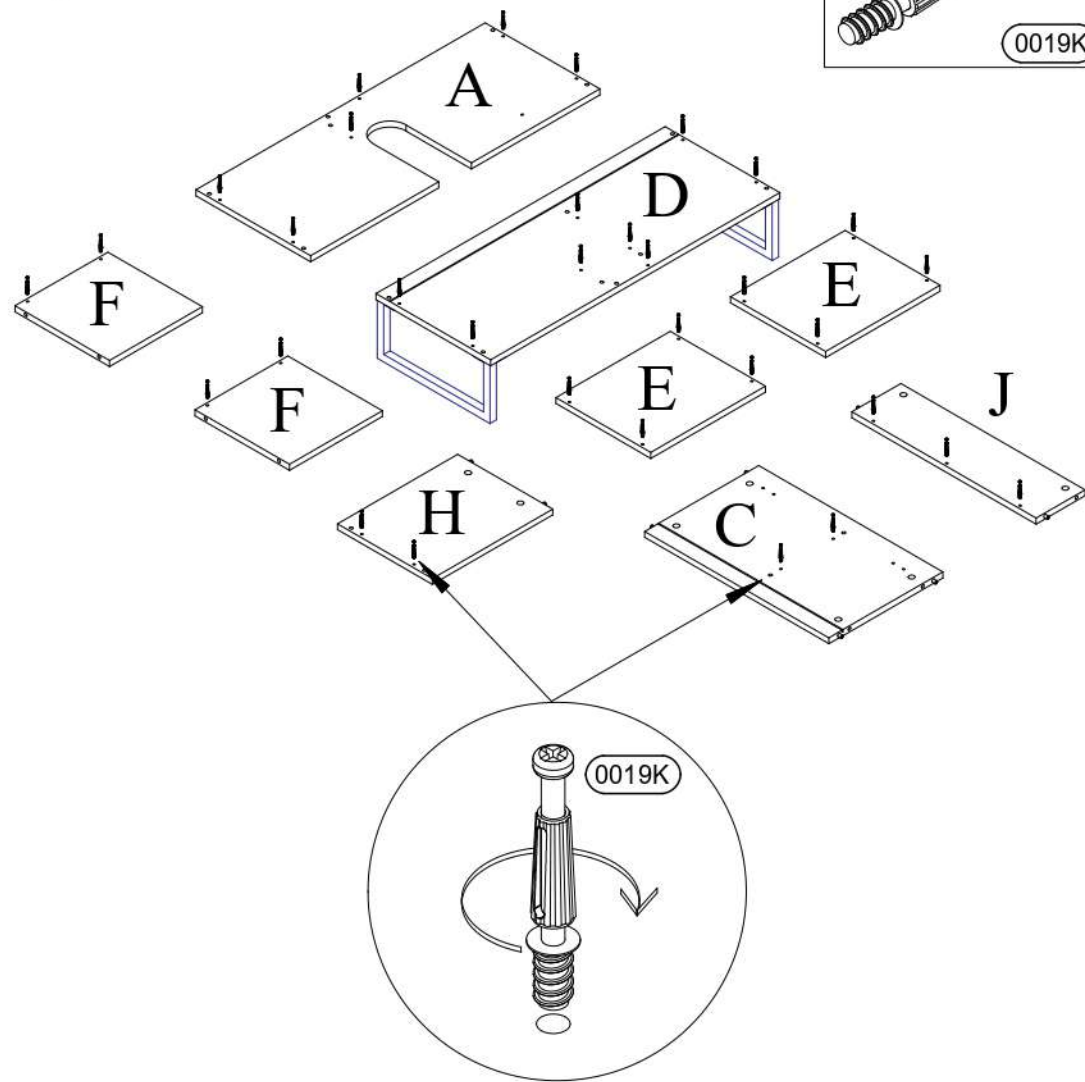
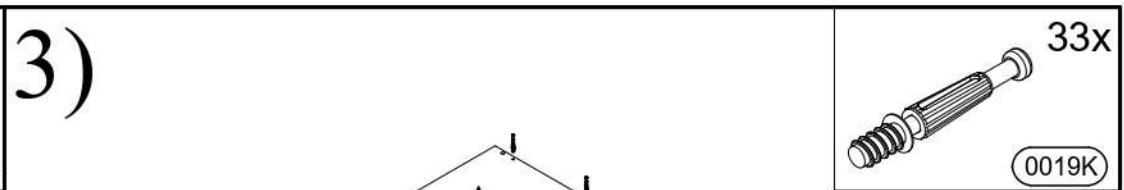
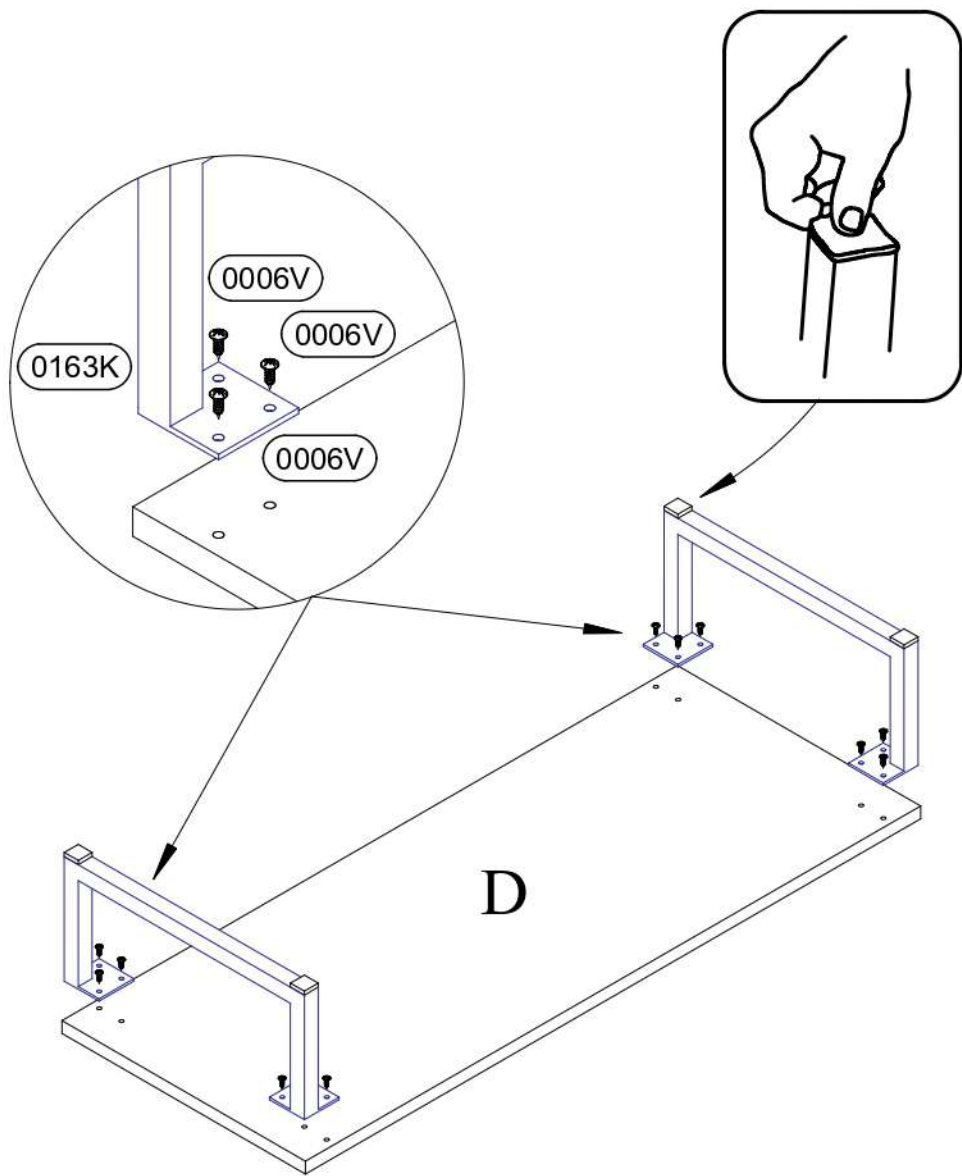
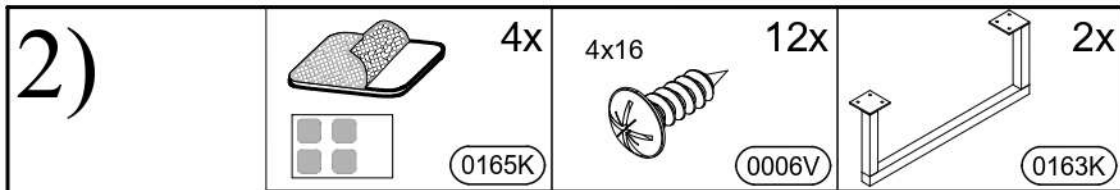

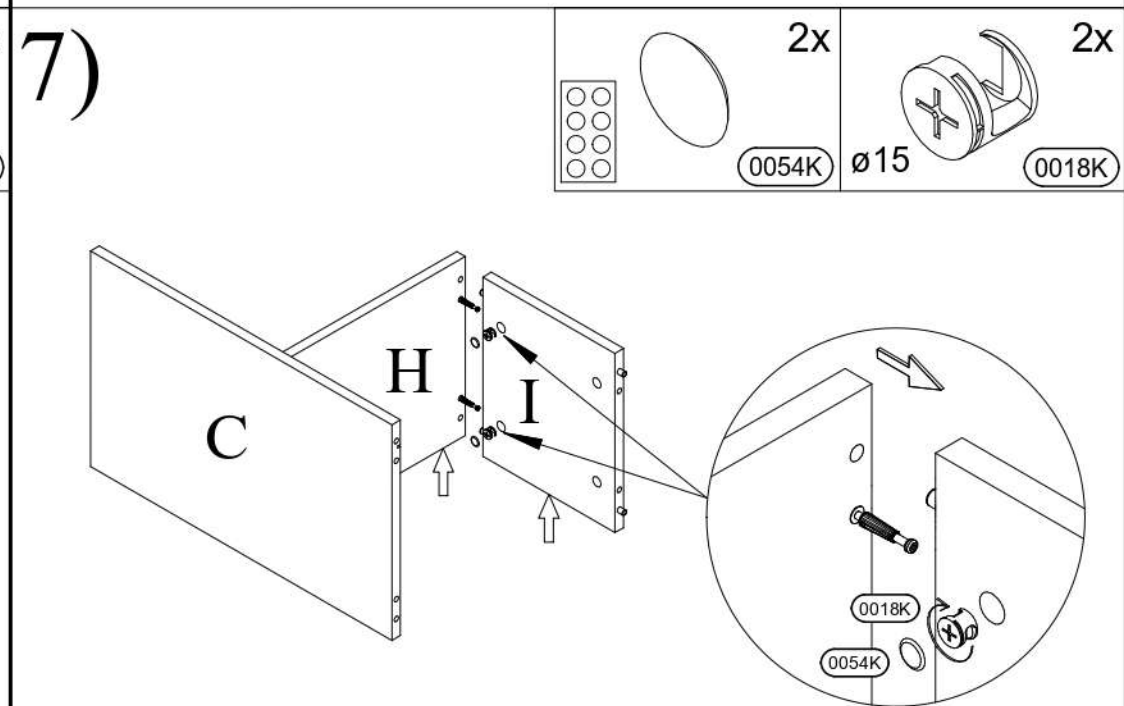
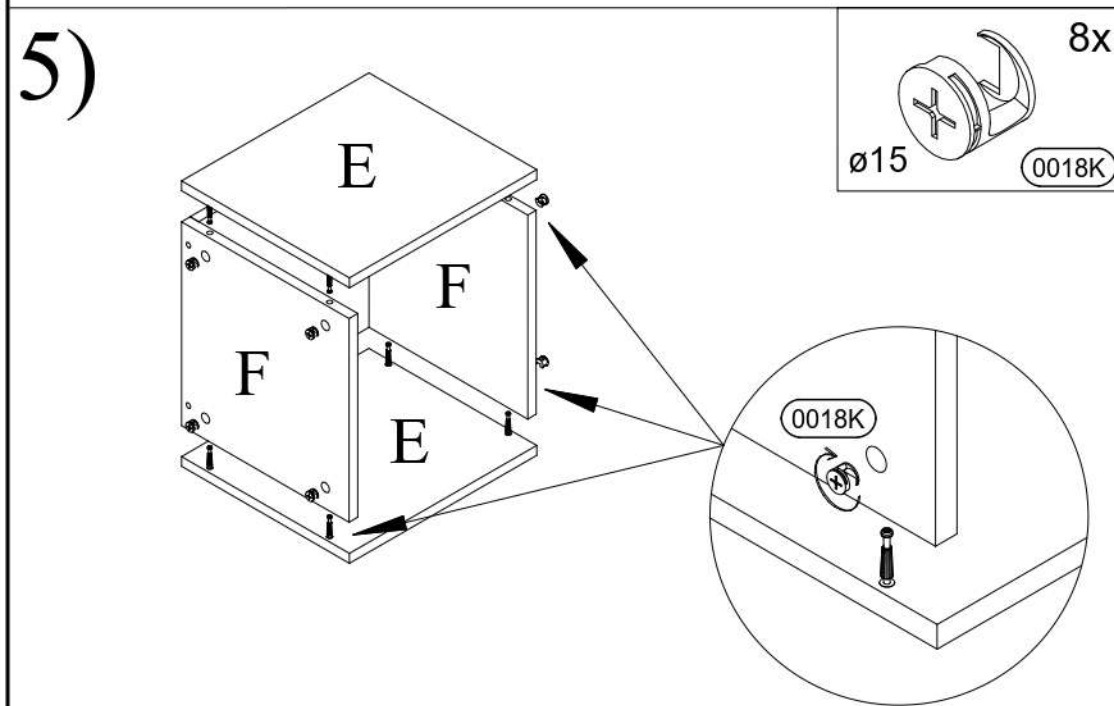
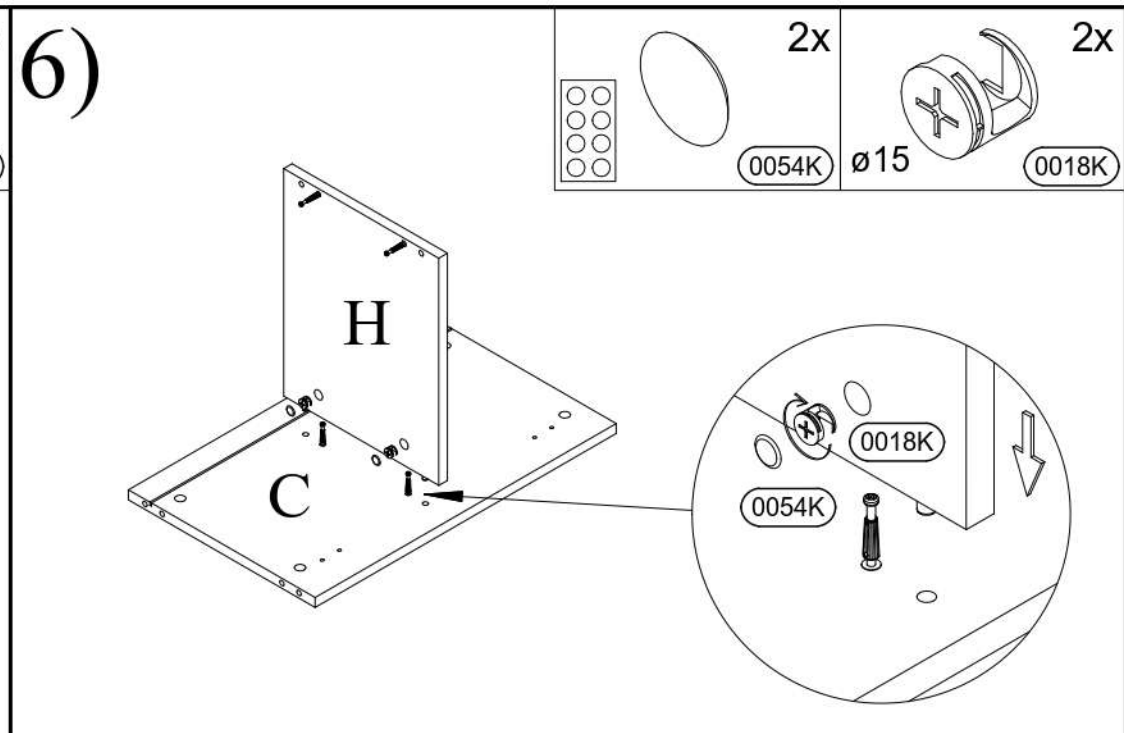
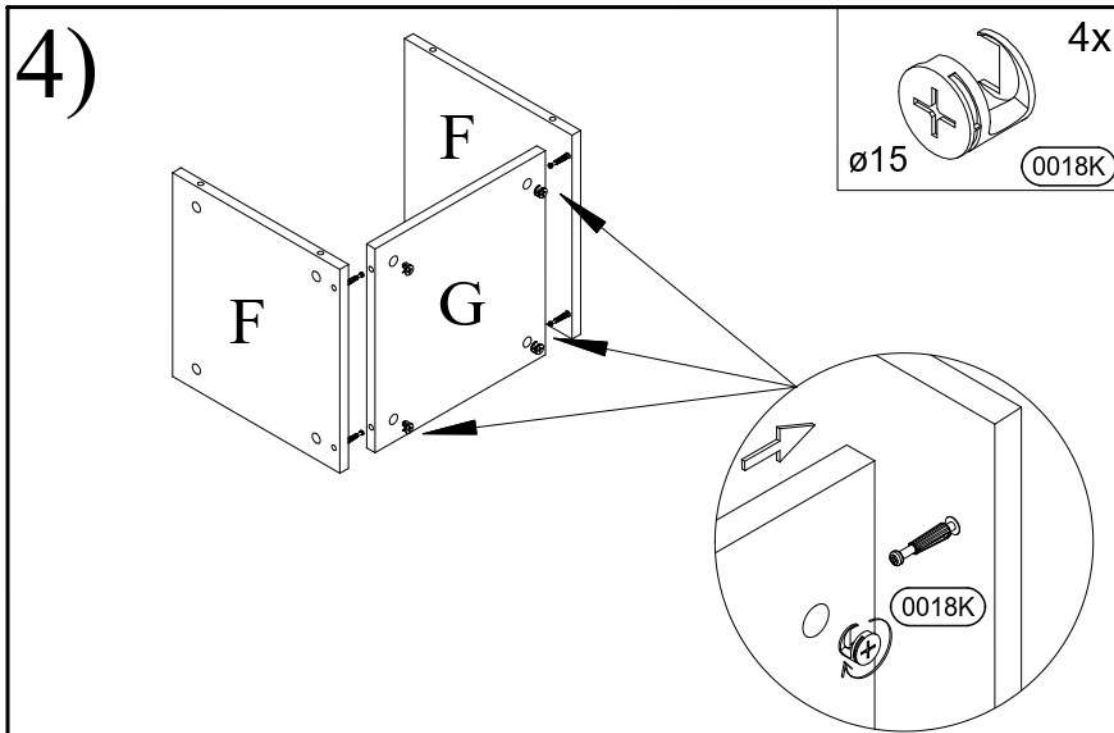

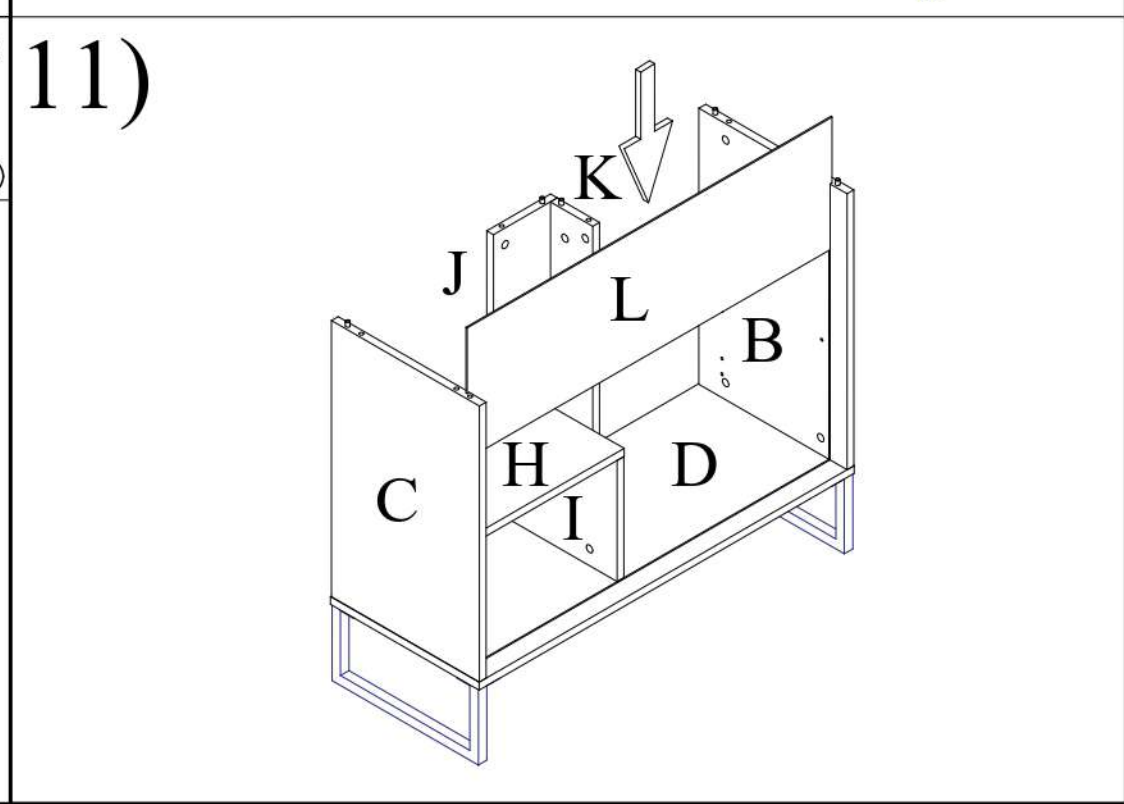
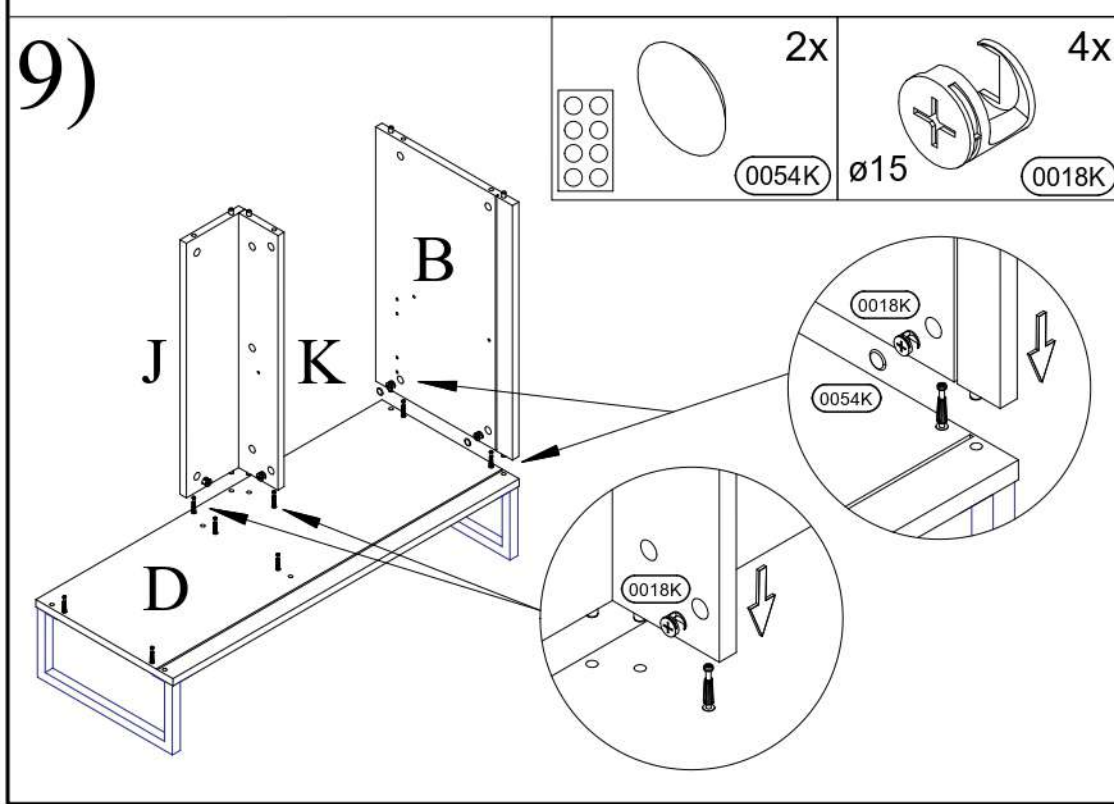
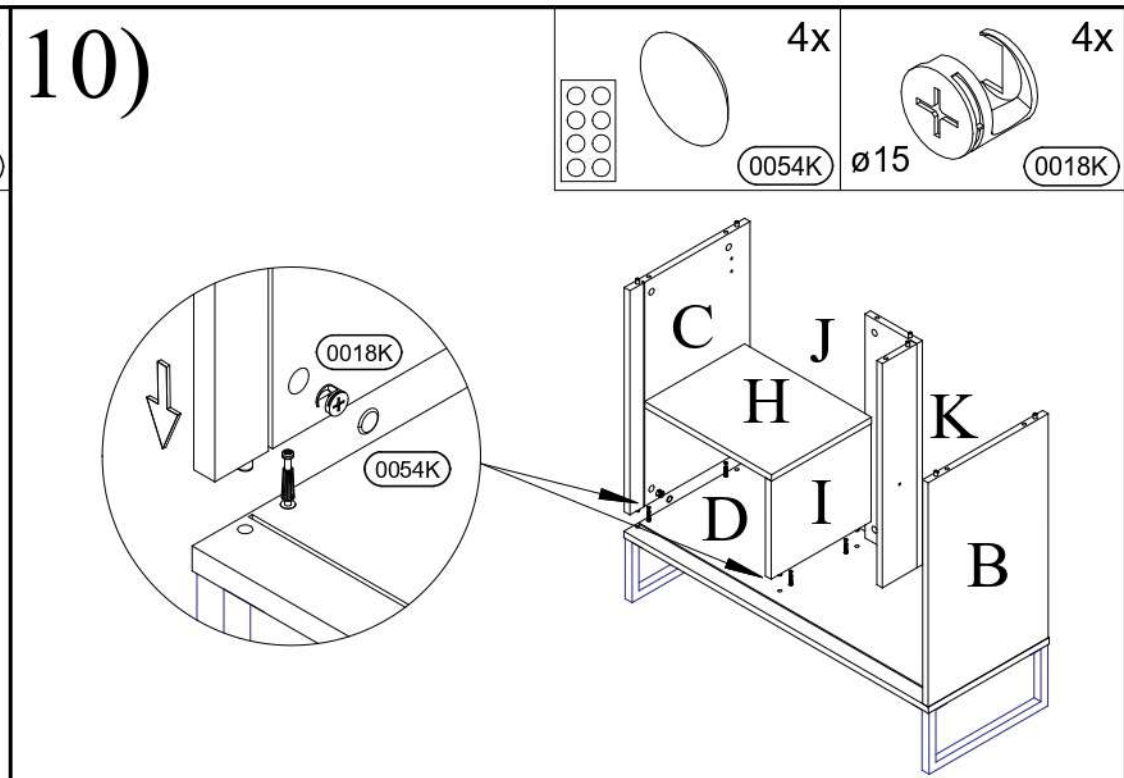
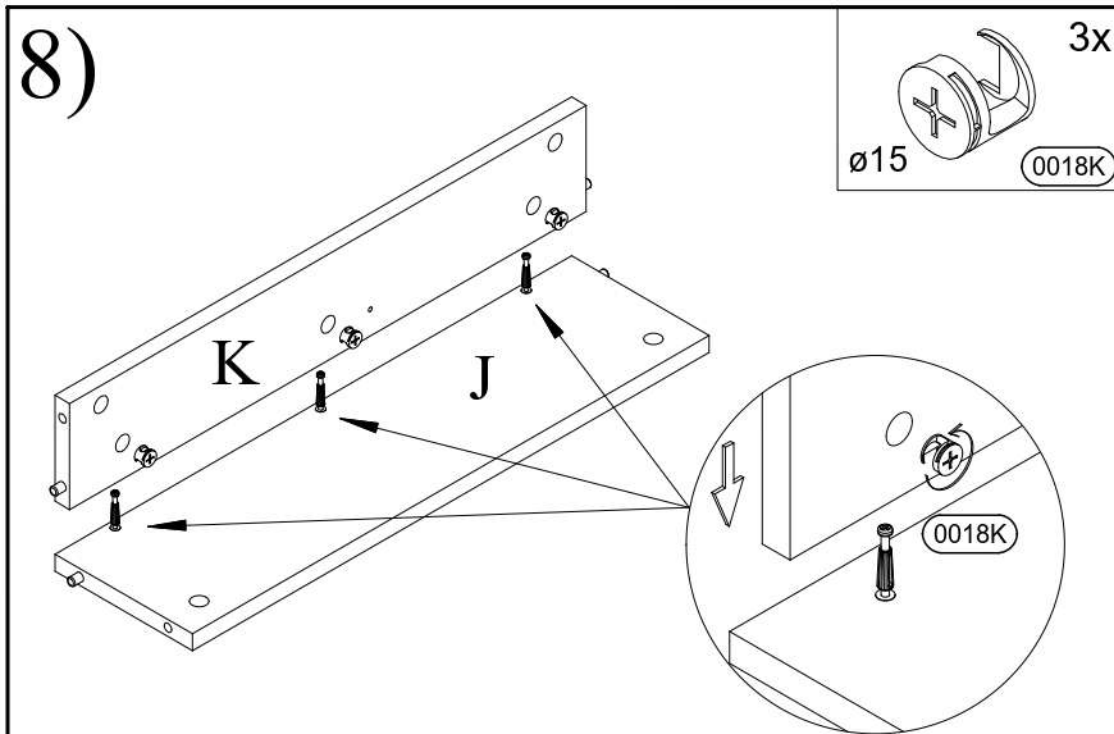

12)

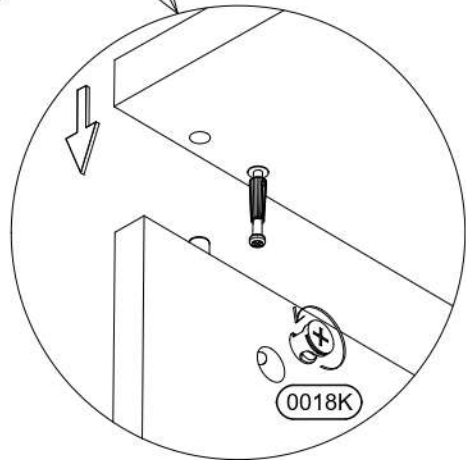
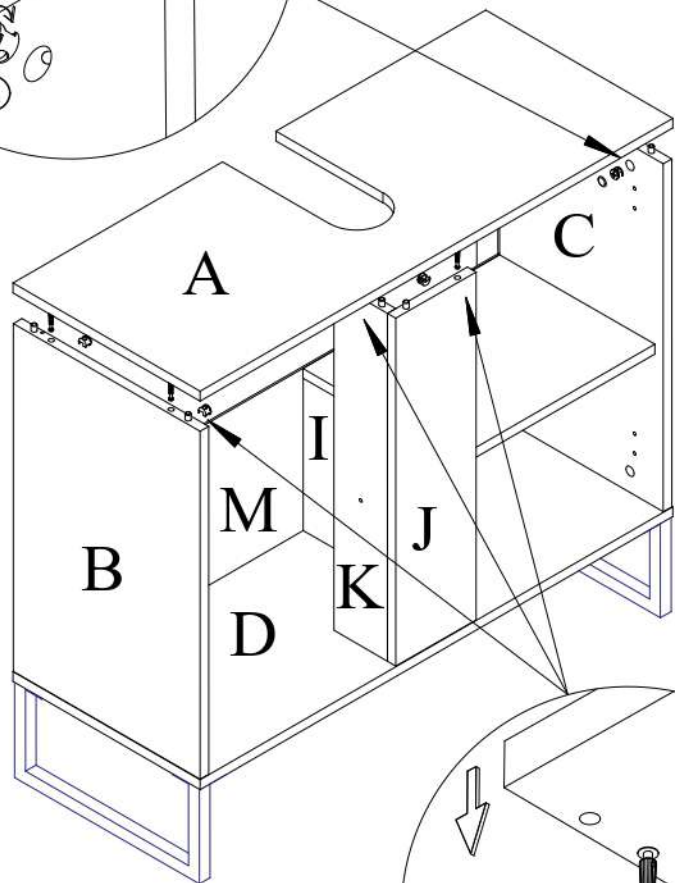
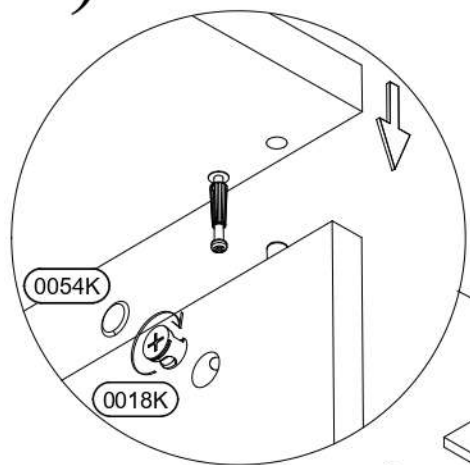
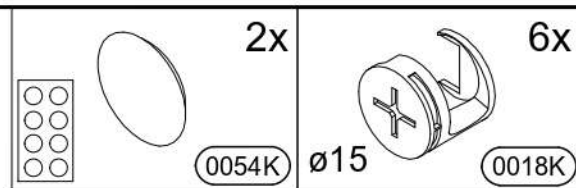

13)

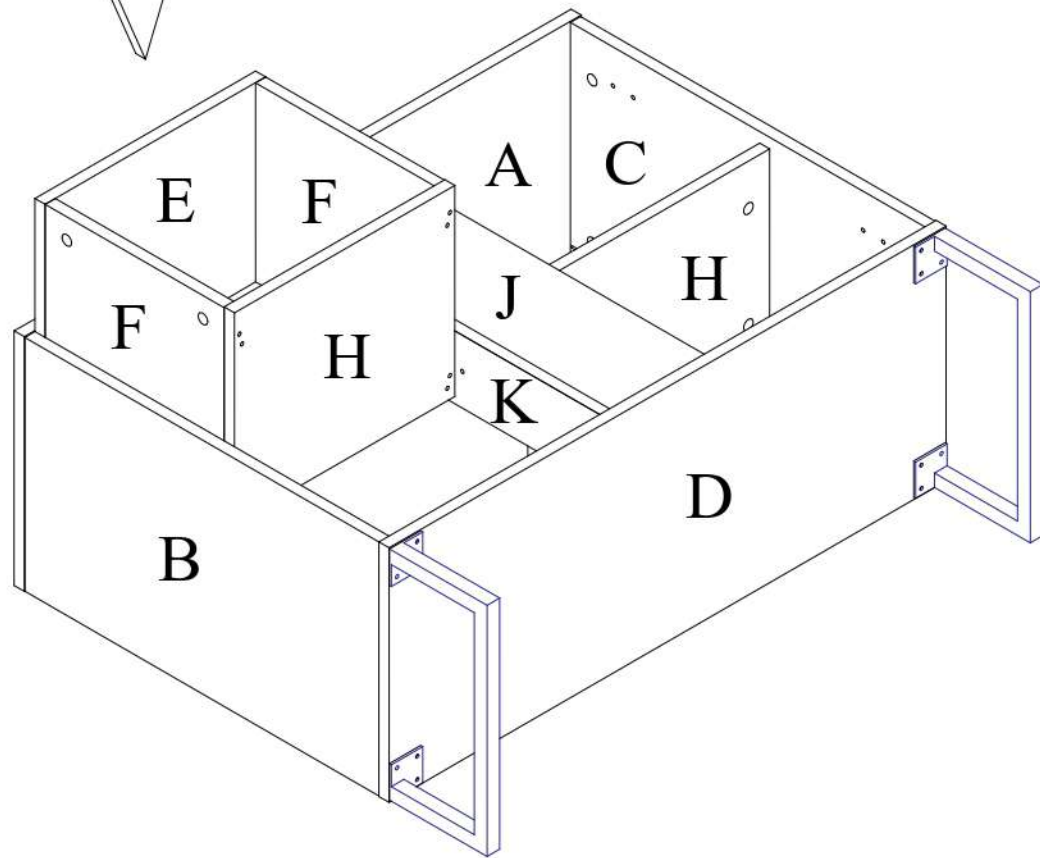
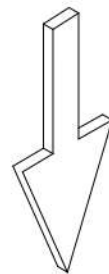

14)

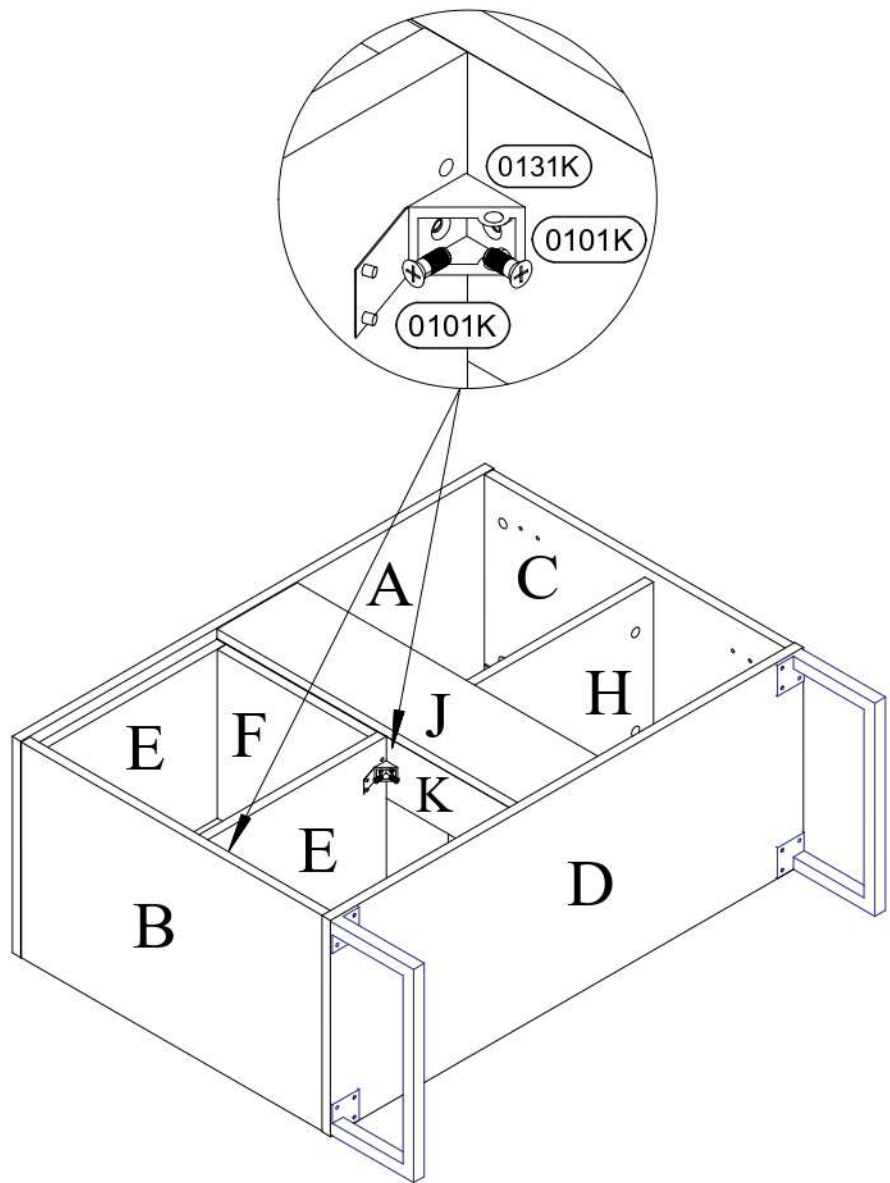
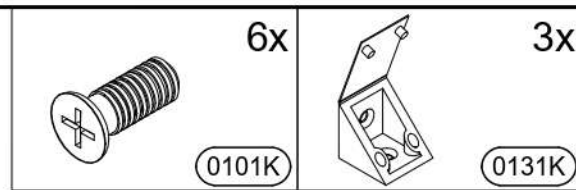

15)

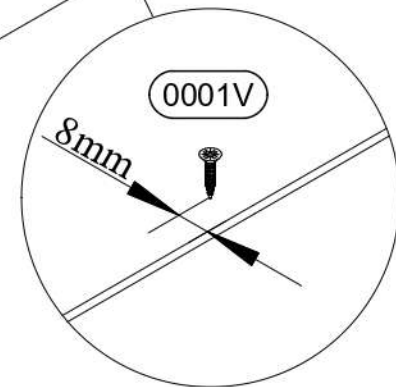
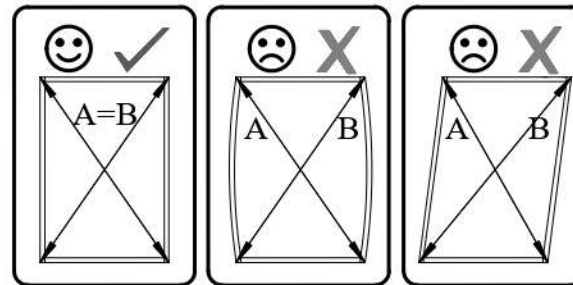
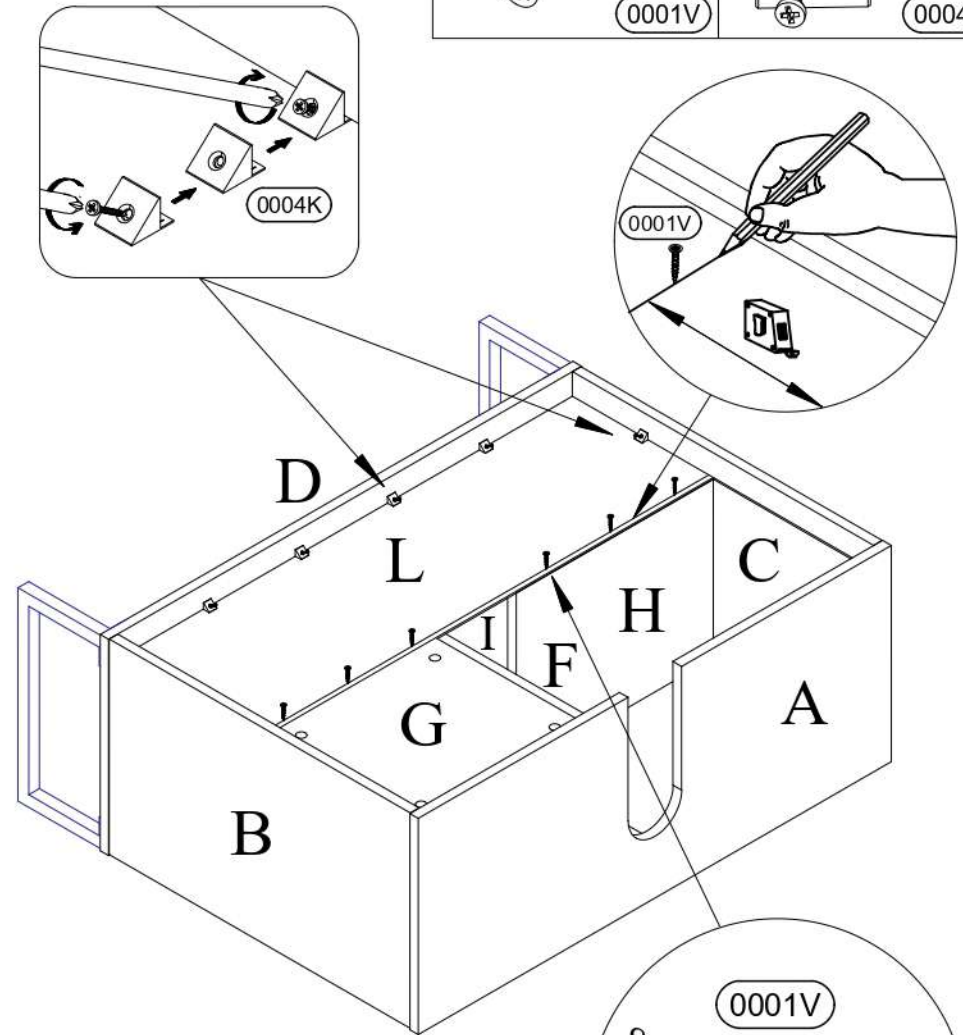
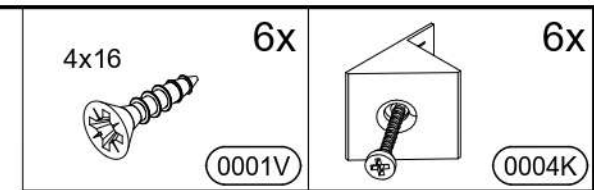

16)

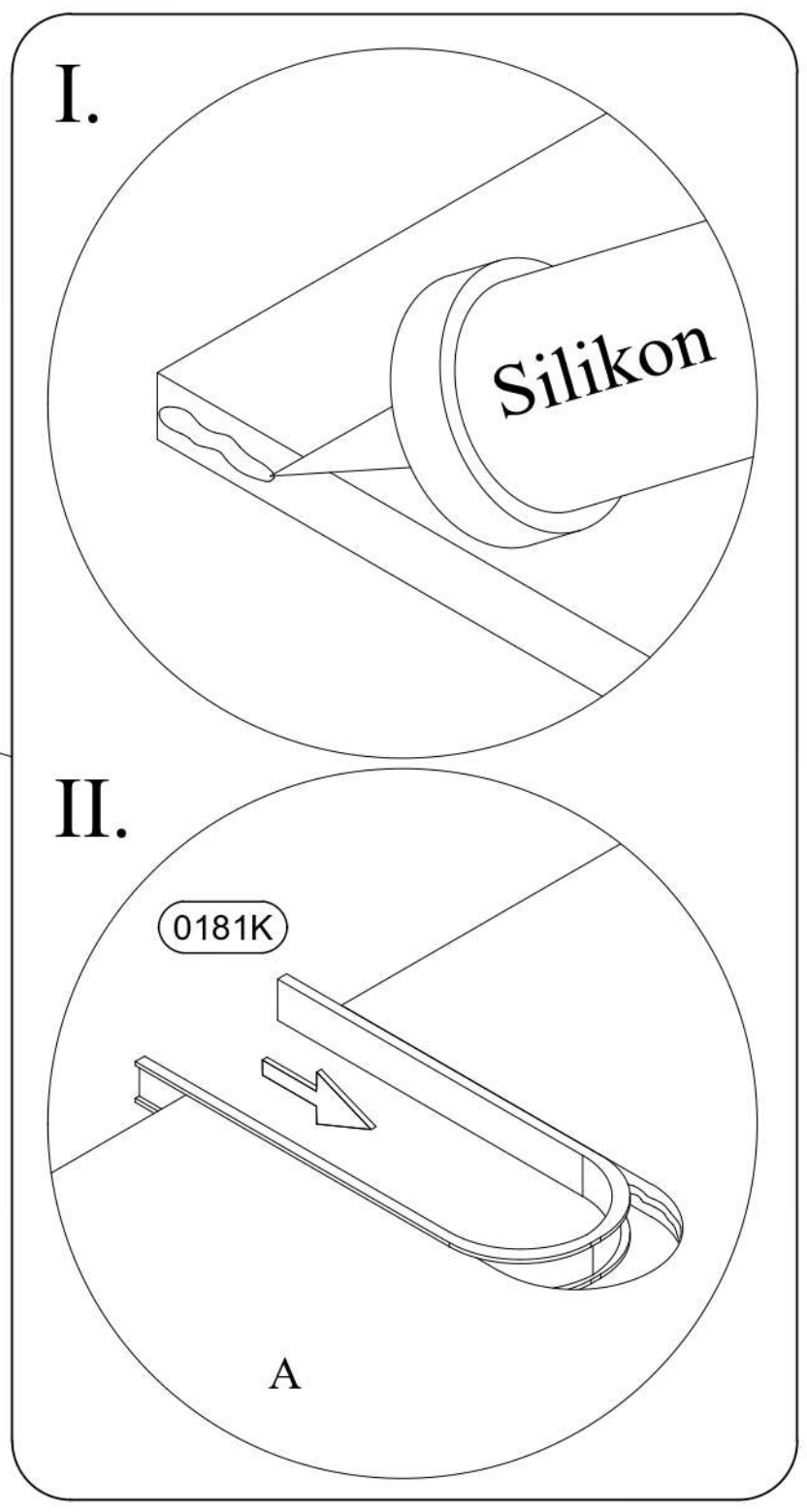
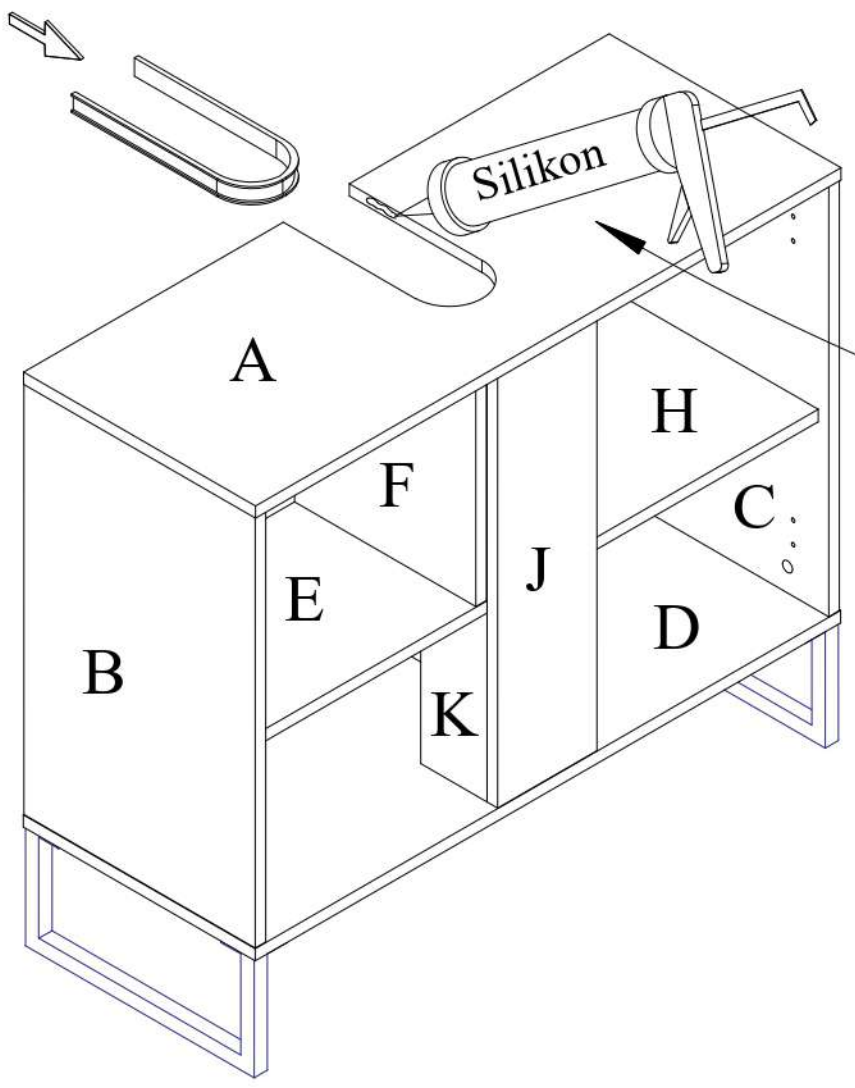
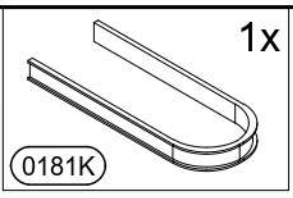



# 17)

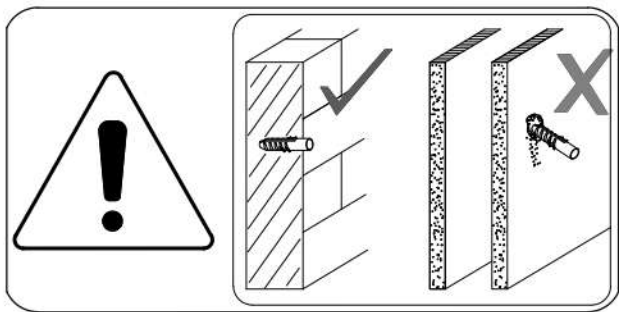
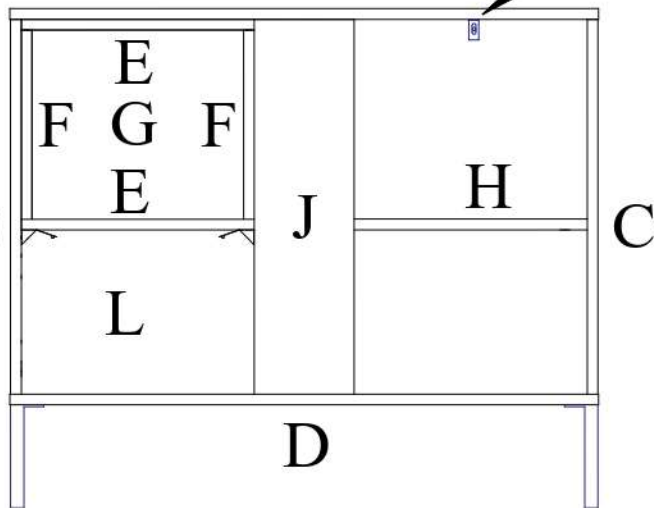
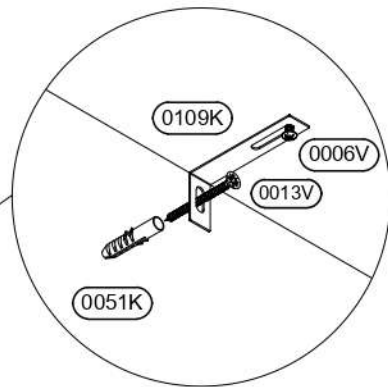
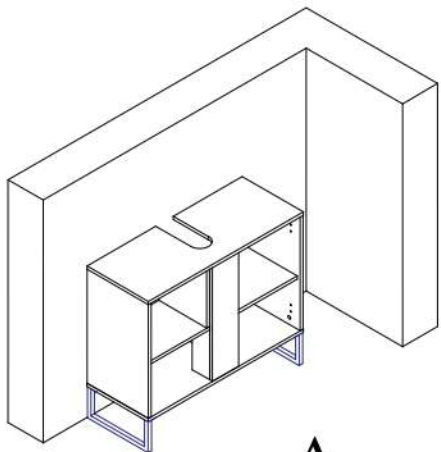
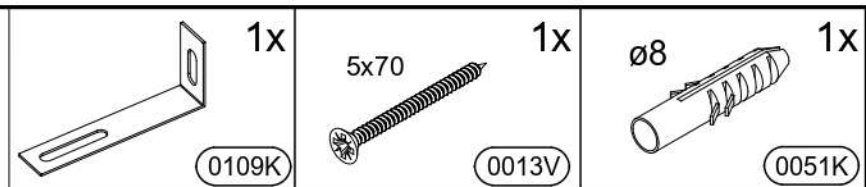

# 18)

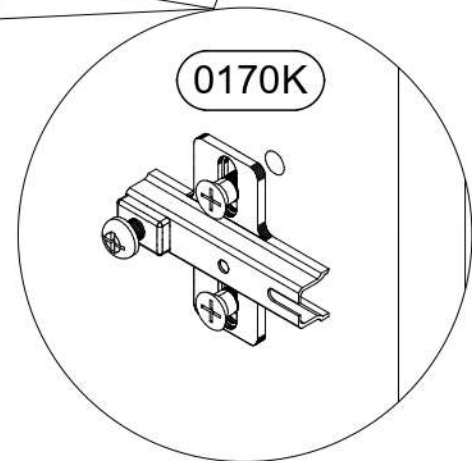
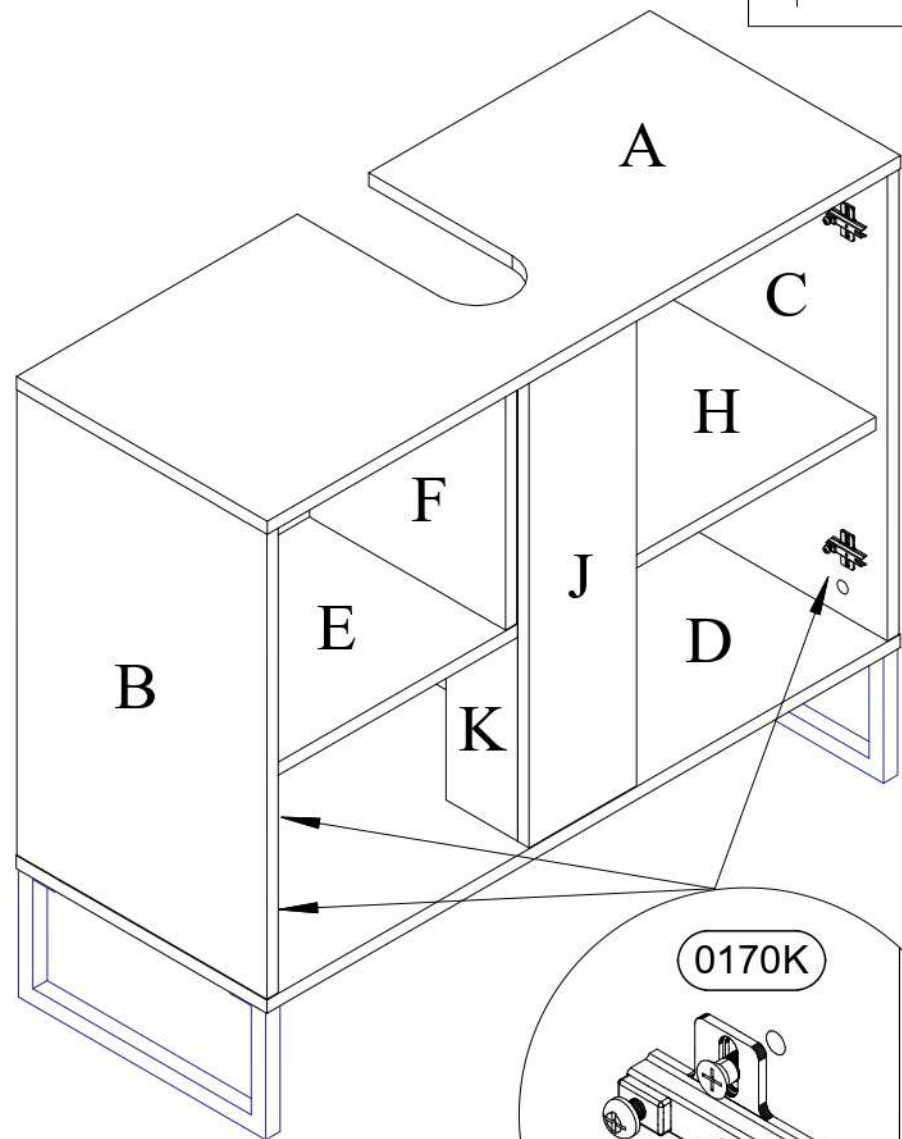
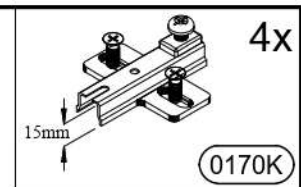

# 19)

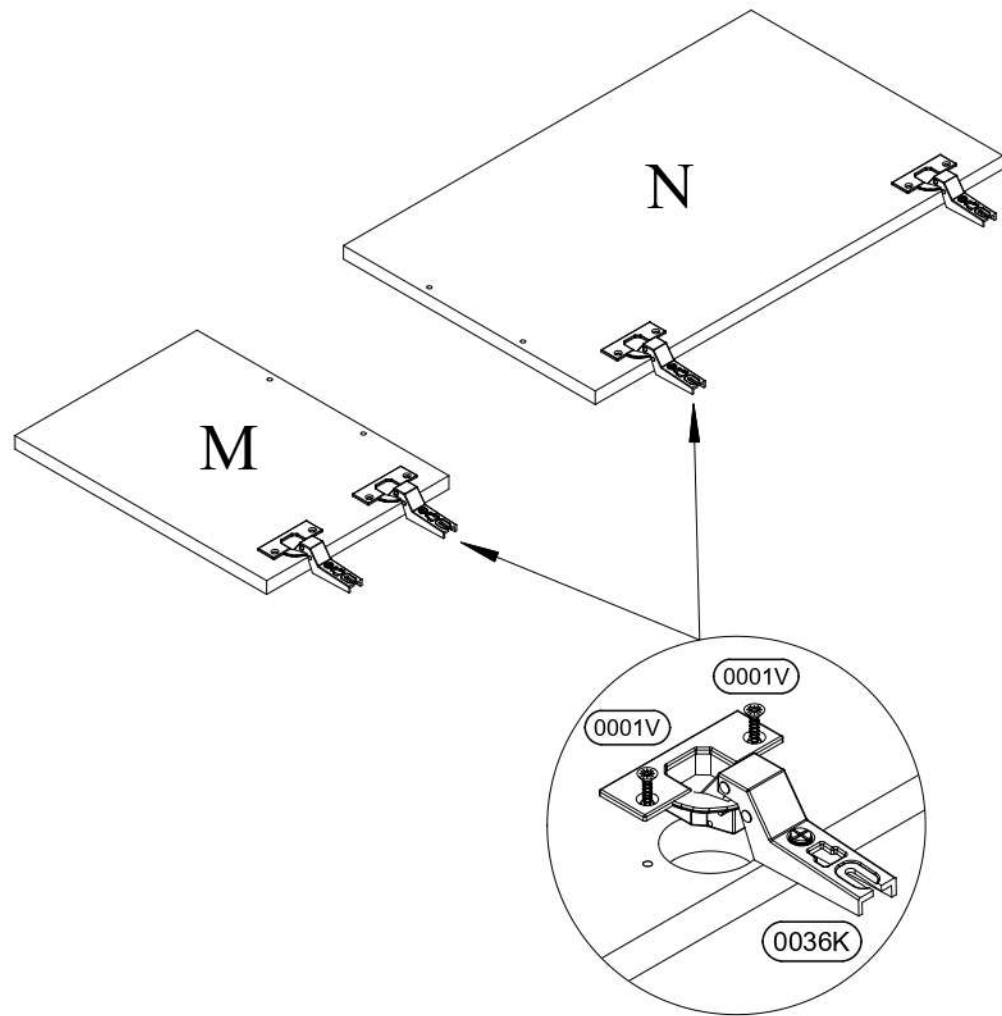
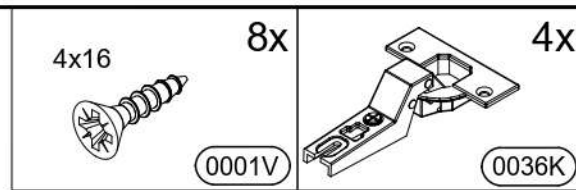

# 20)

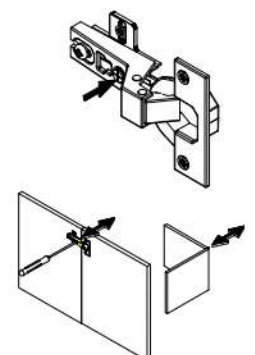
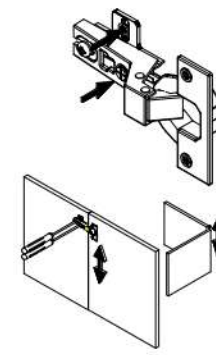
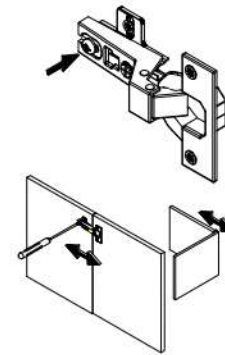
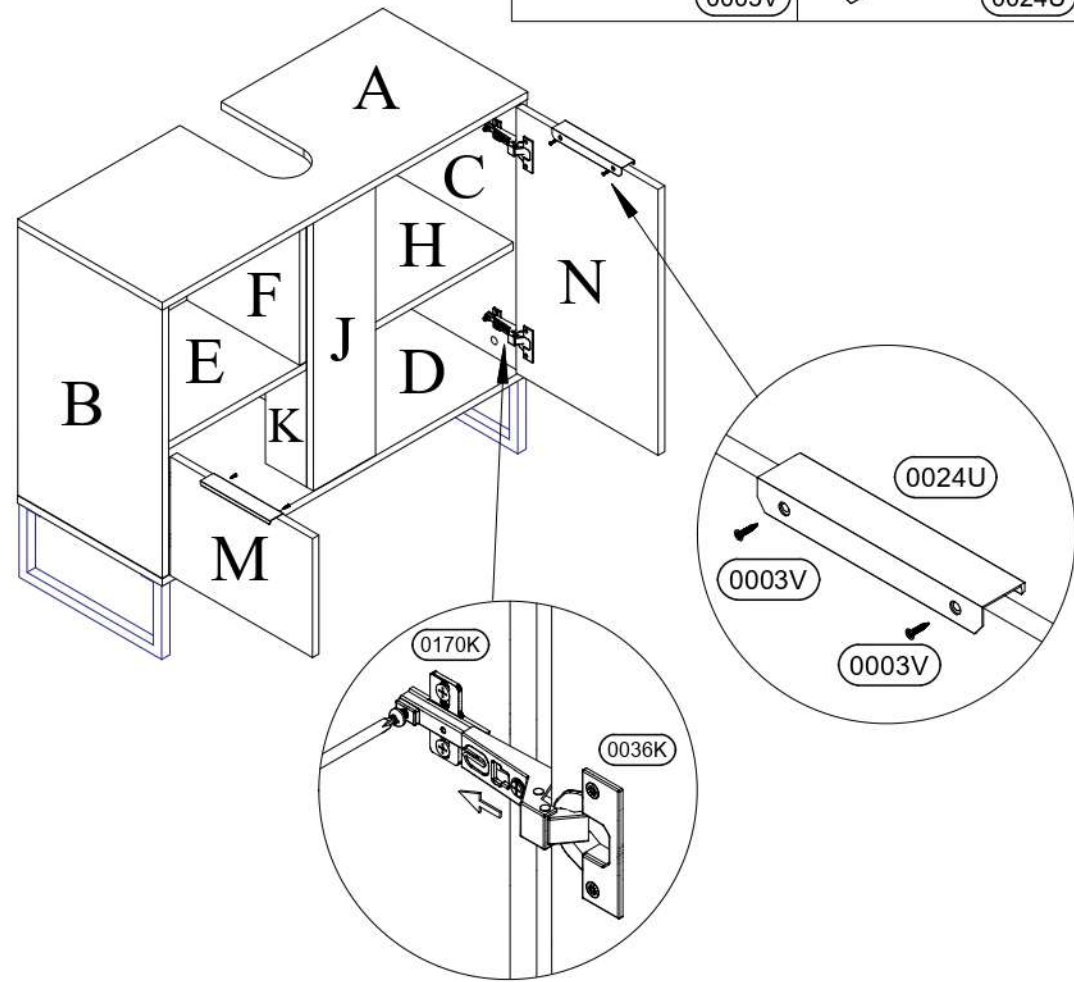
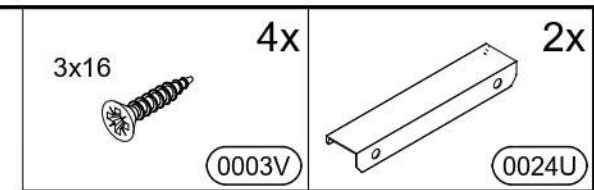

21)

