

# DOLI 180x200

Art.-Nr.

398 697  
398 698  
398 699  
398 700

414 791  
414 795

1836  
787  
2032  
mm

1/6  
V3  
46-2025

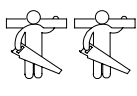

120 min

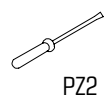

0,5 kg



3m

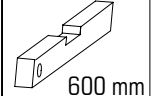

600 mm



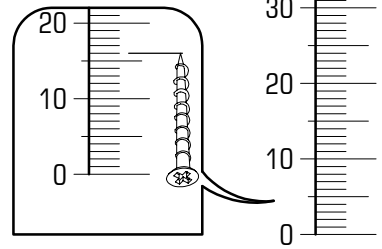
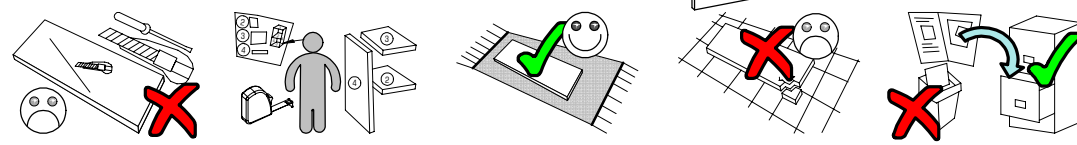
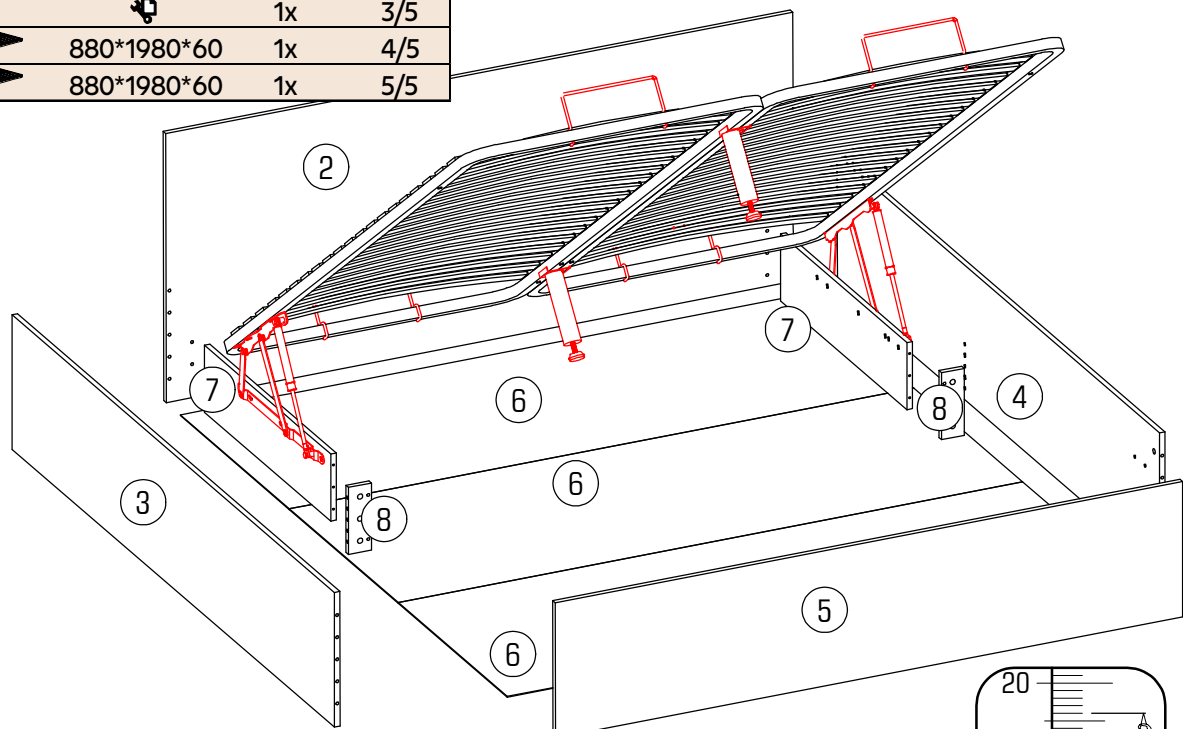
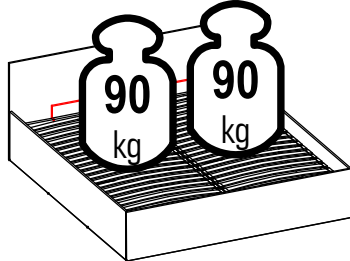

ID	ID				
21621	②	1836*780*16	1x	1/5	
21587	③	2000*390*16	1x	2/5	
21588	④	2000*390*16	1x	2/5	
21622	⑤	1836*392*16	1x	2/5	
21623	⑥	676*1828*3	3x	1/5	
21853	⑦	784*194*16	2x	2/5	
21854	⑧	67*194*16	2x	2/5	
			1x	3/5	
			880*1980*60	1x	4/5
			880*1980*60	1x	5/5

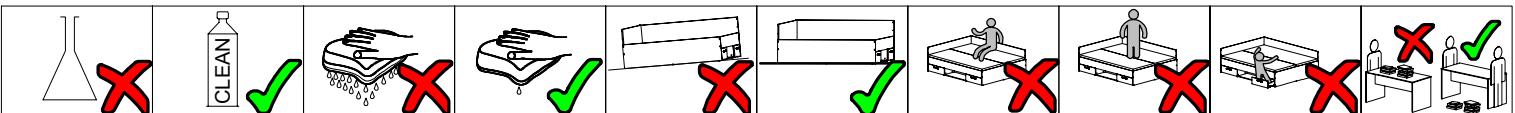

21102,00		Ø1,6x20	22205,02		Ø5,0x16	22453,00		M6,0x25	22300,00		Ø7x50	37149,00		750 N	37147,00		31098,00		30x30x30	37150,00						
A	100x		B	16x		C	12x		D	18x		E	2x		F	4x	G	2x	H	2x						
22600,01		4	9323,00		M6,0	27000,00		Ø8x30	30097,00		10x	70013,01		Ø15x13	70027,01		12x	Q1	12x	Q2	18x					
J	1x		K	12x		L	12x		M	10x		N	12x		P	12x	Q1	12x	Q2	18x						
31106,00		2x	37146,00		2x	37149,00		M6,0x40	37149,00		4x	37149,00		1x	37149,00		1x	37149,00		M6,0	37146,00		M8,0x40	37146,00		2x
R	2x		S	2x		T	6x		U	4x		V	1x		W	1x	X	6x	Y	2x	Z	2x				



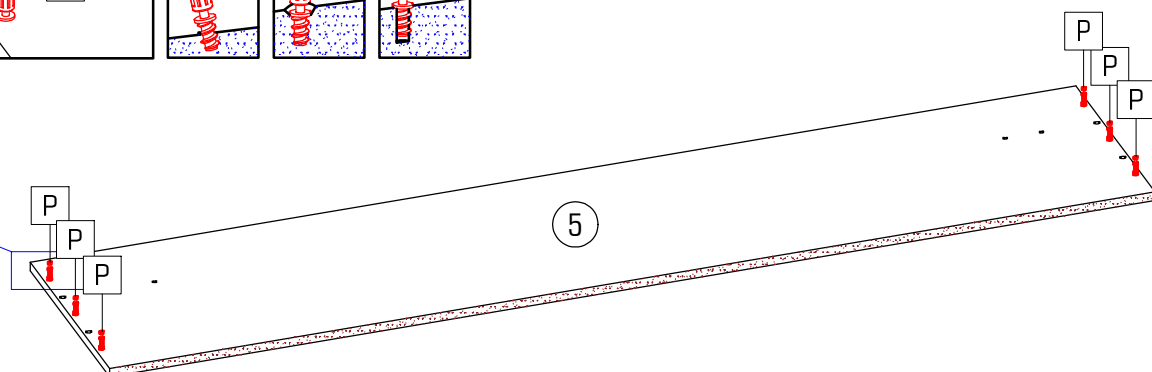
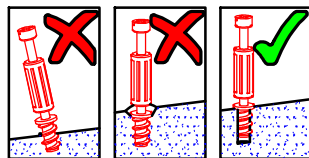
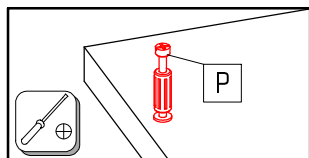
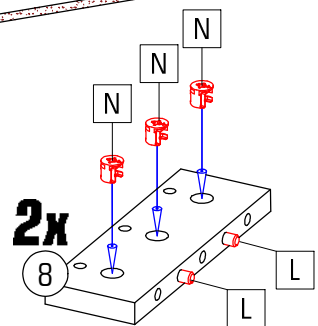
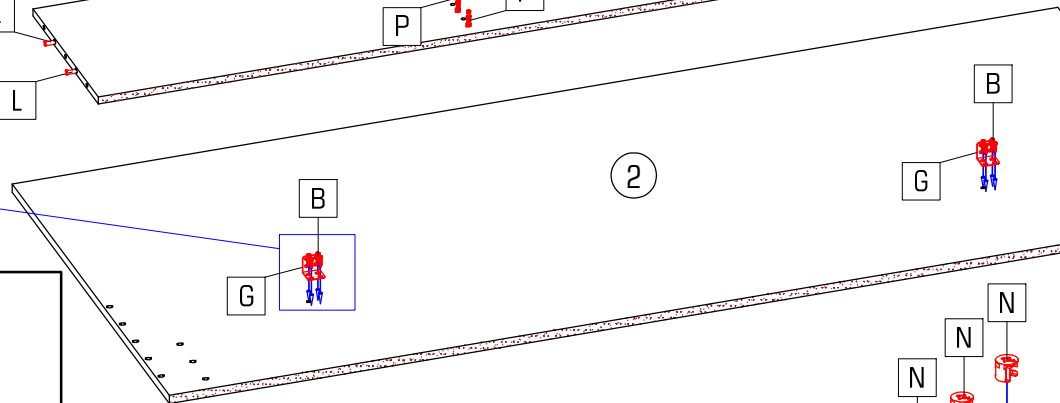
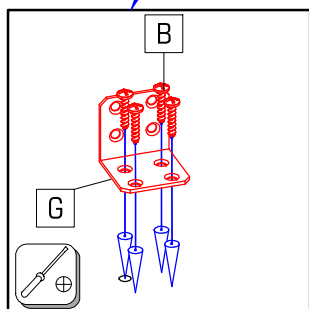
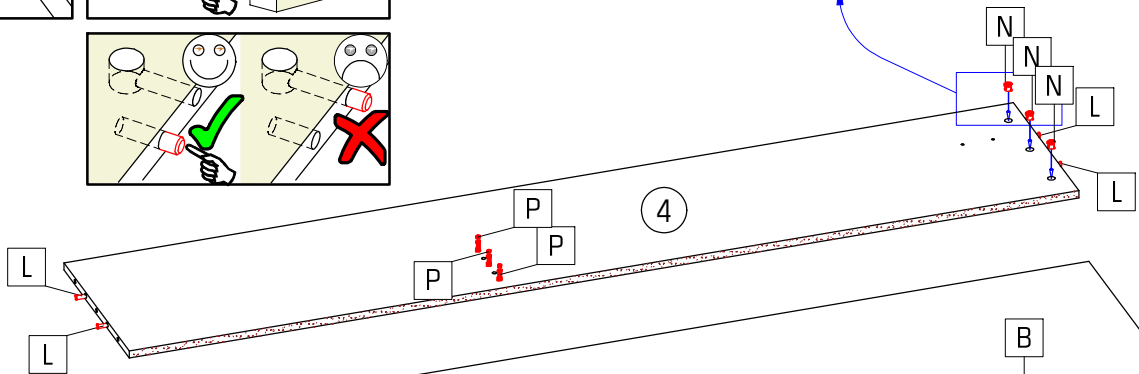
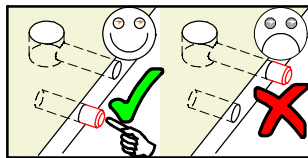
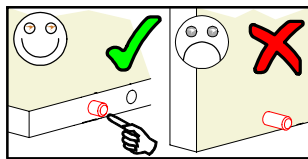
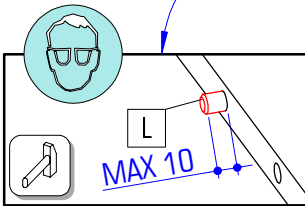
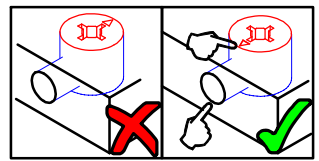
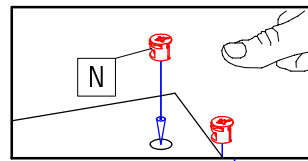
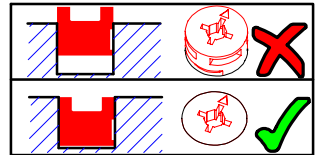
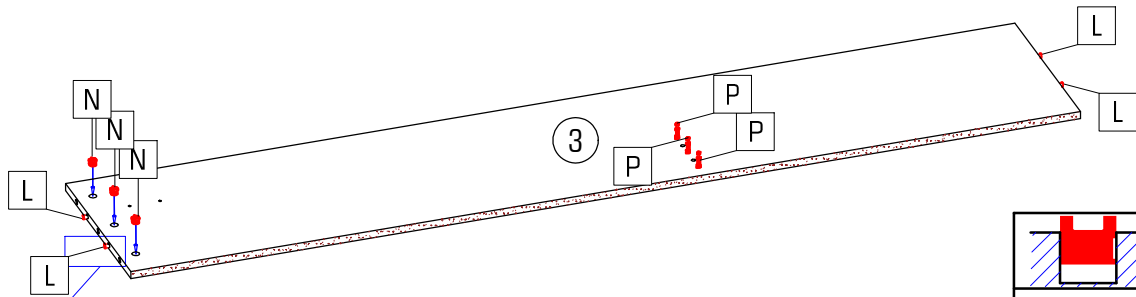
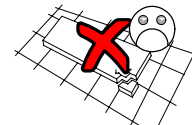
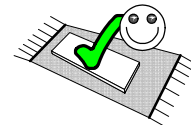

# 2/6 DOLI 180x200

				
B 8x	G 2x	L 12x	N 12x	P 12x



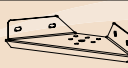

# DOLI 180x200 3/6

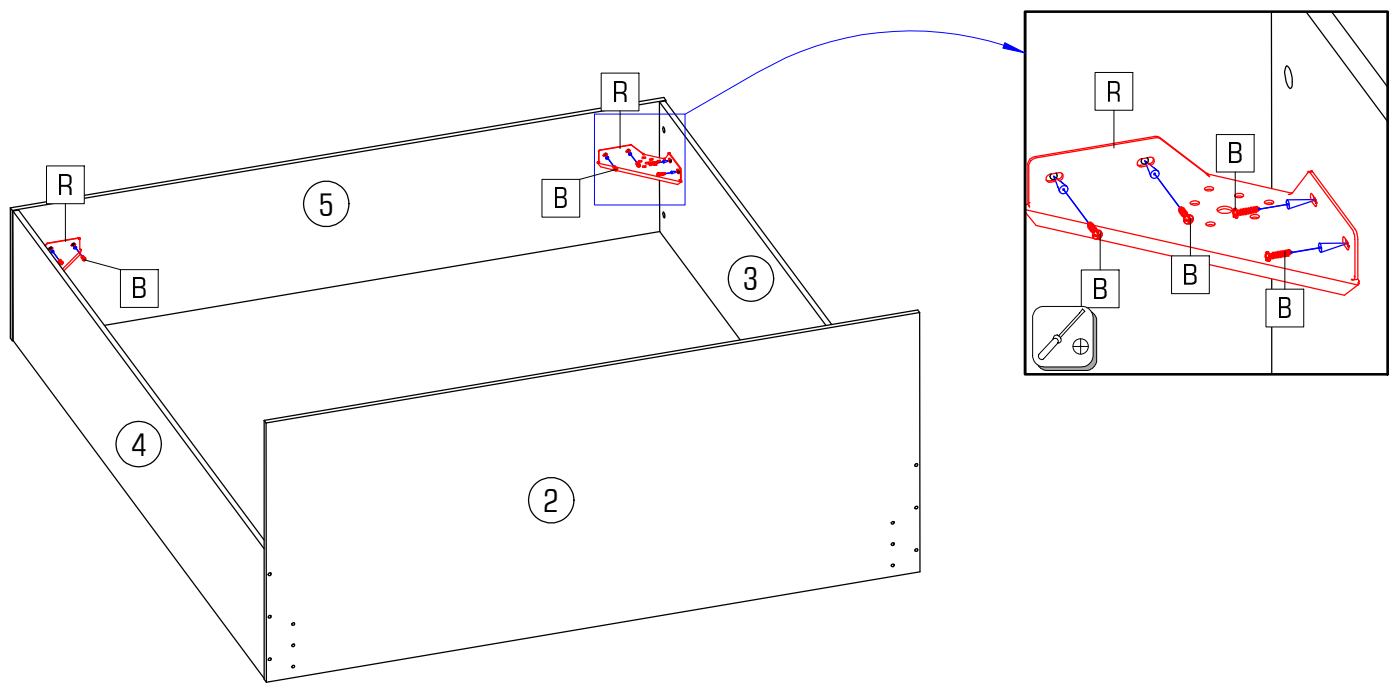
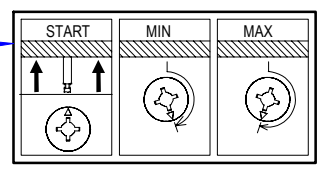
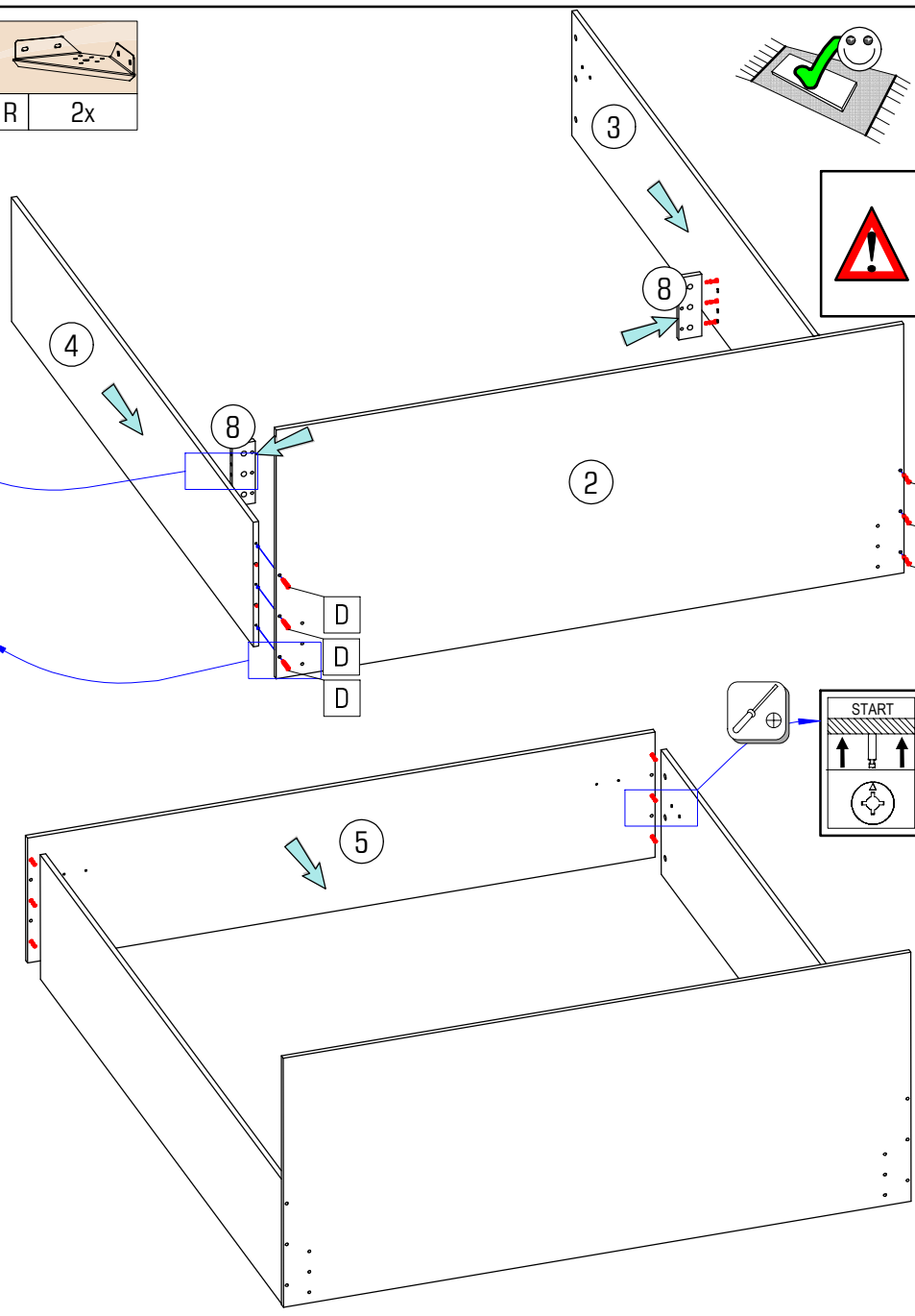
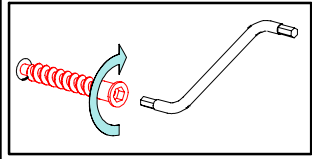
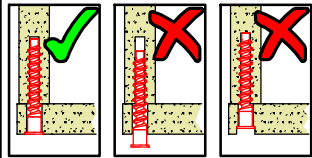
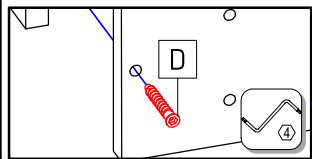
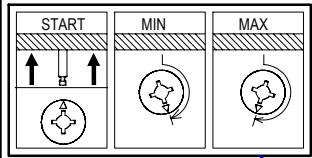
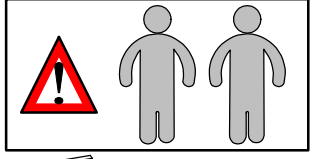
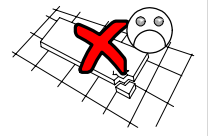
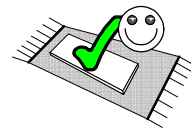

		
B	D	R
8x	6x	2x

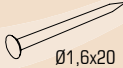



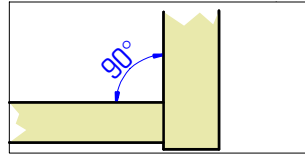
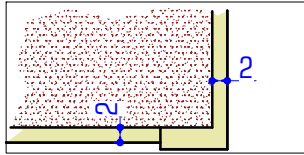
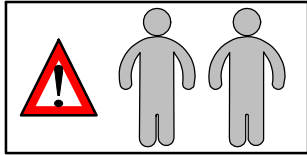

# 4/6 DOLI 180x200

	
A 100x	M 10x





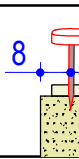



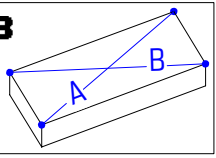

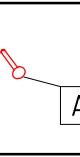

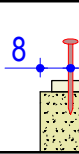





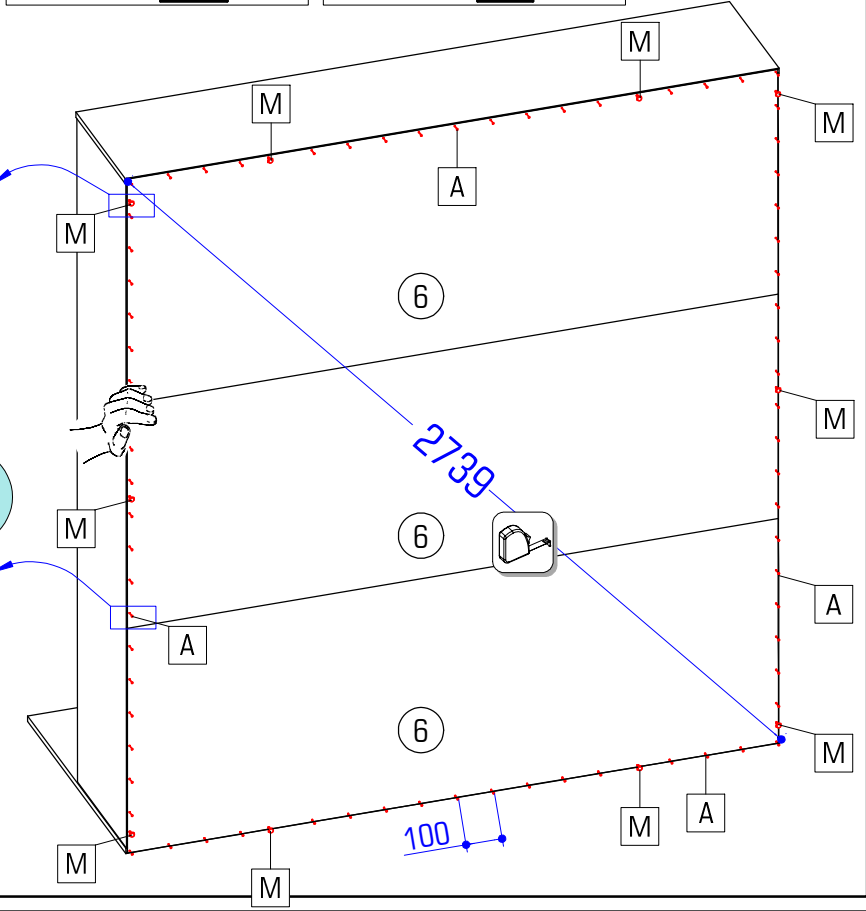







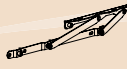
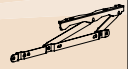

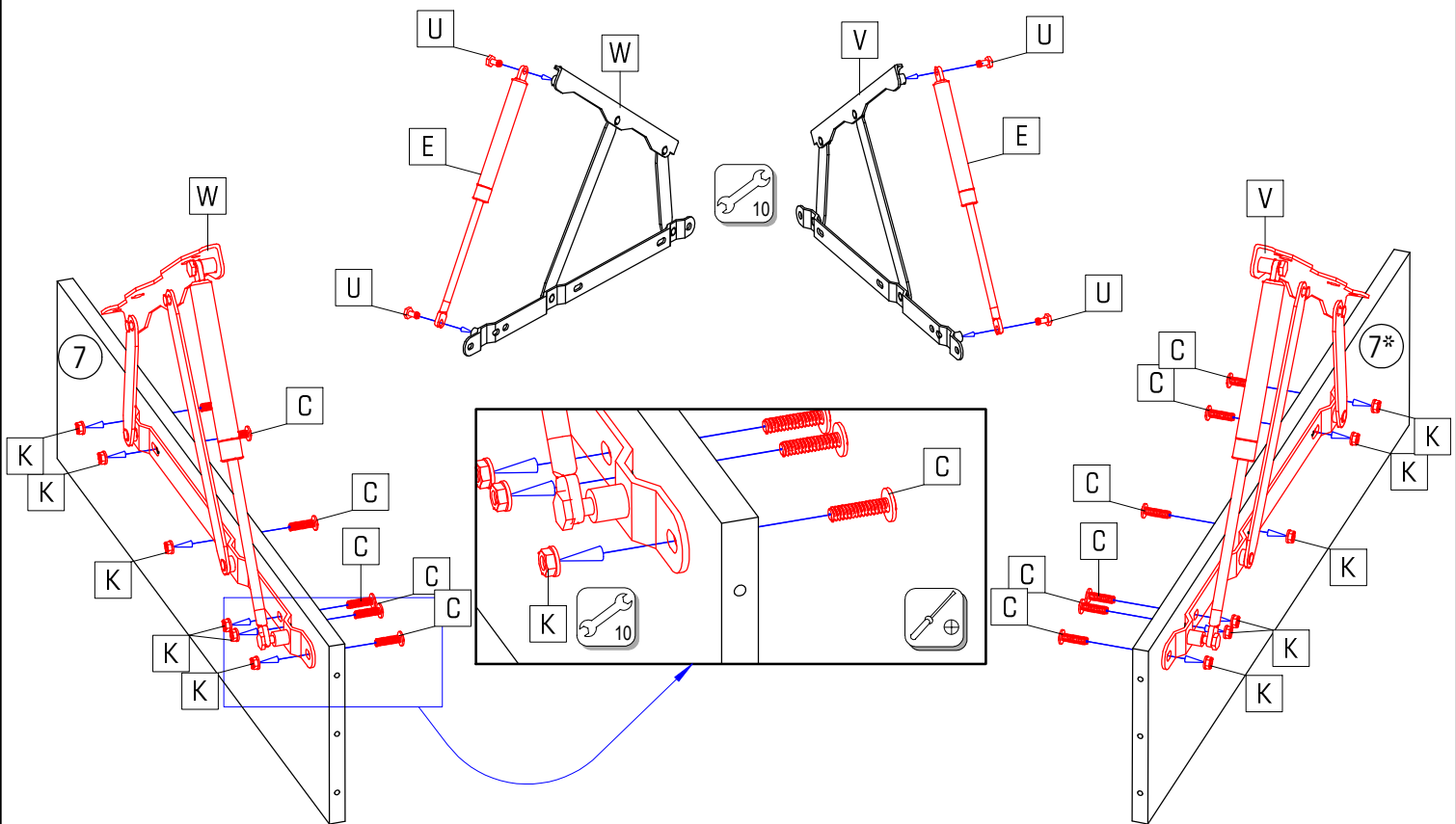

					
C 12x	E 2x	K 12x	U 4x	V 1x	W 1x

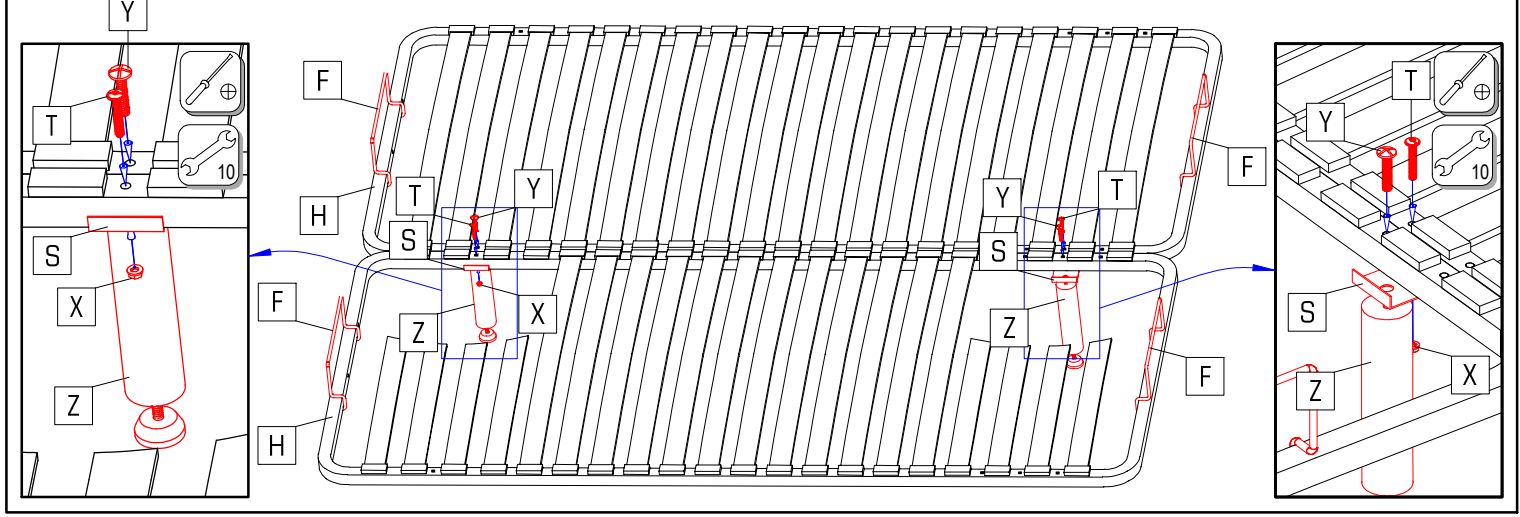
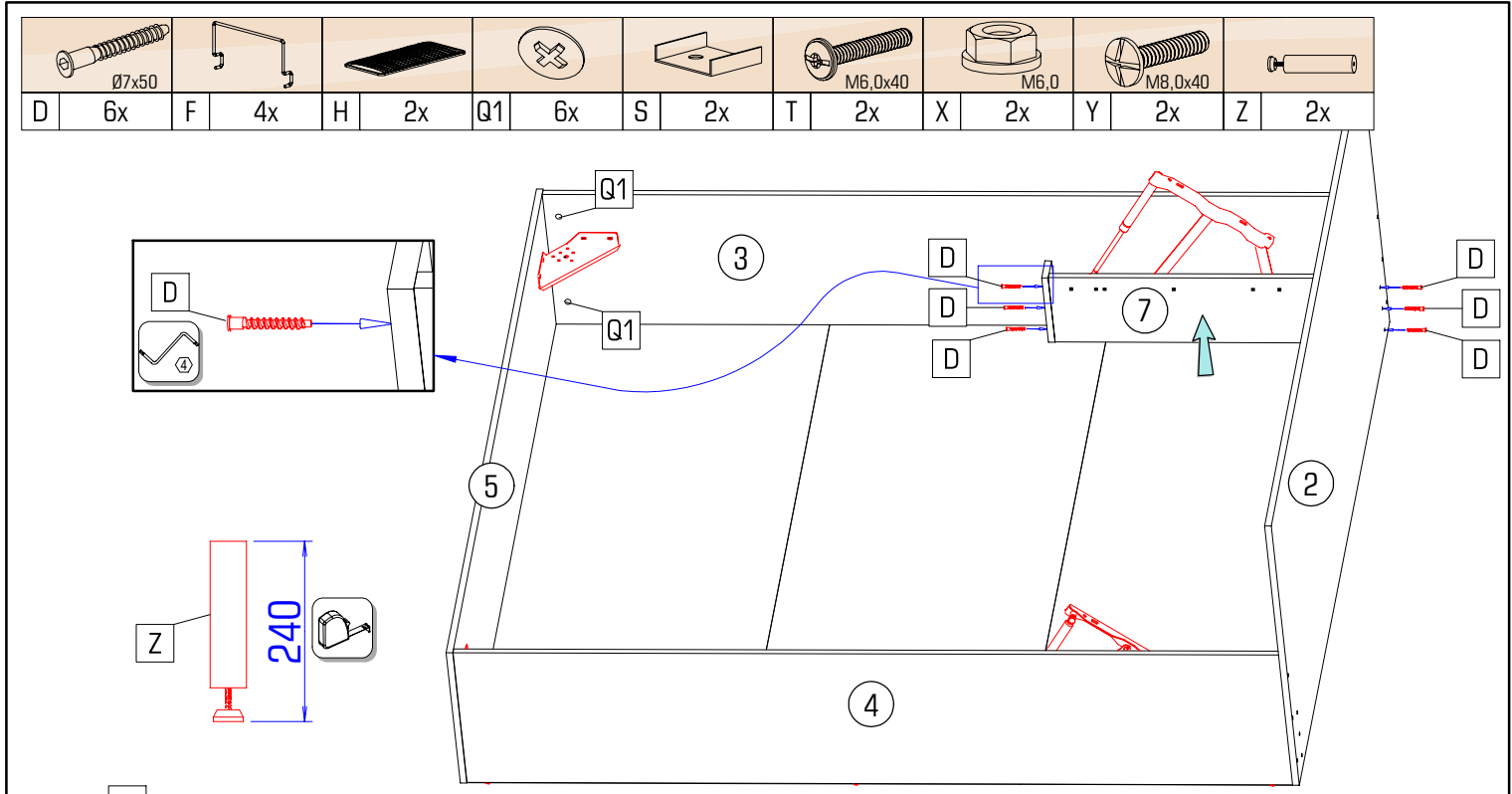
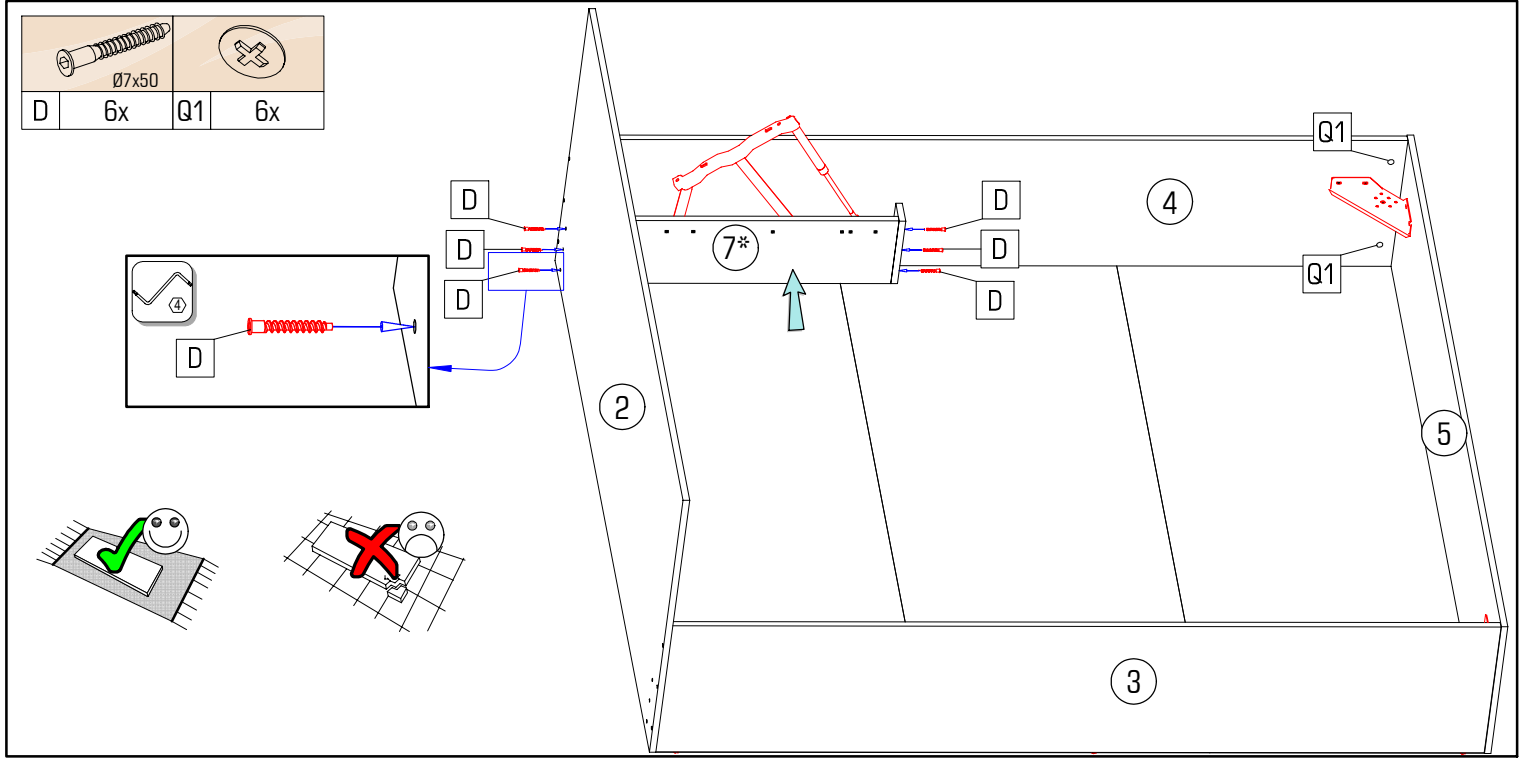

# DOLI 180x200 5/6



# 6/6 DOLI 180x200

Q2	M6,0x40	M6,0
18x	4x	4x
T	X	X

M6,0x25	M6,0x40
C 12x	T 4x

