

# SIRISS NEW

Art.-Nr.

396 947  
396 948

1085  
754  
500  
mm

1/6  
vo  
27-2024

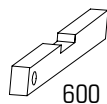
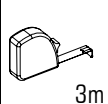
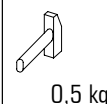
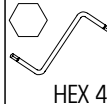
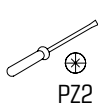
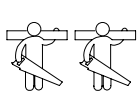

ID	D	Dimensions	Qty	Ratio
21464	②	1085*500*16	1x	1/1
21465	③	734*390*16	1x	1/1
21466	④	734*390*16	1x	1/1
21467	⑤	734*390*16	1x	1/1
21468	⑥	376*389*16	1x	1/1
21469	⑦	577*110*16	2x	1/1
21470	⑧	376*90*16	1x	1/1
21471	⑨	388*474*16	1x	1/1
21472	⑩	388*156*16	1x	1/1
21473	⑪	350*110*16	1x	1/1
21474	⑫	320*110*16	1x	1/1
21475	⑬	350*110*16	1x	1/1
12310	⑭	356*350*3	1x	1/1
21476	⑮	642*404*3	1x	1/1

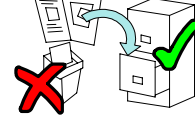
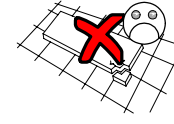
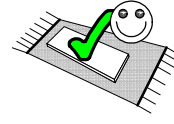
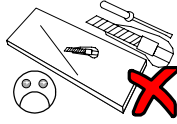

\*L

P

35 kg

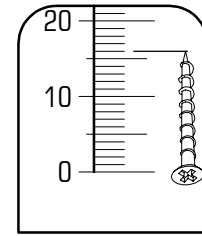
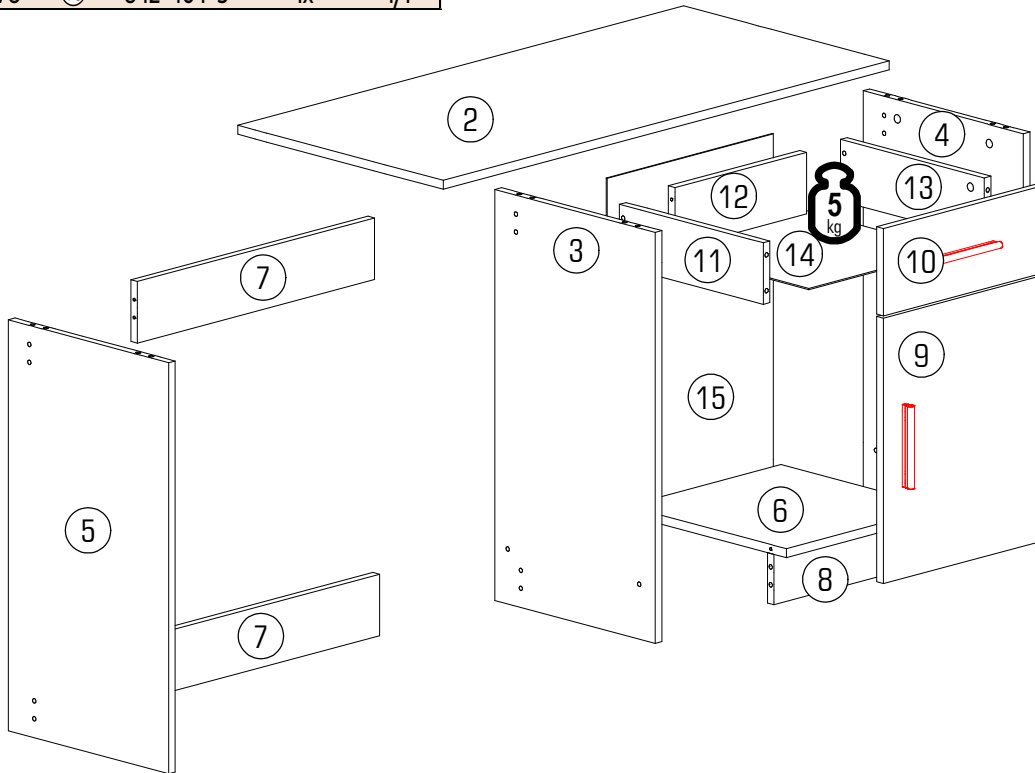
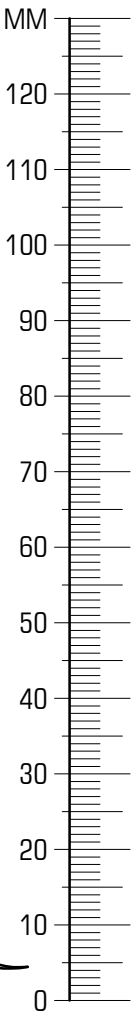
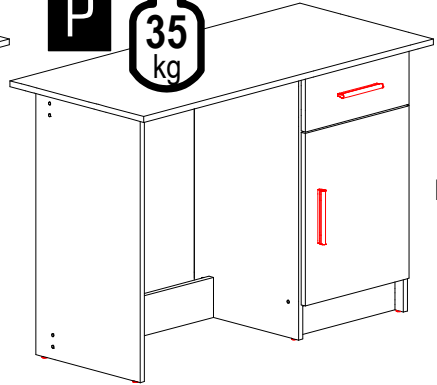
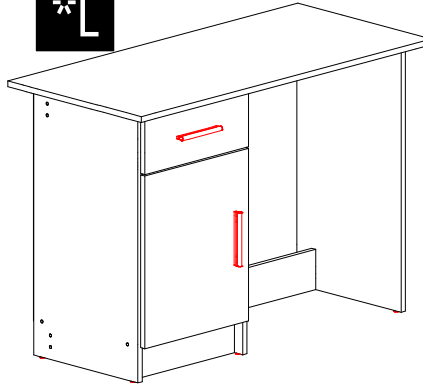

A	16x	B	8x	C	10x	D	1x	E	12x	F	6x	G	25x	H	1x	J	4x
K	2x	L	2x	M	2x	N	6x	P	10x	Q	10x	S	4x	T	3x	U	4x

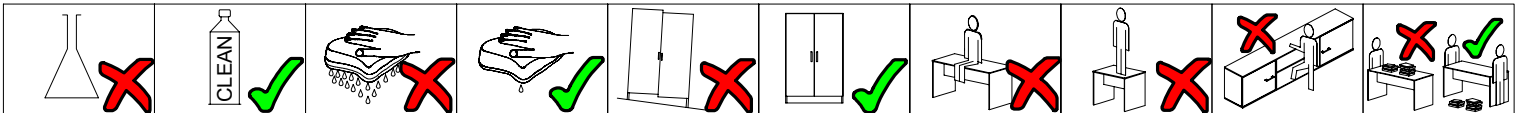

# 2/6 SIRISS NEW

C 10x	E 2x	F 6x	D 1x	M 2x	Q 6x	P 6x	S 4x

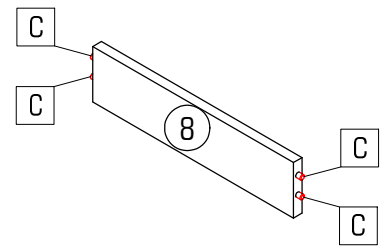
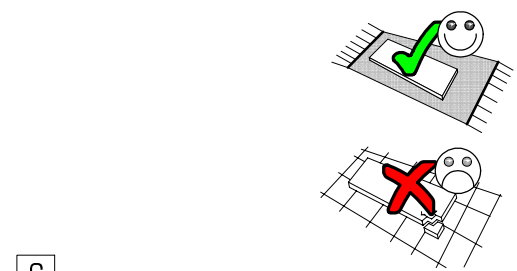
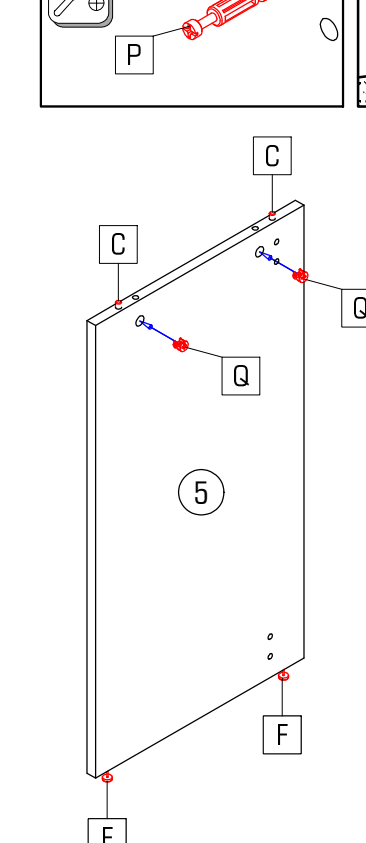
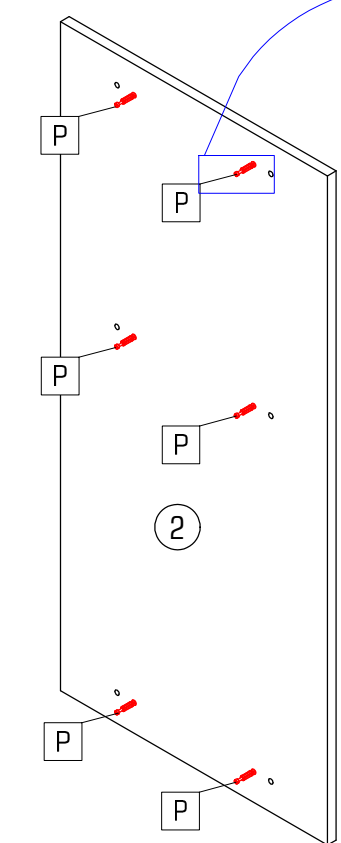
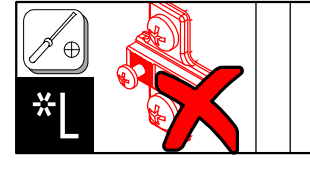
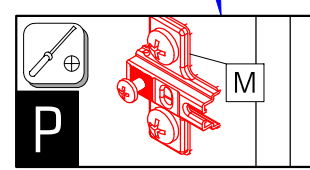
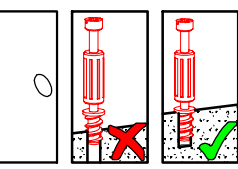
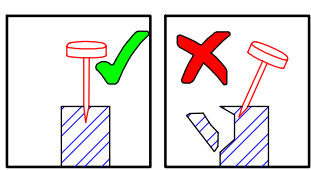
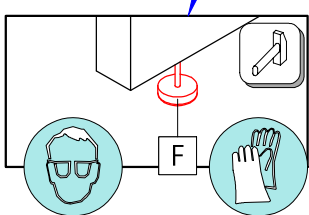
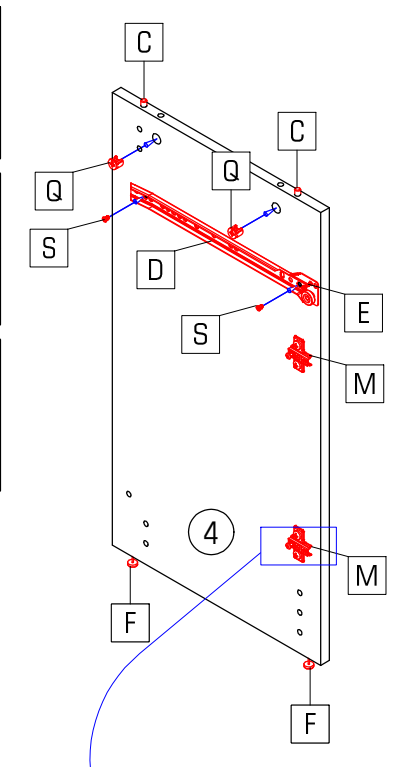
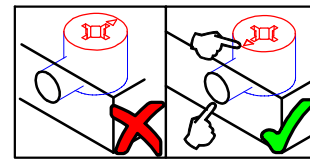
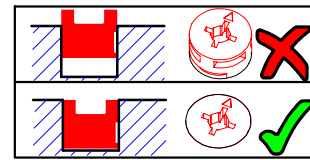
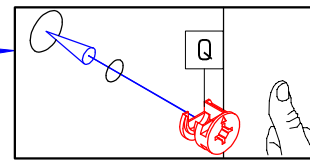
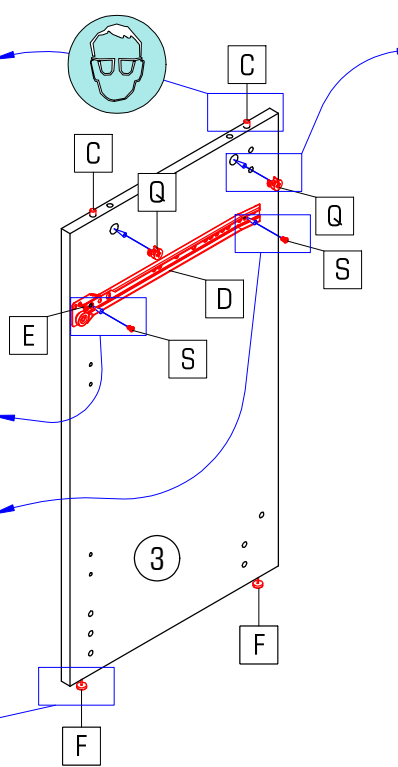
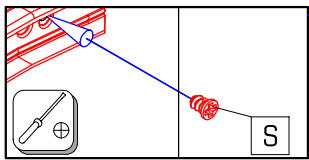
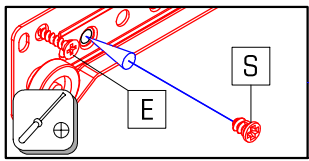
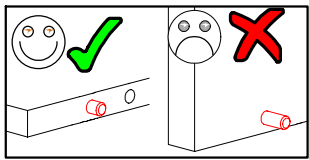
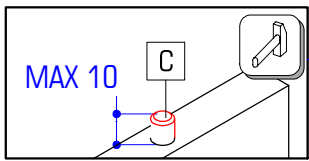

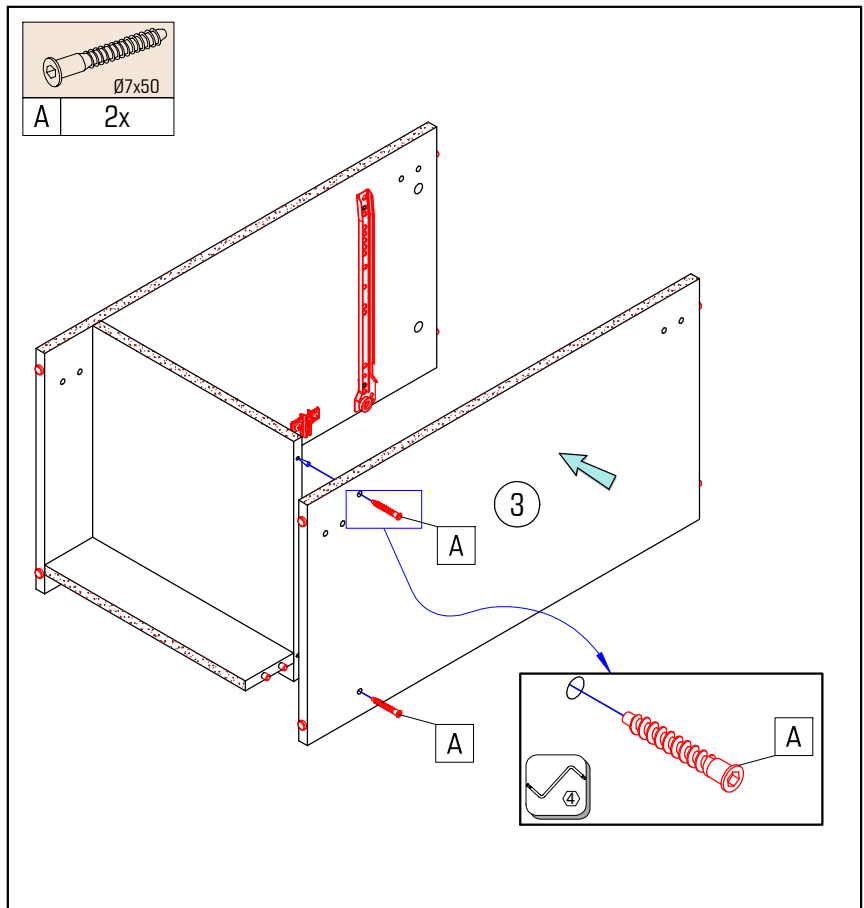
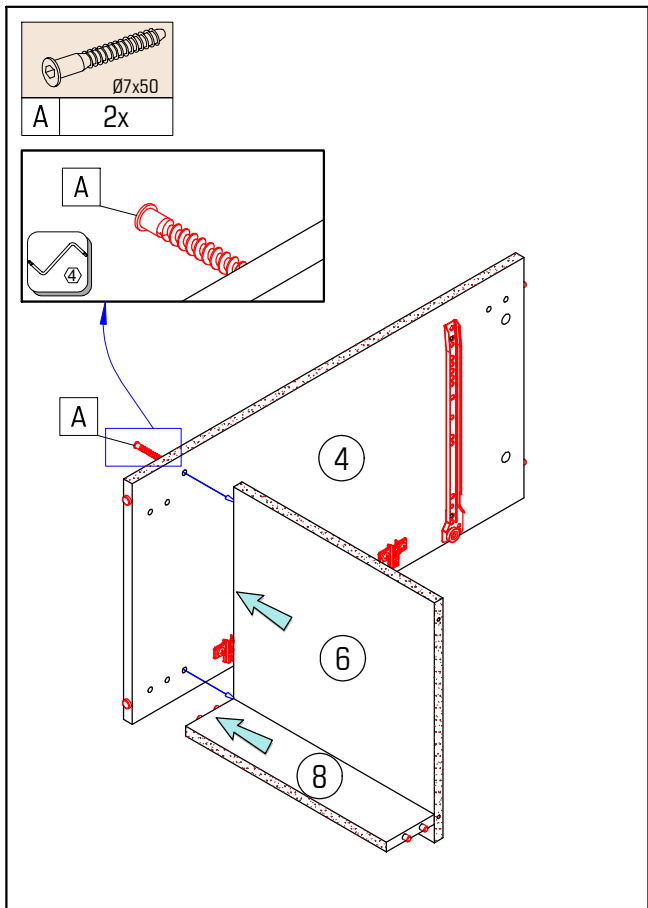
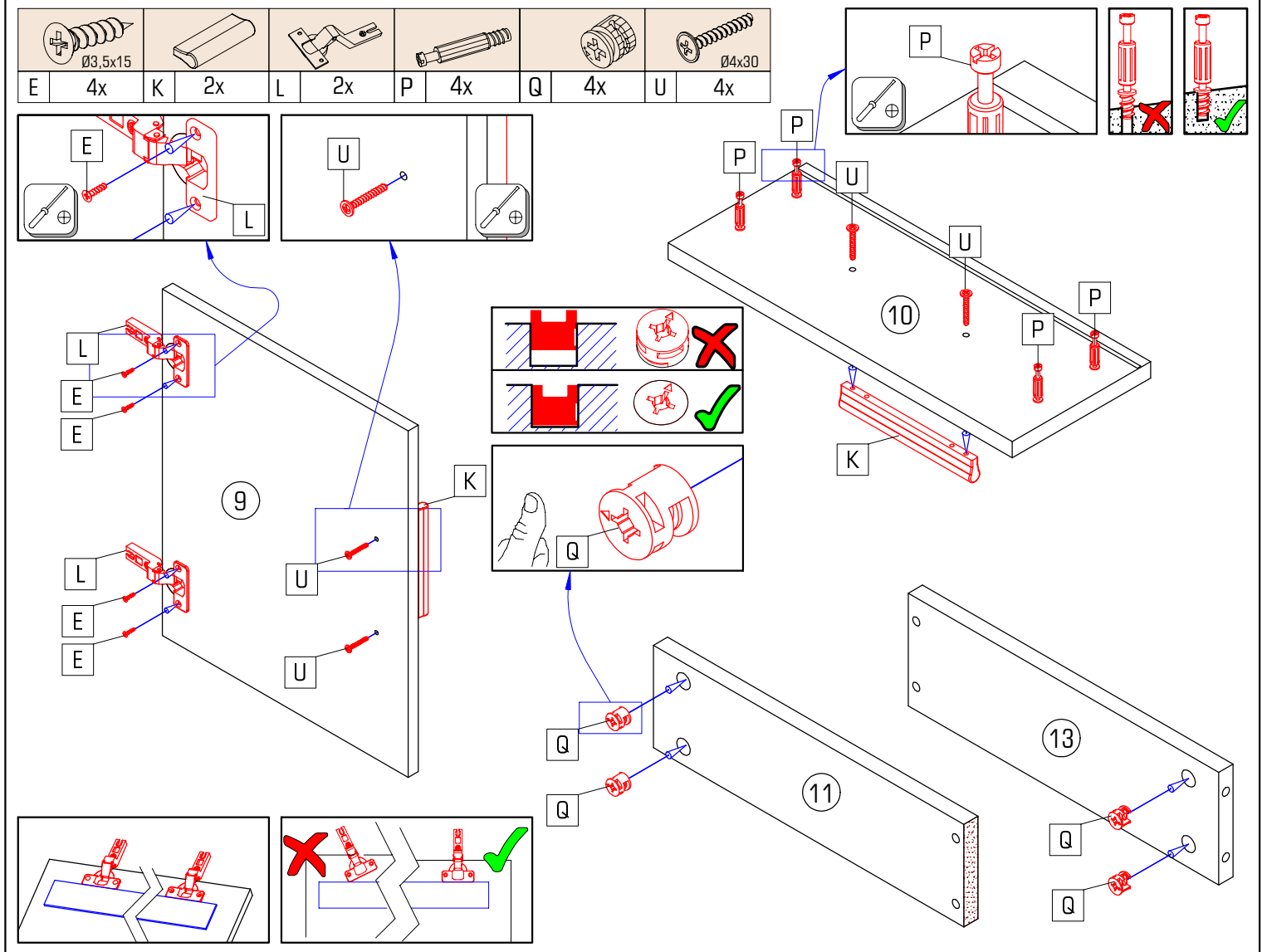



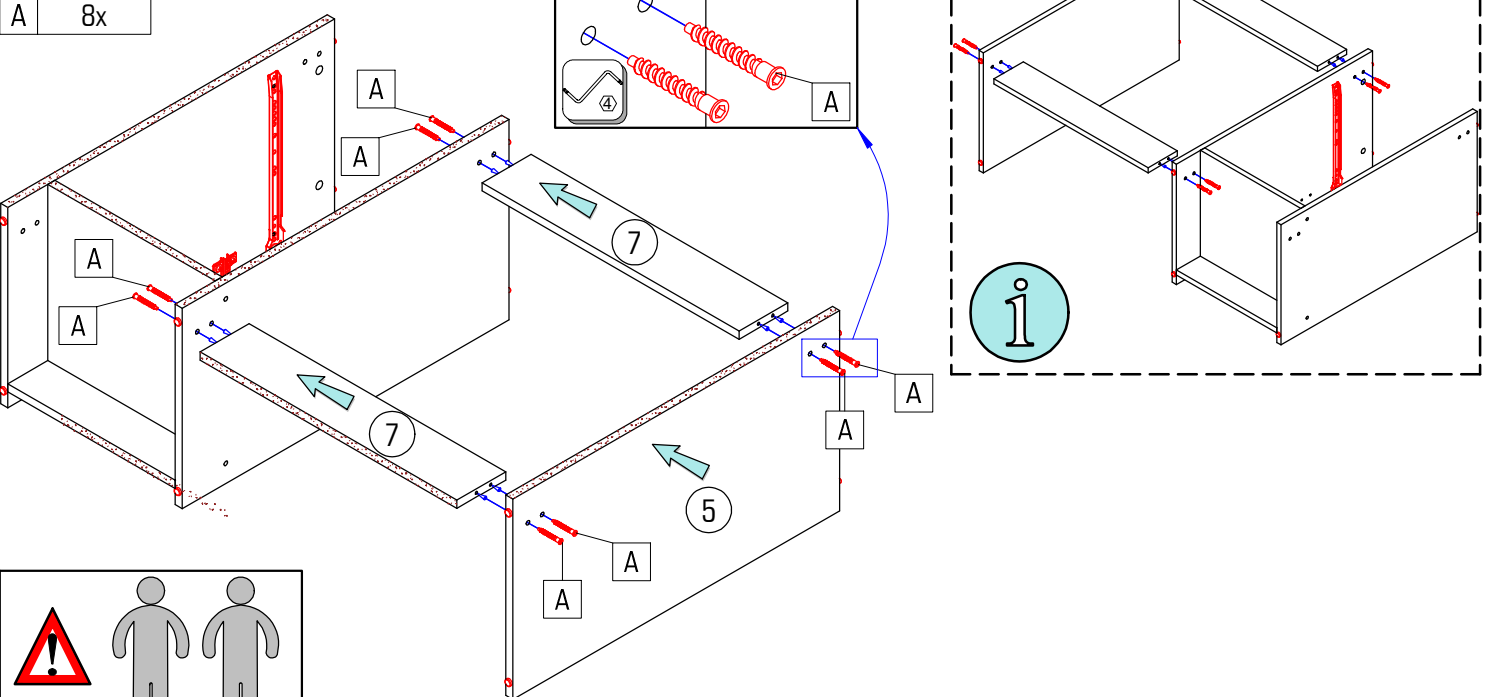

# 4/6 SIRISS NEW

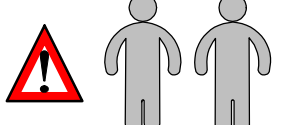
	Ø7x50
A	8x



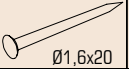



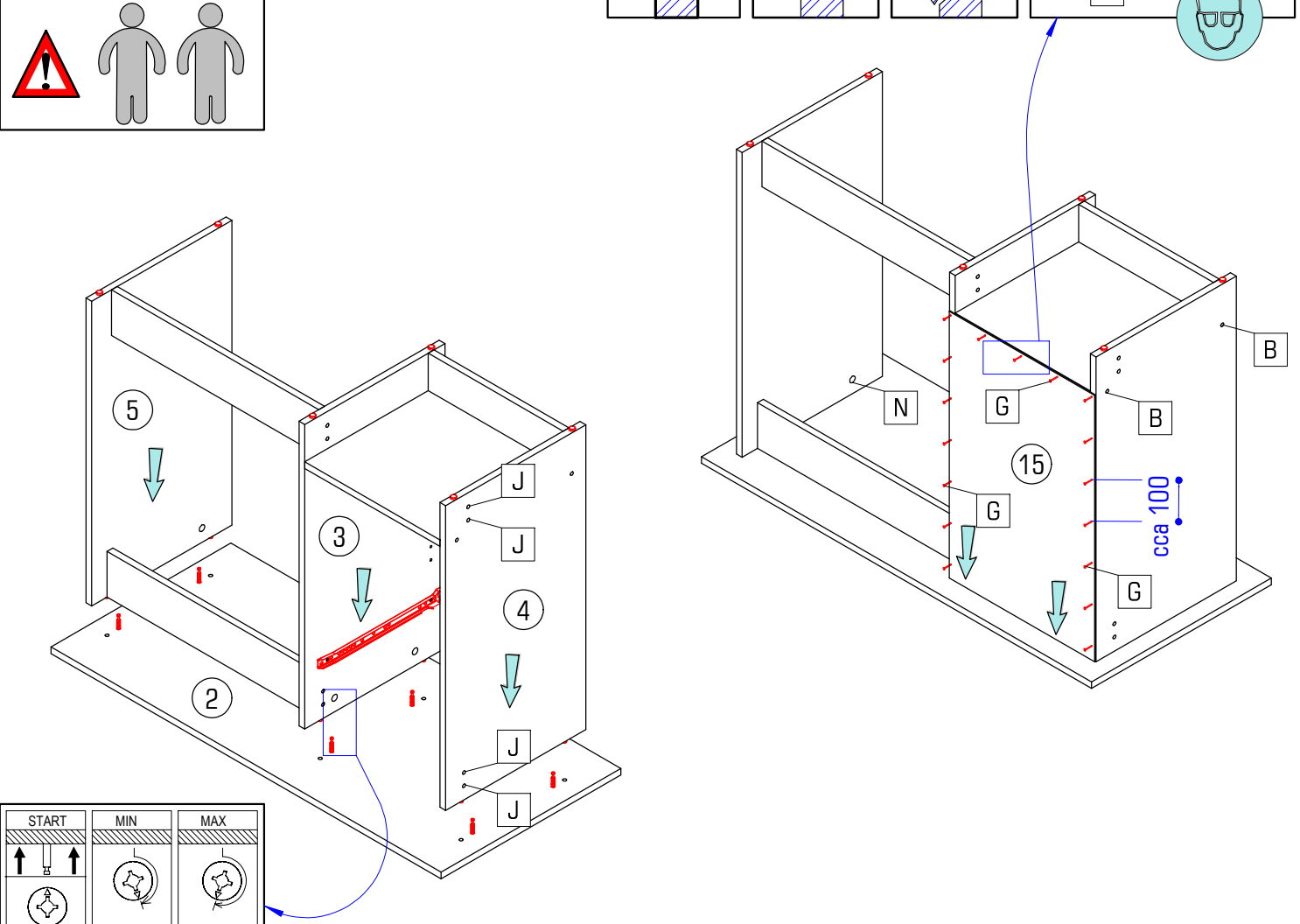

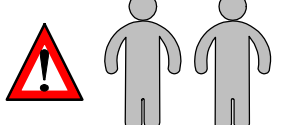

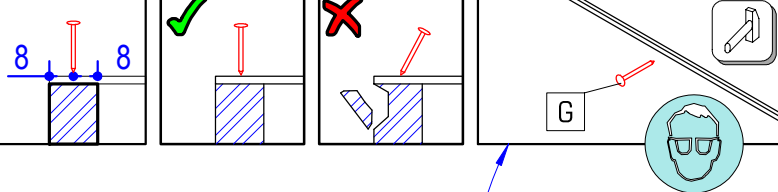



	2x		Ø1,6x20		4x		2x
B	2x	G	25x	J	4x	N	2x





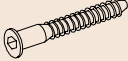

START	MIN	MAX
		
		

				
A	E	H	N	T
4x	6x	1x	4x	3x
	Ø3,5x15	L=350		Ø3,5x16

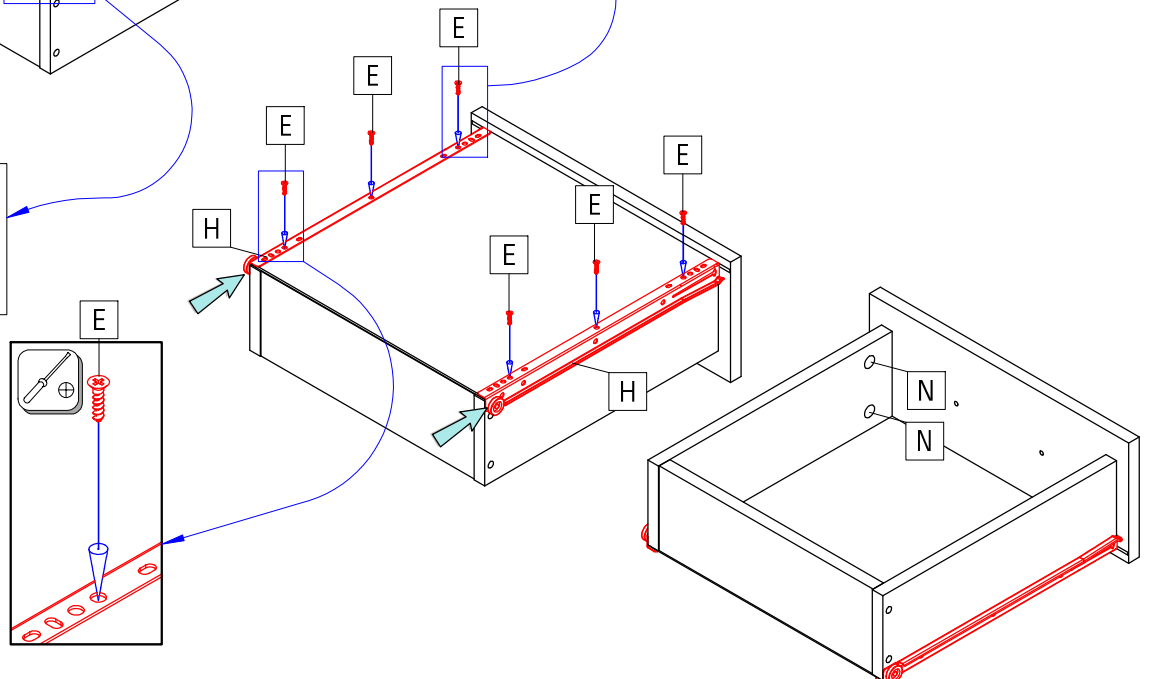
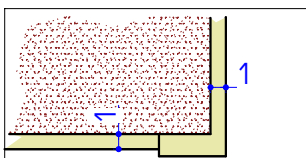
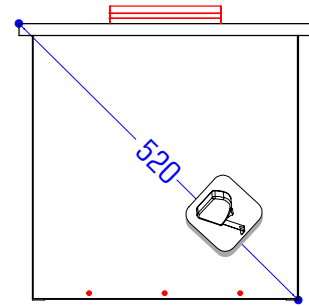
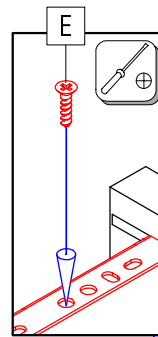
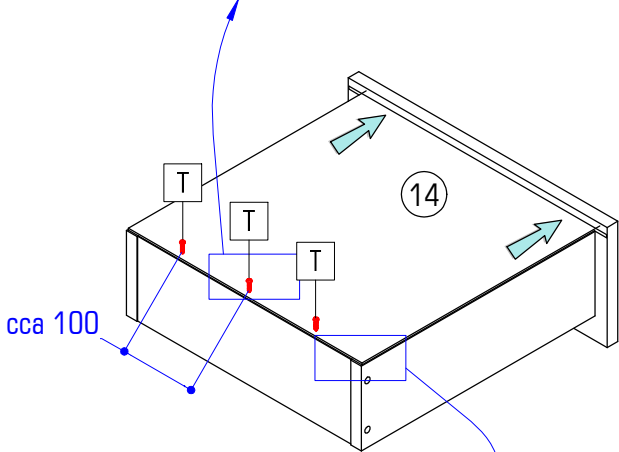
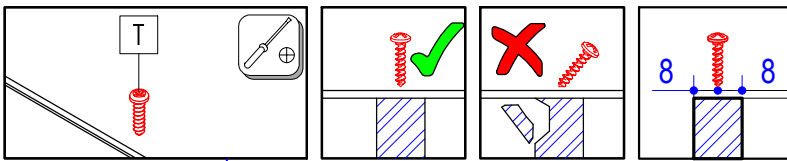
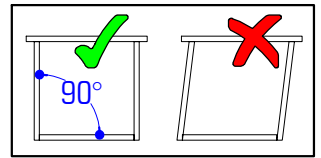
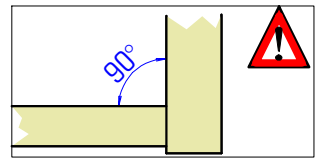
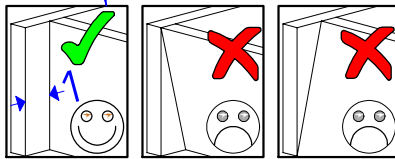
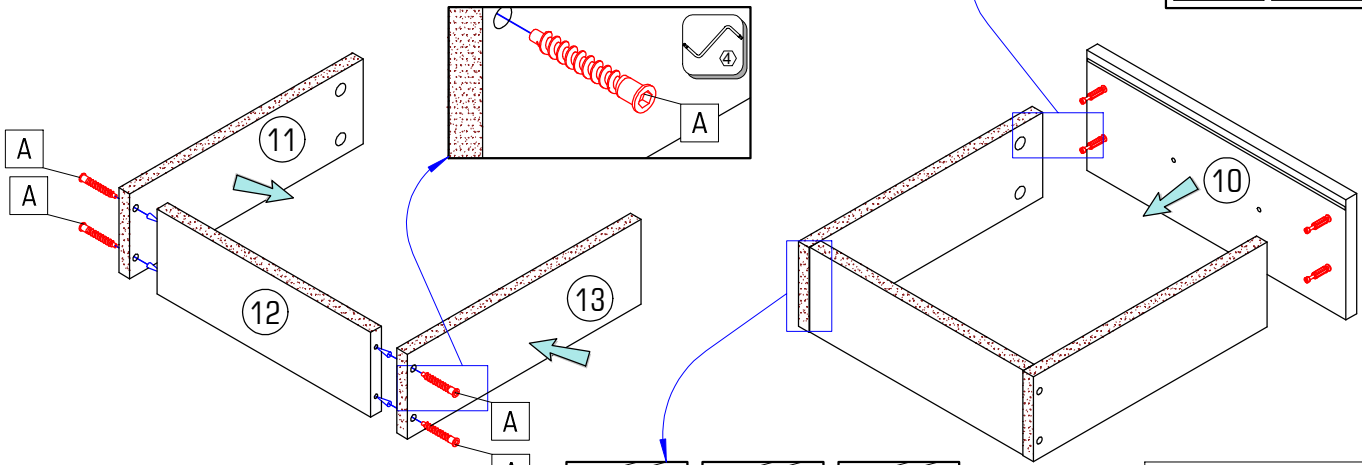
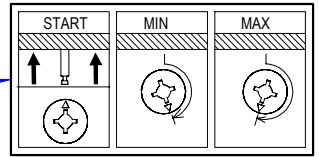

# 6/6 SIRISS NEW

B 6x

35 kg

B

9

B

B

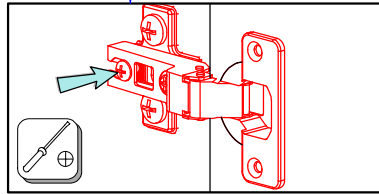
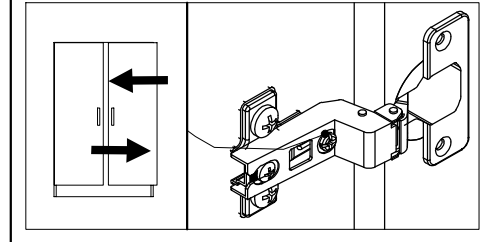
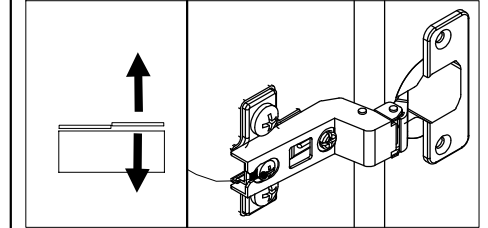
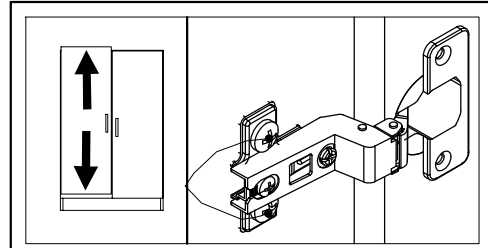
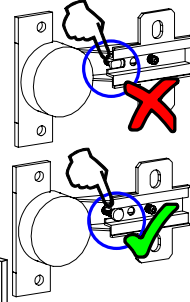

P

5 kg

10

\*L

5 kg

10

