







# 2/8 KLAUDIUS TYP 8

			
Ø8x30	Ø15x13	Ø50 v=27	
L 24x	U 12x	N 5x	V 12x



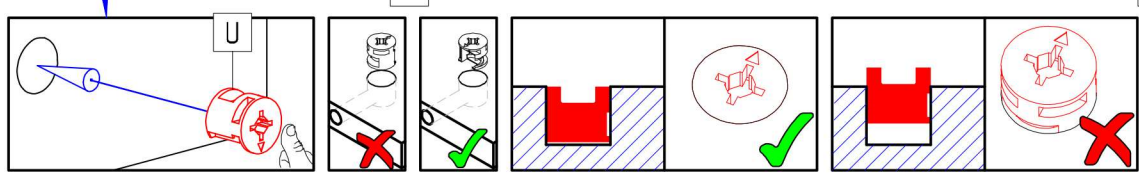
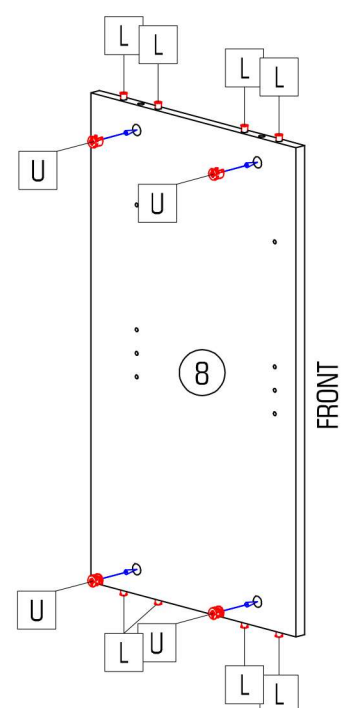
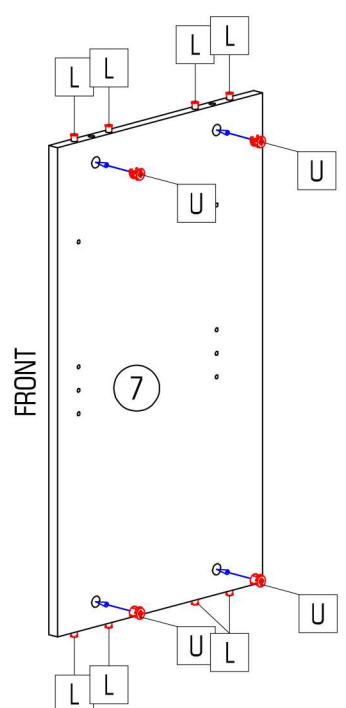
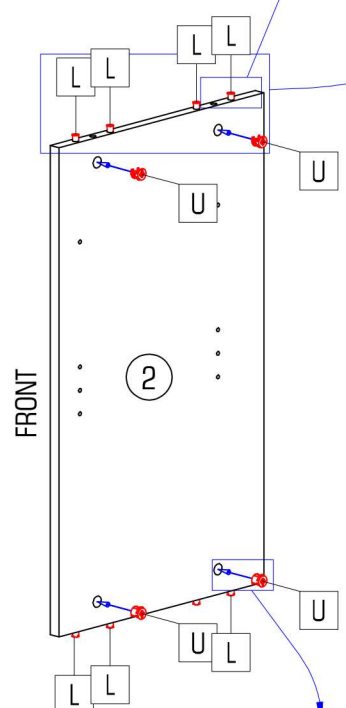
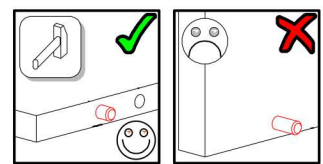
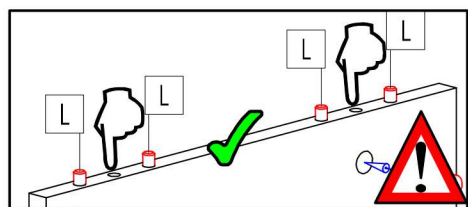
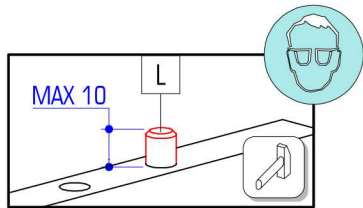
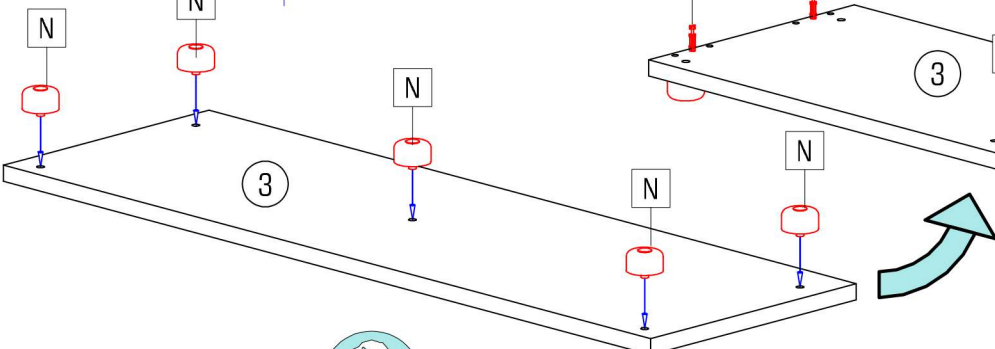
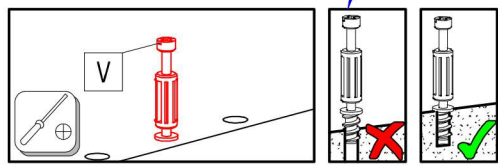
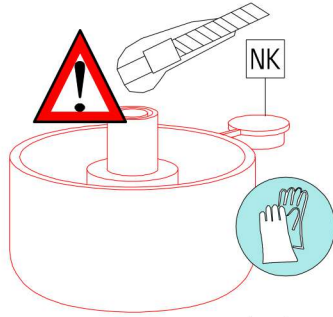
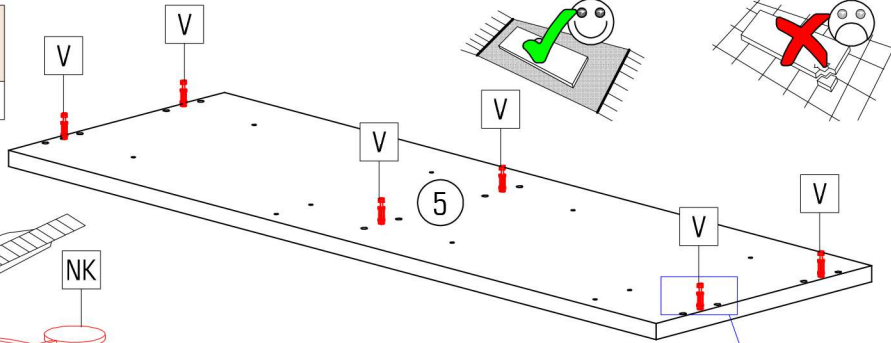
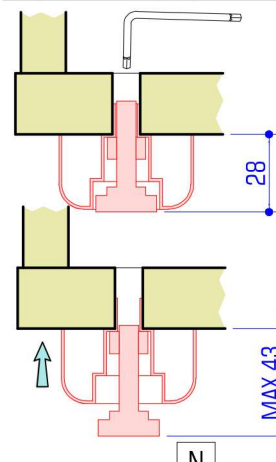
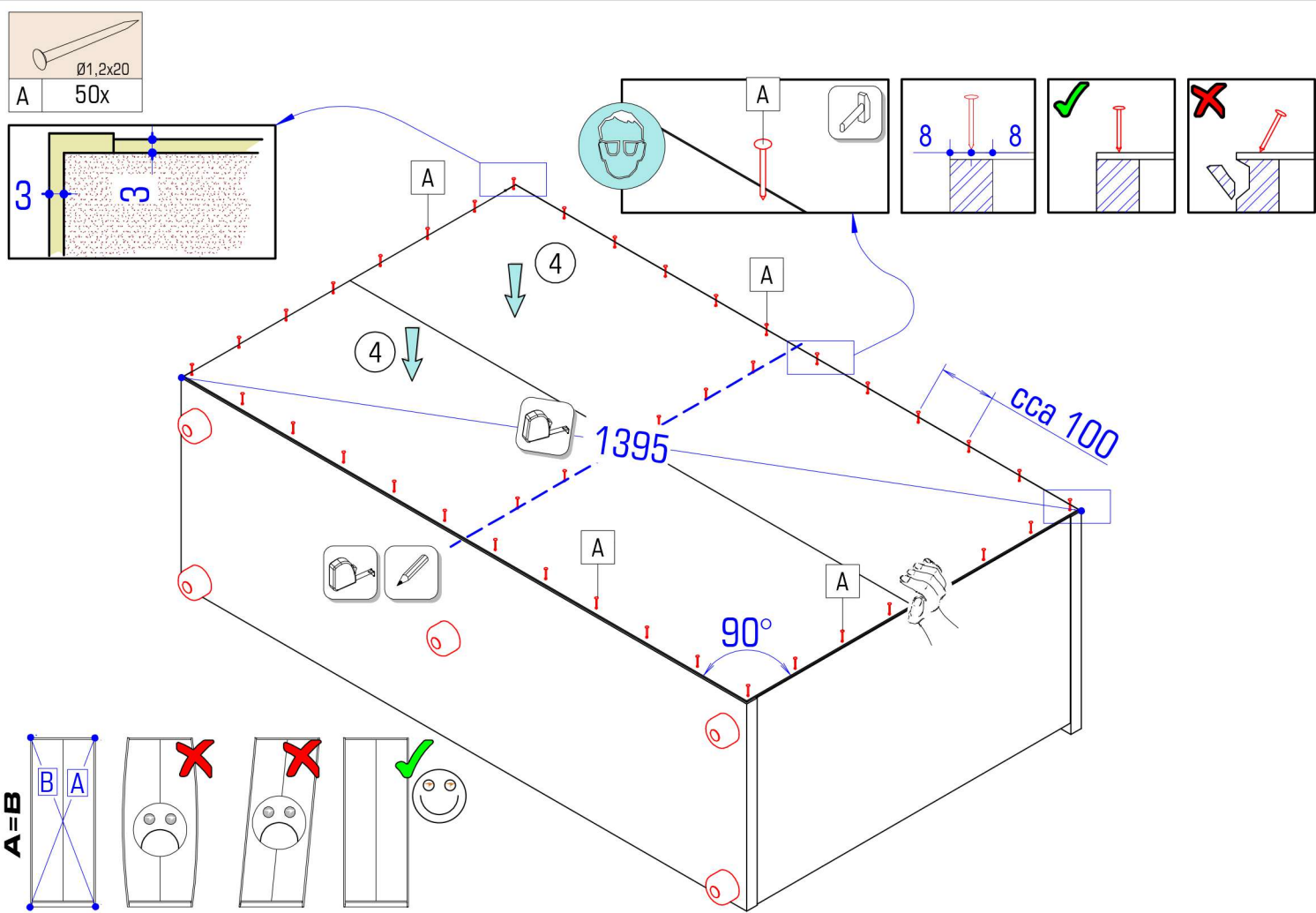
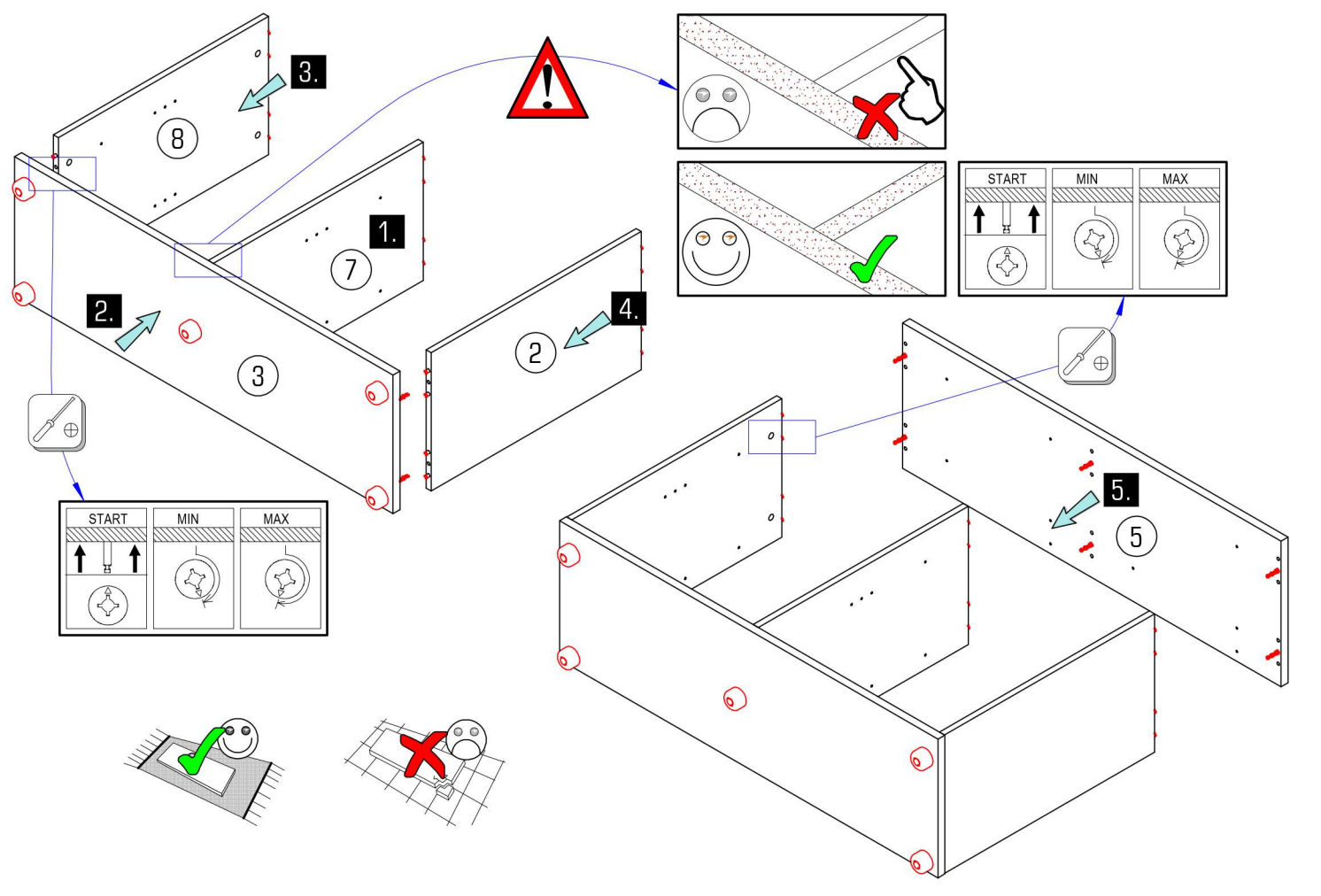



# KLAUDIUS TYP 8 5/8

		$\varnothing 8$
D	8x	F 2x

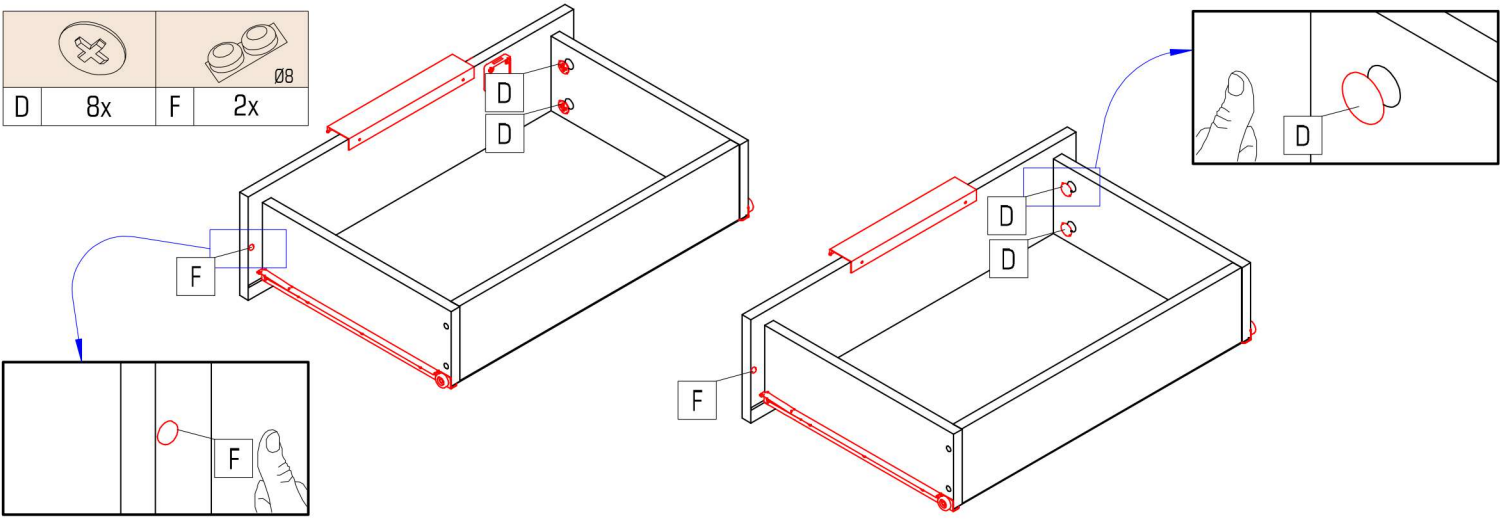

P	4x	T 4x	X 8x	Y3 1x	Y4 2x
				Z1 2x	

**\*L\***

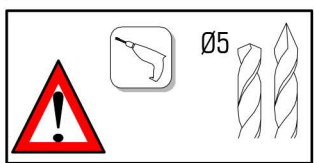
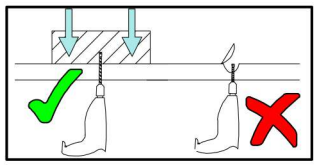
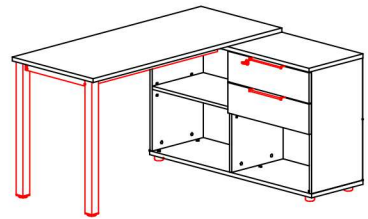

**\*R\***

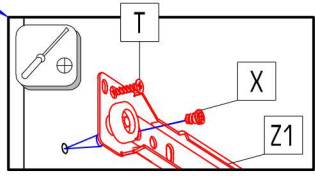
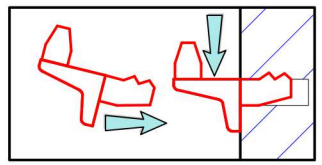
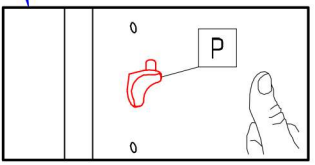
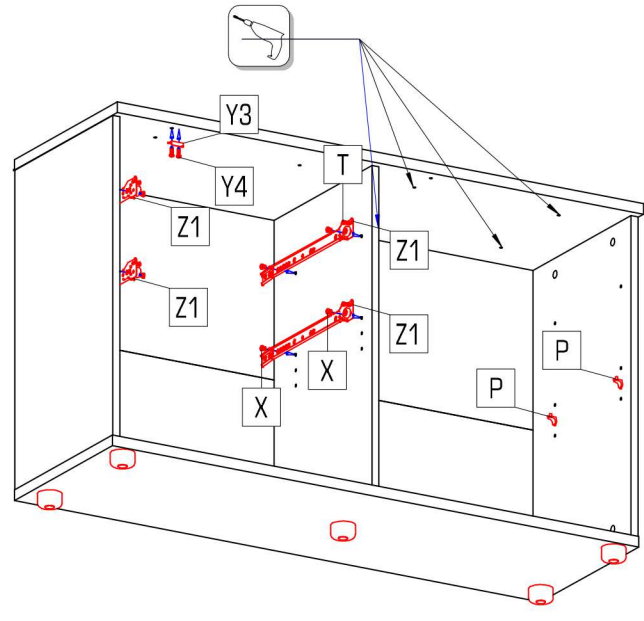
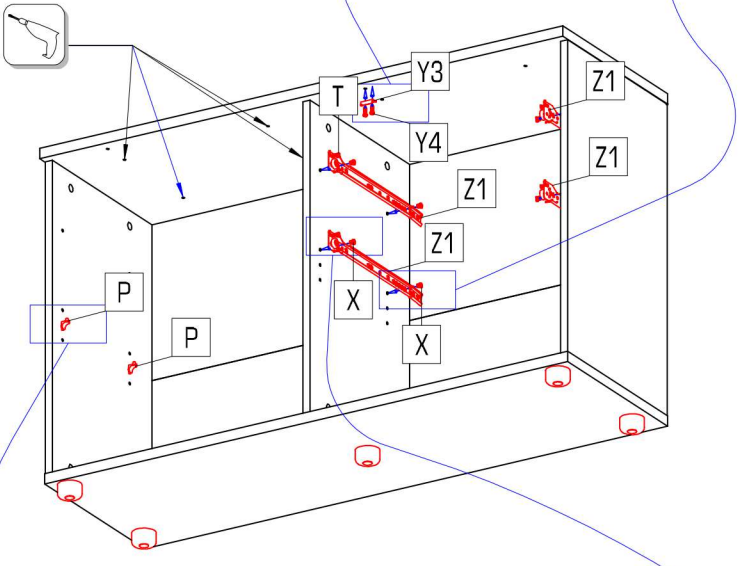
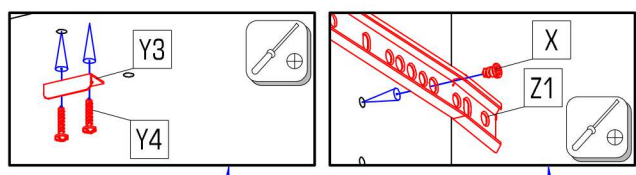
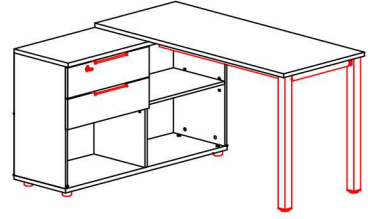





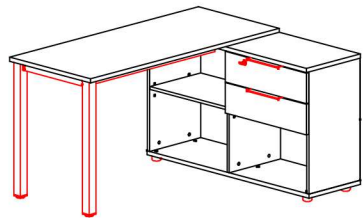

# 6/8 KLAUDIUS TYP 8

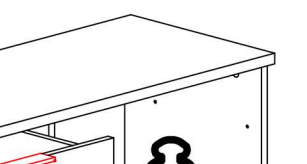
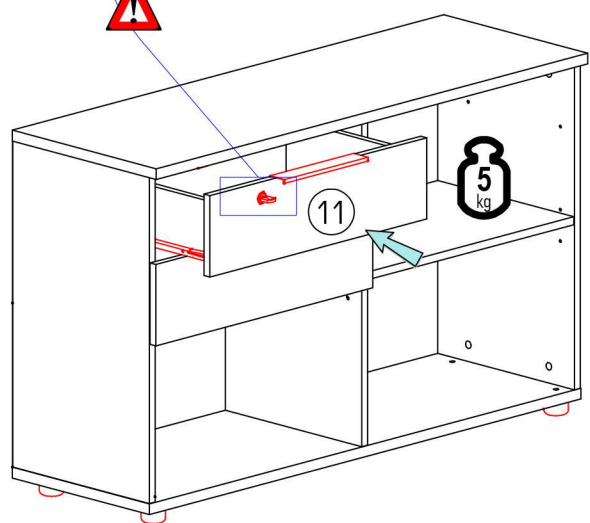
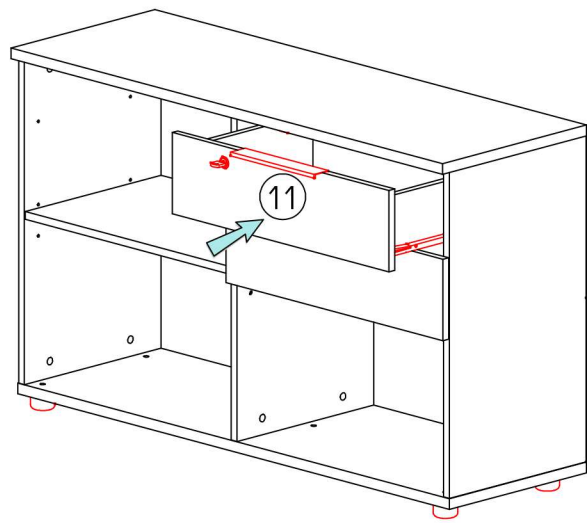
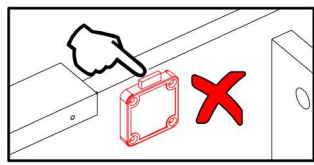
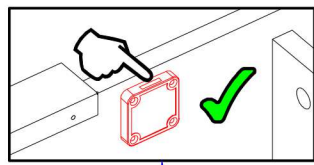
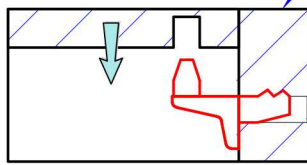
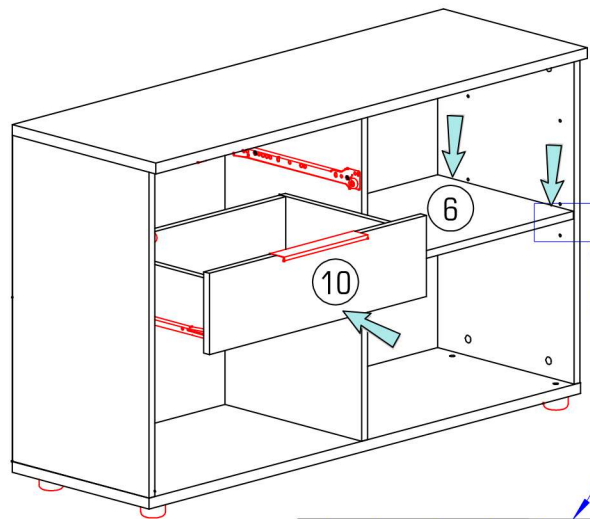
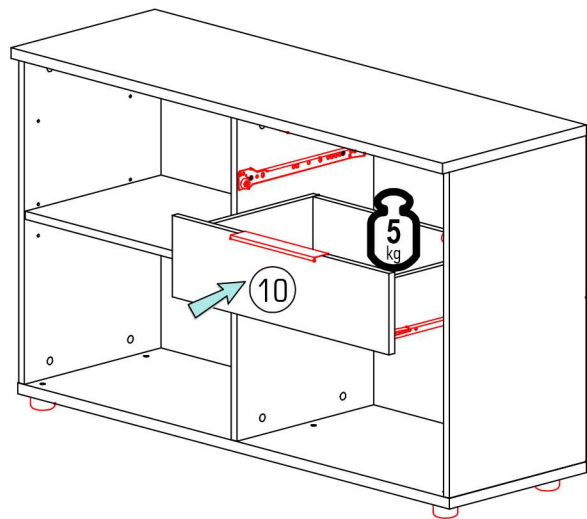
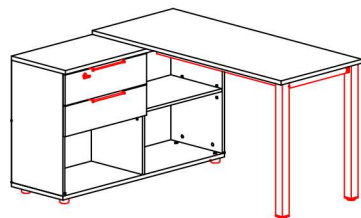
\*L\*



\*R\*



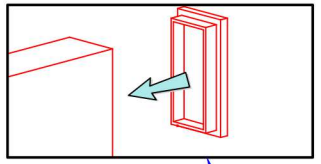
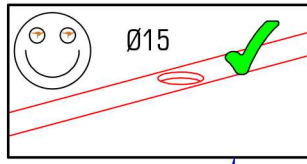
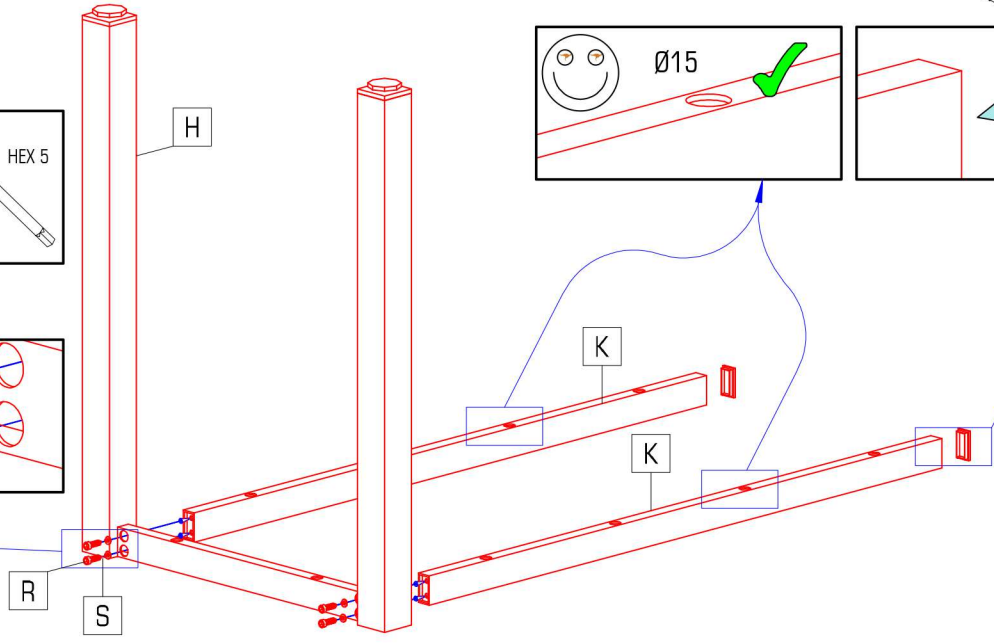
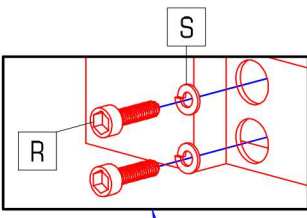
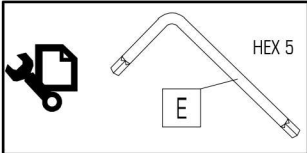
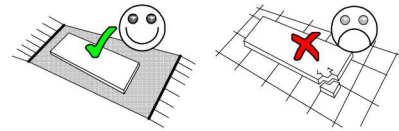

									
H	1x	K	2x	M	2x	R	4x	S	4x
		L=950				M6x15 H5			



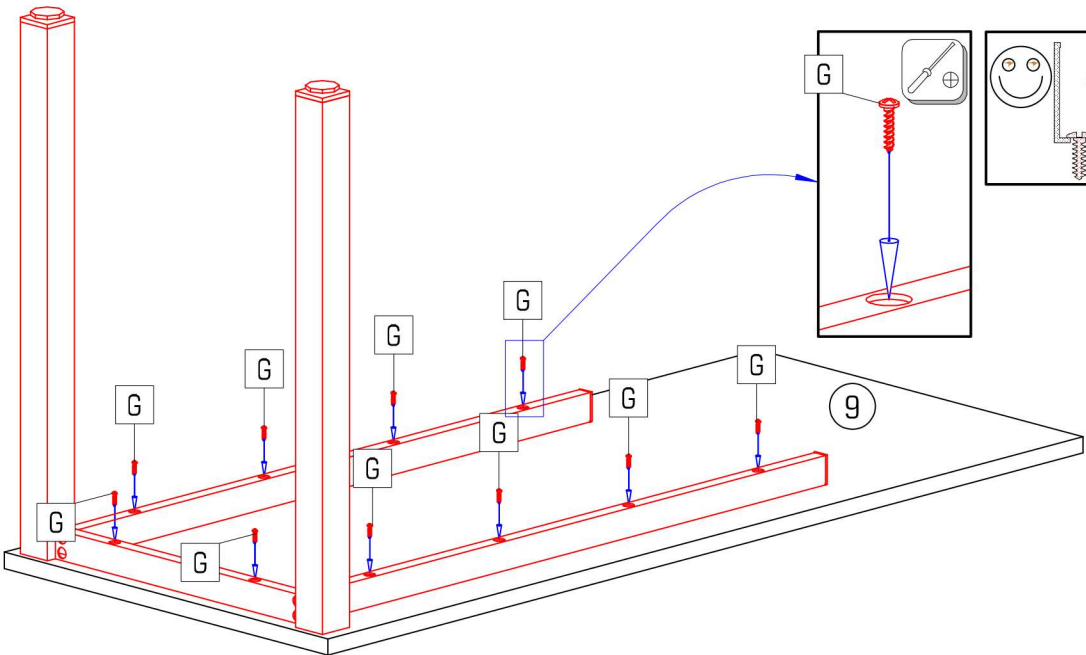
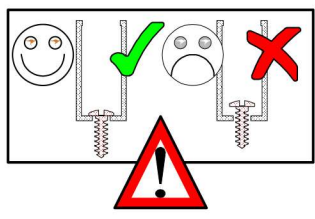
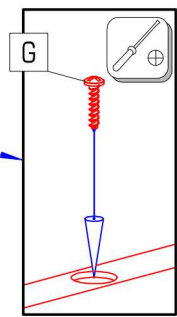
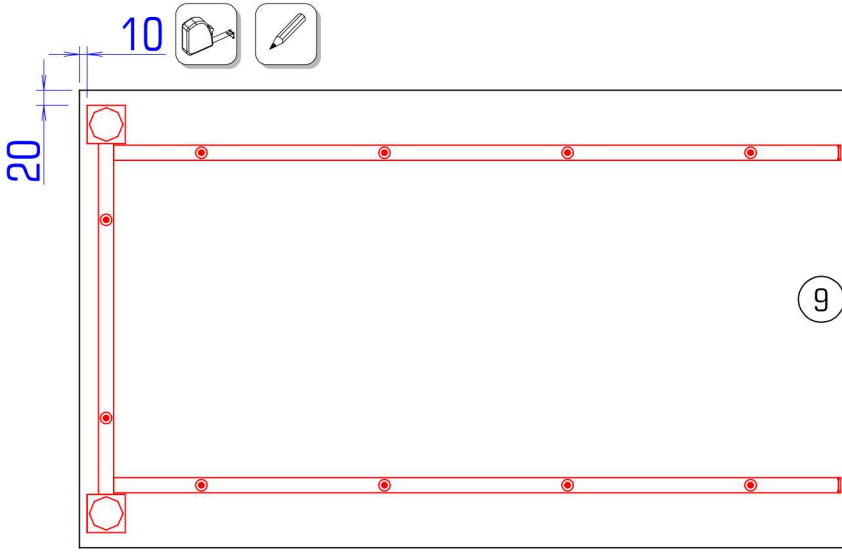

Ø5,0x16
G 16x

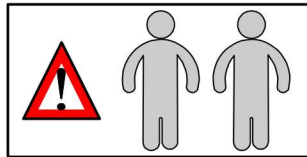

# 8/8 KLAUDIUS TYP 8

	$\varnothing 4,0 \times 40$		$\varnothing 15$
B	4x	J	4x



**\*L\***

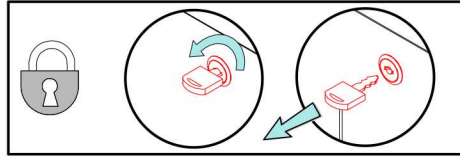
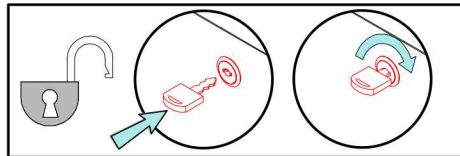
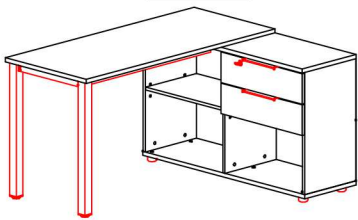

**\*R\***

