

KLAUDIUS TYP2

Art.-Nr.

394 622
394 614

700
1964
400
[mm]

1/7
v0
17-2024

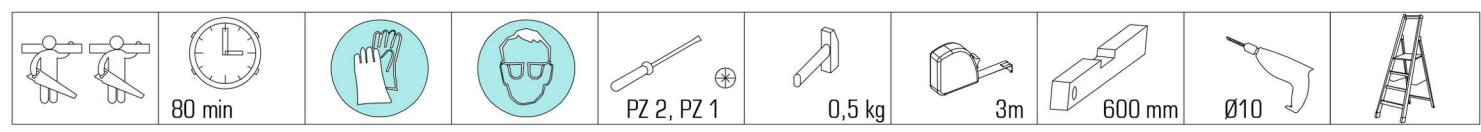

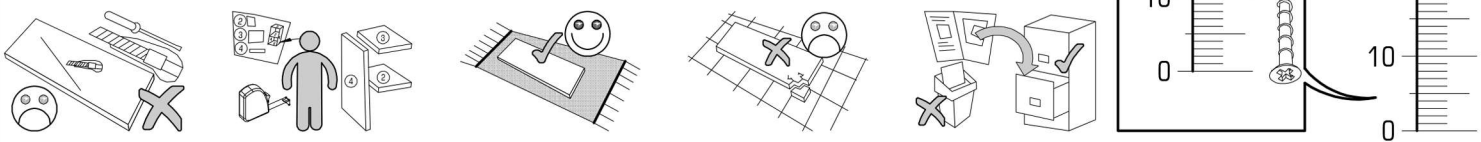
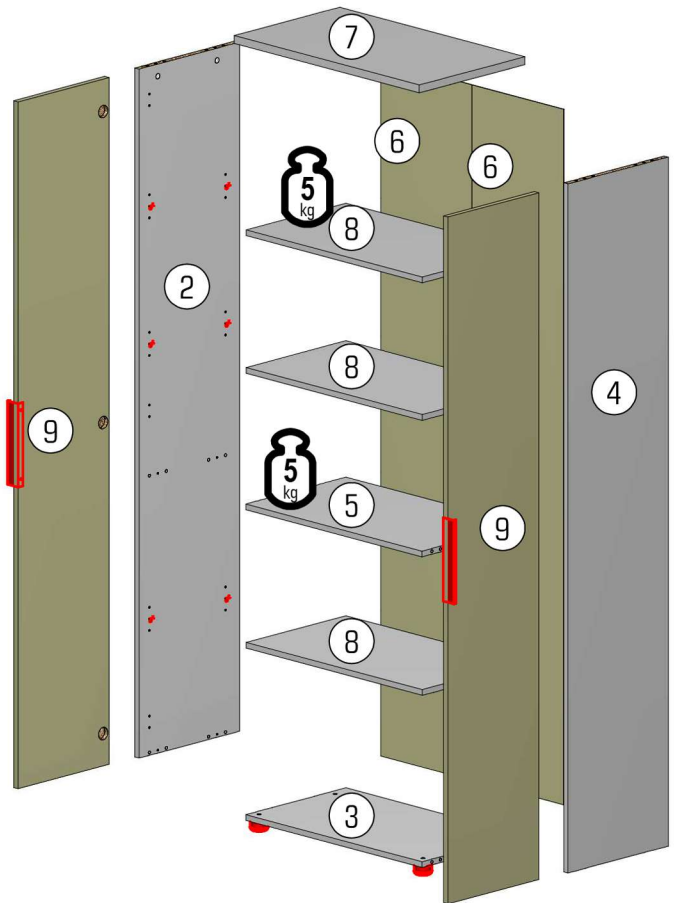
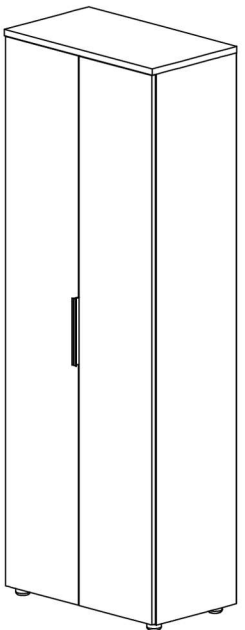

ID	ID			
21100	②	1914*380*16	1x	1/3
21101	③	666*379*16	1x	2/3
21102	④	1914*380*16	1x	1/3
21103	⑤	666*379*16	1x	2/3
21086	⑥	346*1932*3	2x	1/3
21087	⑦	700*400*22	1x	2/3
21104	⑧	666*378*16	3x	2/3
21105	⑨	344*1908*16	2x	3/3



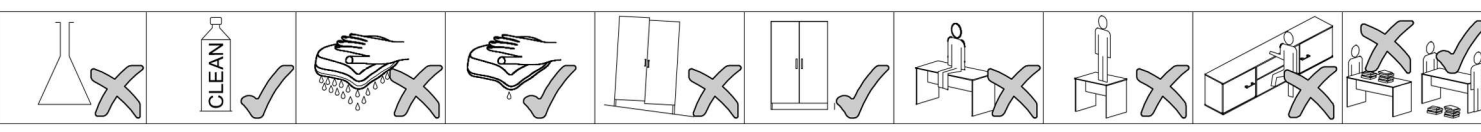





8402.03		Ø8	22256.00		Ø5,0x70	22234.00		Ø3,0x12	22243.00		Ø3,5x15	22244.01		Ø3,5x16	34956.00		22800.01		4	21102.00		Ø1,6x20	24101.00		Ø10	
A	2x		B	1x		C	4x		D	12x		E	2x		F	8x	G	1x		H	75x		K	1x		
27000.00		Ø8x30	8501.00			30082.01		Ø50 v=27	31103.00			32246.00		L=230	70013.01		Ø15x13	70021.01			36002.07			36002.07		
L	24x		M	12x		N	4x		P	1x		Q	2x		U	12x		V	12x		X	6x		Y	6x	

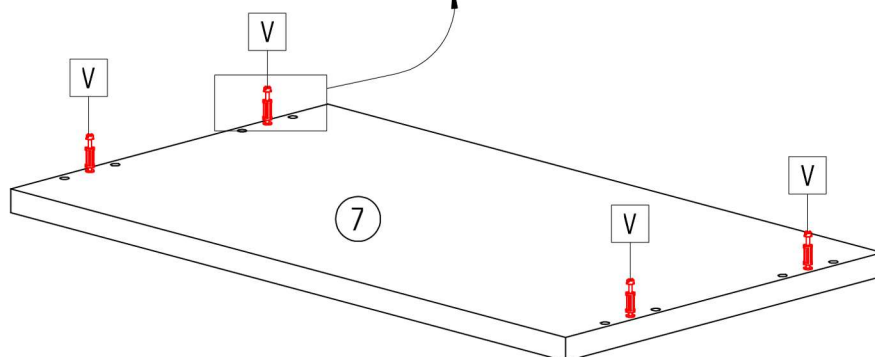
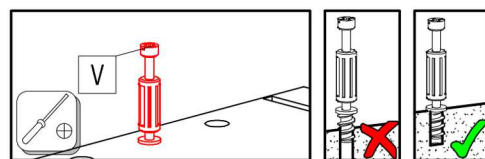
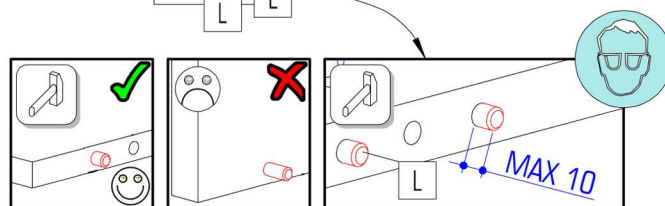
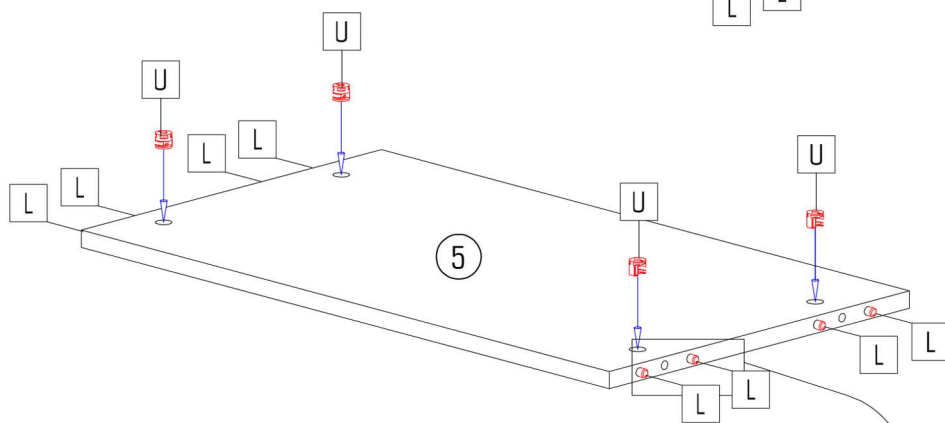
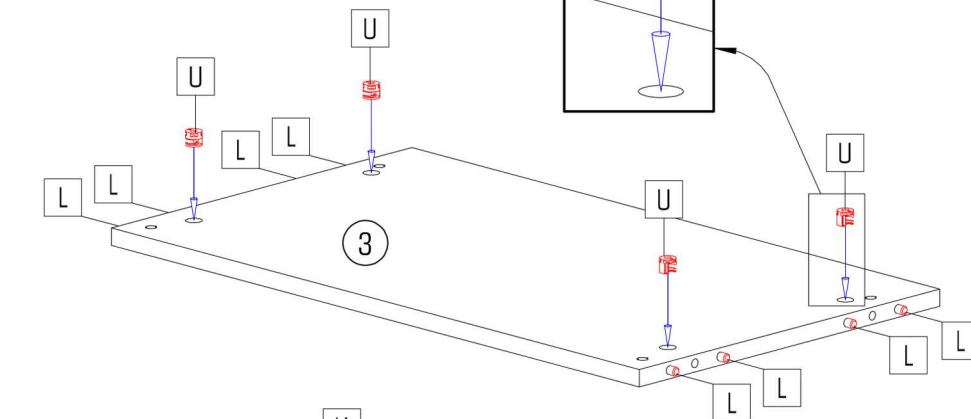
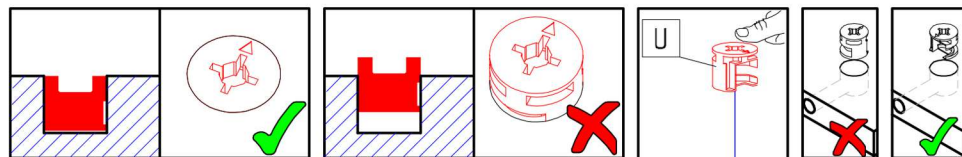
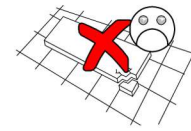

2/7 KLAUDIUS TYP2

	Ø8x30		Ø15x13	
L	16x	U	8x	V
				4x

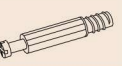

				
L 8x	M 12x	U 4x	V 8x	Y 6x

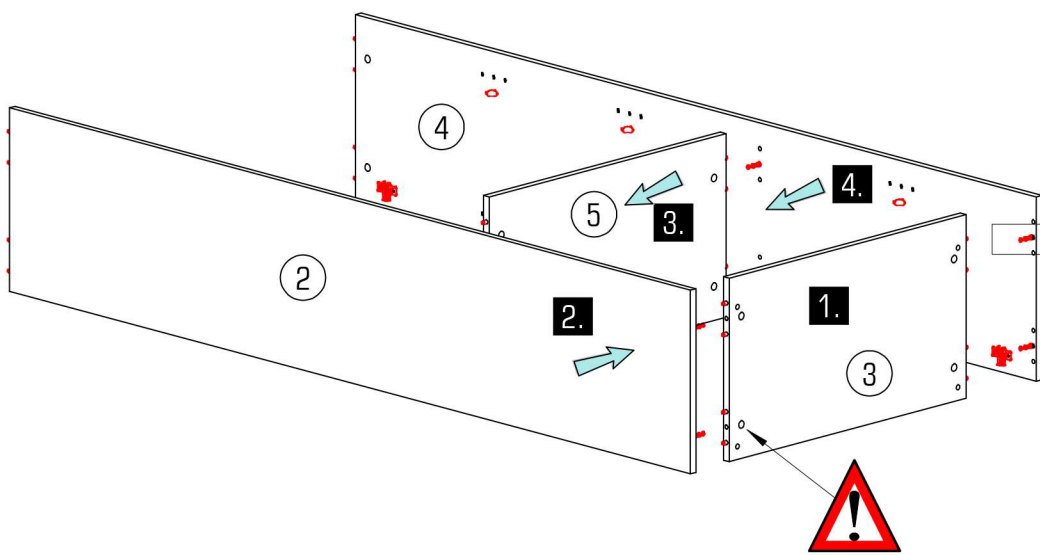
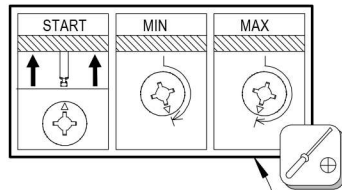
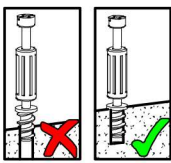
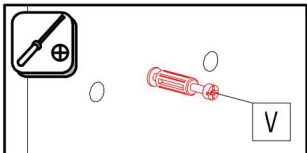
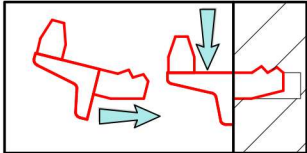
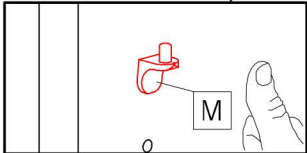
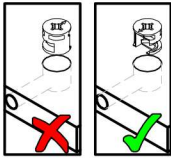
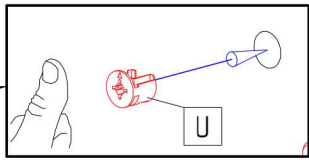
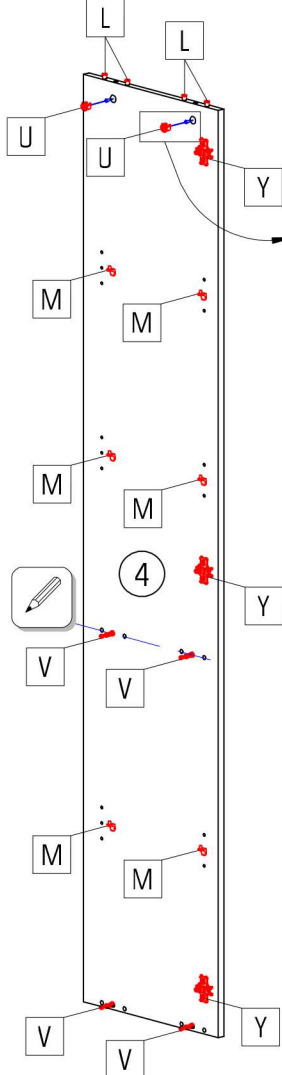
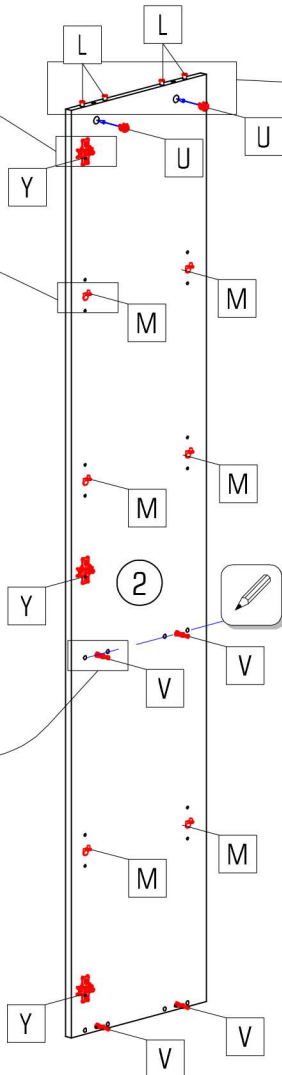
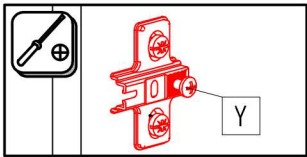
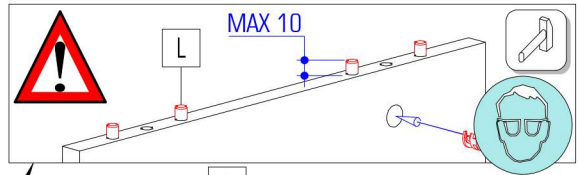



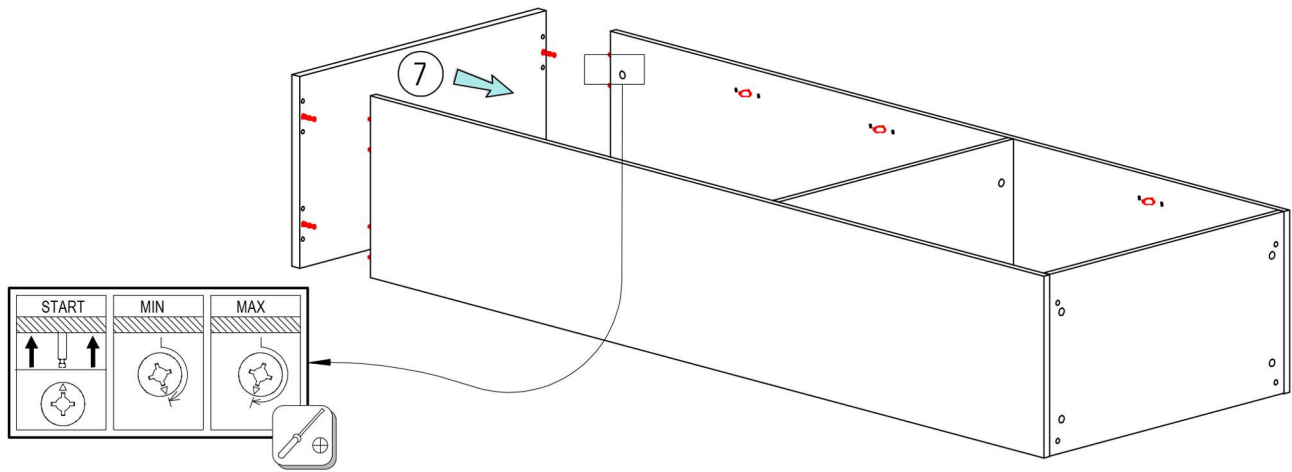

4/7 KLAUDIUS TYP2

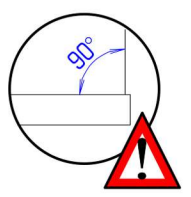
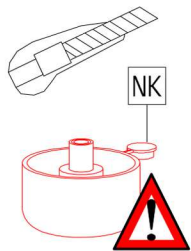
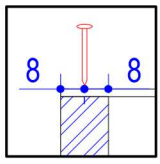
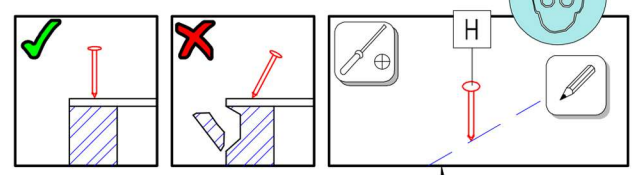
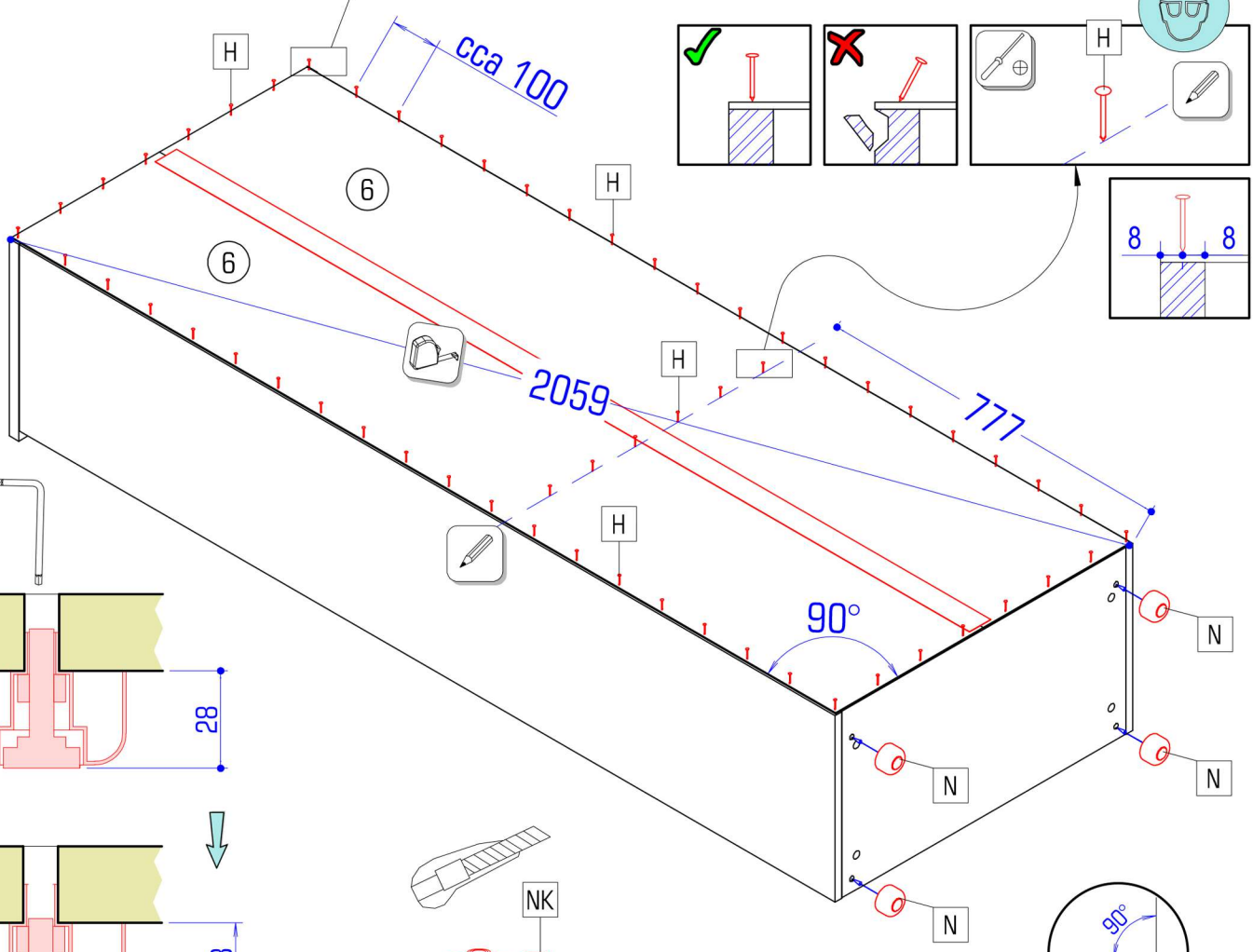
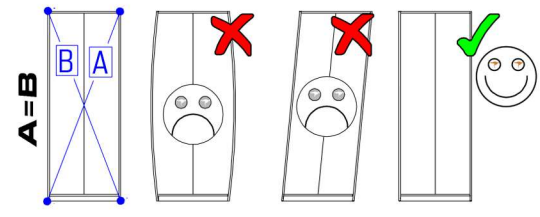
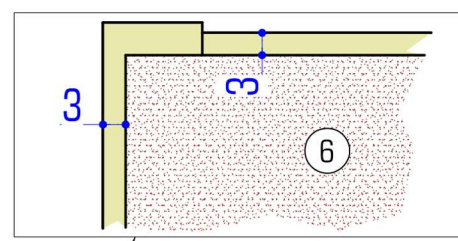
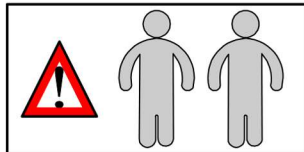

Ø1,6x20	Ø50 v=27
H 75x	N 4x



			
Ø5,0x50	Ø3,5x16	Ø10	
B 1x	E 2x	K 1x	P 1x

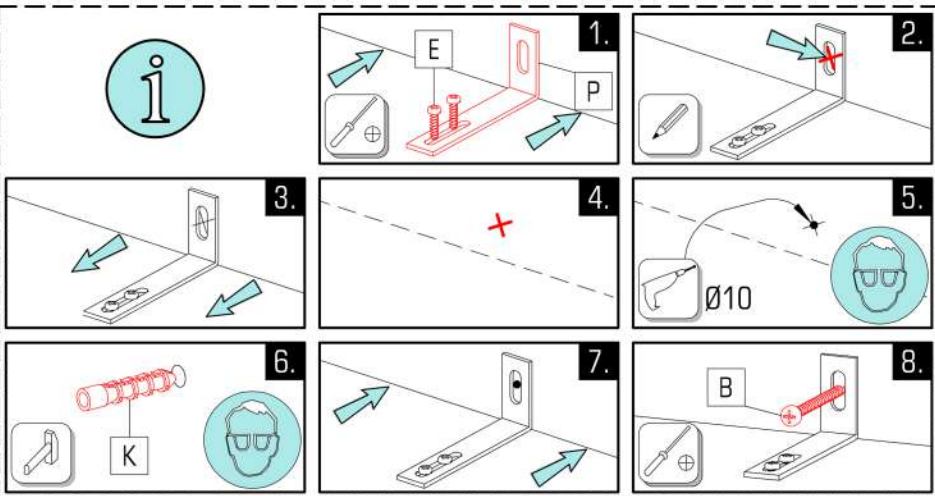

Prudență! Zidul trebuie examinat înainte de asamblare prizele de perete sunt adecvatenumai pentru utilizarea în zidărie fermă, cum ar fi betonul bloc sau cărămidă. Nu folosiți zidăria zidurilor de perete, cum ar fi cărămidă goală, blocul ușor, suprafețe cum ar fi gips-carton sau altă încadrare sisteme. Dacă este cazul, trebuie folosite anume prize de perete! Acestea sunt disponibile în un magazin specializat (magazin de hardware) . În caz de nerespectare, producătorul / vânzătorul cu amănuntul sau importatorul nu își asumă răspunderea.

Caution! The wall must be examined before assembly The included universal wall plugs are only suitable for using in firm masonry such as concrete block or brick. Do not using the wall plugs masonry such as hollow brick, lightweight block, surfaces such as gypsum plasterboard or other framing systems. If applicable, particular wall plugs must be used! These are available at a specialised store (hardware store).In case of non-compliance, the manufacturer/retailer or importer do not assume liability.

Upozornenie! Pevnosť steny sa musí pred montážou bezpodmienečne skontrolovať. Priložené univerzálne hmoždenky používajte jedine pre pevné murivo ako je betón/tehla. Hmoždenky sa nesmú používať v prípade ľahkého stavebného muriva, dutá tehla, Sádrokartónová doska, alebo iných konštrukcií rámu. U týchto stien je nutné použiť špeciálne hmoždenky! Tieto je možné dostať v špeciálnych predajniach so stavebným materiálom. Pri nedodržíaní pokynov nepreberajú výrobcovia/predajci a dodávateľa zodpovednosť za vzniknuté škody.

Upozornění! Před montáží je nutné zkontrolovat stav stěny. Priložené univerzální hmoždinky jsou určeny pouze k použití pro pevné zdivo jako beton/cihly. Hmoždinky do zdi se nesmí používat u dutinová cihla, zdívka jako porovity stavební kámen, sádrokartónová deska nebo jiný měkký materiál. U těchto zdví jsou nutné použít speciální hmoždinky! Jsou k dostání v speciálních prodejních se stavebním materiálem. Při nedodržení těchto pokynů výrobce/prodeje a dovozce neručí za způsobené škody.

Paznja! Prije montaže obvezno provjerite svojstvo zida. Priložene univerzalne tiplje namijenjene su isključivo za masivne zidove od betona/opeke. Tiplje za masivne zidove ne smiju se koristiti za zidove kao npr šupljina opeka laki sastavni elementi, gips-kartonske ploče ili drugi modularni načini gradnje. Za te zidove potrebne su eventualno specijalne tiplje! Iste su dostupne u specijaliziranim trgovinama građevinskim materijalom. U slučaju nepridržavanja prethodno navedenih napomena, proizvođač/trgovac i uvoznik ne preuzimaju odgovornost!

Achtung! Die Wandbeschaffenheit ist vor der Montage unbedingt zu prüfen. Die beigelegten Universaldübel sind ausschließlich nur zur Verwendung für festes Mauerwerk wie Beton/Ziegel. Die Mauerdübel dürfen nicht bei Mauerwerk wie Hohlraumziegel, Leichtbausteinen, Gipskartonplatte oder anderer Rahmenbauweise verwendet werden. Bei diesen Mauerwerken sind gegebenenfalls Spezialdübel zu verwenden! Diese sind in einem Fachgeschäft erhältlich. Bei Nichteinhaltung wird seitens Produzenten/Händler und Importeur keine Haftung übernommen.

Vigyázat! Szerelés előtt a falfelületet feltétlenül vizsgálja meg. A mellékelt univerzális tiplik kizárólag stabil falazathoz használható mint például beton/tégla. A fali tiplik nem használható könnyű építőkövekhez, üreg tégla, gipszkarton lapokhoz vagy más fávázás építményekhez. Ezekhez a falfelületekhez csak speciális tiplik használhatóak, melyek szaküzletekben (barkácsárúházakban) beszerezhetőek. Fentiek figyelmen kívül hagyása esetén a gyártó/kereskedő vagy forgalmazó nem vállal felelősséget.

OBS! Väggens sammansättning ska absolut kontrolleras innan montering. De bifogade pluggarna får endast användas för stabila och fasta väggar, som tex. betong/tegel. De får absolut inte användas för kavitet tegel, väggar ur fonolit, gipskivor eller dylikt. För dessa väggar måste det användas speciella pluggar, som finns att köpa i specialiserad handel (byggmarknad). Varken tillverkare, handlare eller importör övertar ansvar, om dessa anvisningar inte följs.



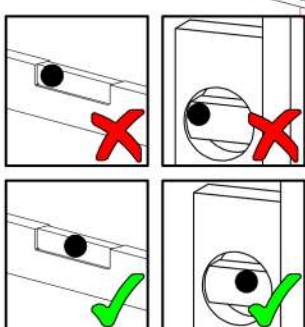
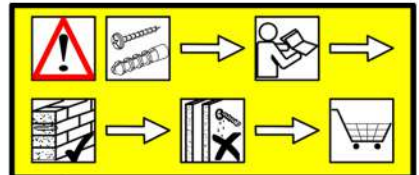
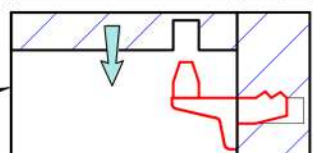
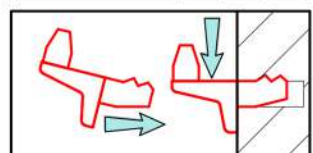
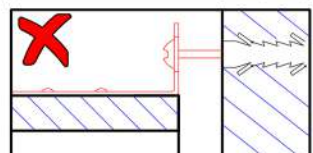
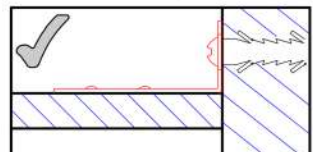
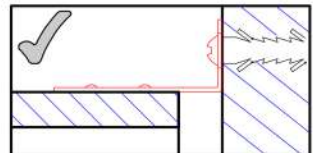
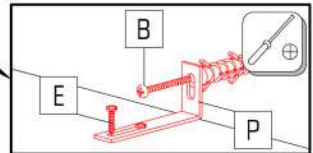
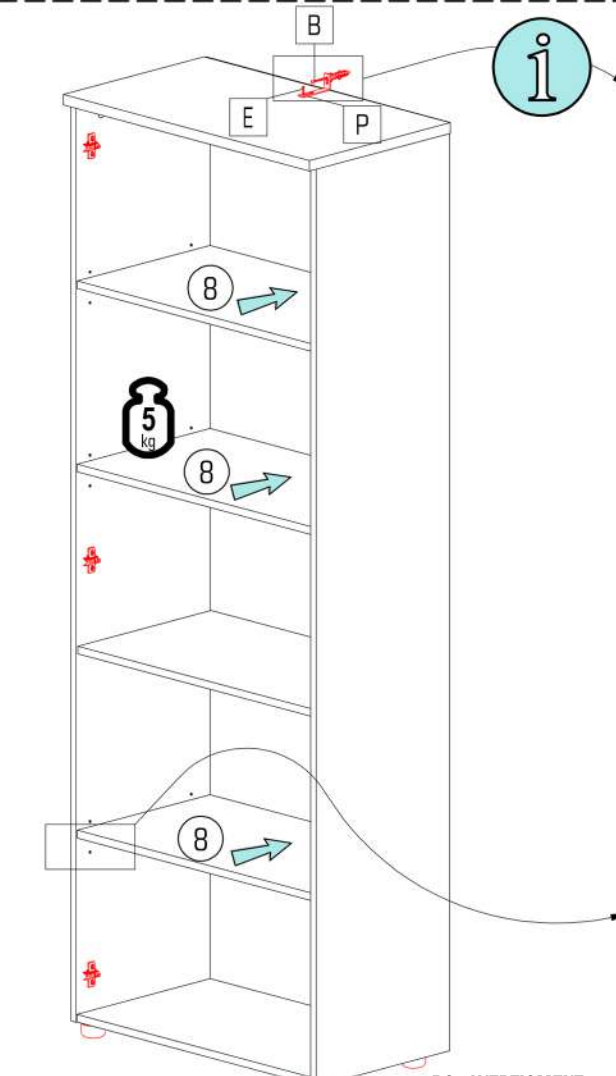

Pozor! Pred montažo proverite stanje stene. Priloženi univerzalni mozniki so izključno samo za uporabo na čvrstem zidovju, kot sta beton in opeka. Stenski mozniki se ne smejo uporabljati pri zidovju kot so votline opeke, zidaki za lahko gradnjo, mavčne plošče ali druge okvirne gradnje. Pri teh zidovjih morate v danih primerih uporabljati posebne moznike. Ti so na voljo v specializiranih trgovinah (trgovinah z gradbenim materialom) Pri upoštevanju se s strani proizvajalca/trgovca in uvoznika ne prevzame jamstvo.

Uwaga! Ścianę należy sprawdzić przed montażem. Dołączone uniwersalne kołki rozporowe są odpowiednie tylko do stosowania w mocnych murach, takich jak beton lub cegła. Nie rób za pomocą kołków rozporowych murowanych, takich jak pustak, lekka kostka, powierzchnie takie jak płyty gipsowo-kartonowe lub inne systemy ram. Jeśli dotyczy, muszą to być określone kołki rozporowe być użytym! Są one dostępne w specjalistycznym sklepie niezgodność, producent / sprzedawca lub importer nie ponoszą odpowiedzialności.

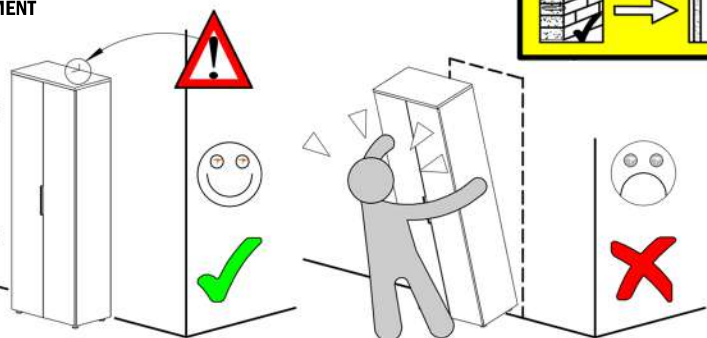



RO AVERTISMENT
 EN WARNING
 SK VÝSTRAHA
 CZ VAROVÁNÍ
 HR UPOZORENIE
 DE WARNUNG
 HU FIGYELEM
 SE VARNING
 SI OPOZORILO
 PL OSTRZEŻENIE

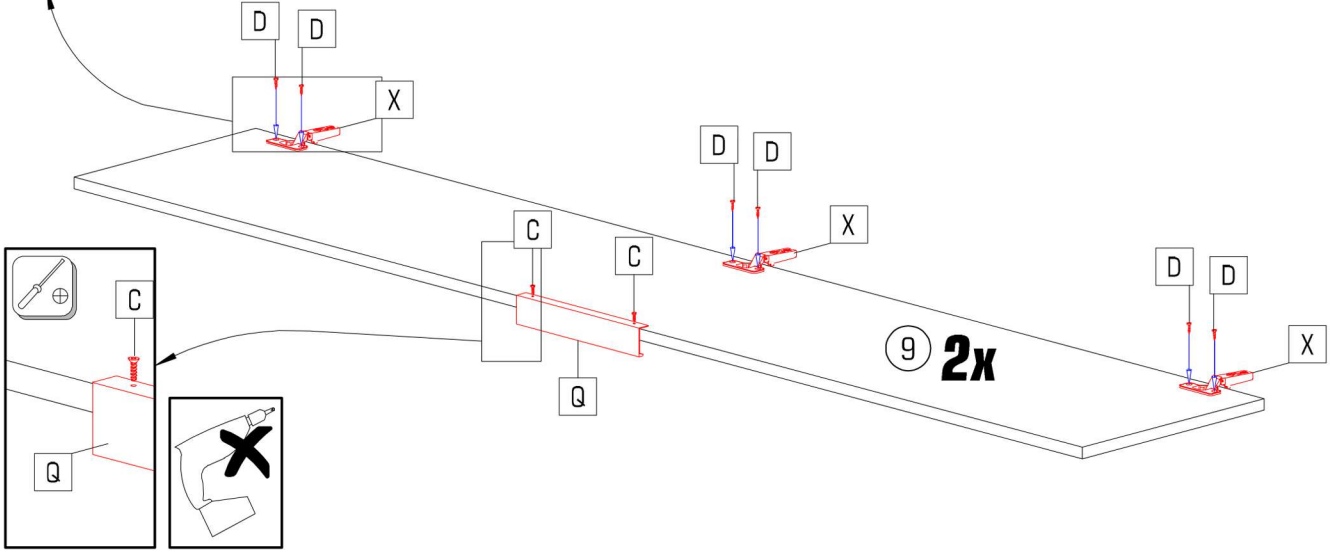
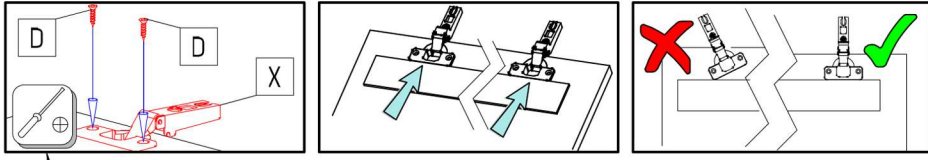

			
Ø3,0x12	Ø3,5x15	L=230	
C 4x	D 12x	Q 2x	X 6x



	
Ø8	
A 1x	F 8x

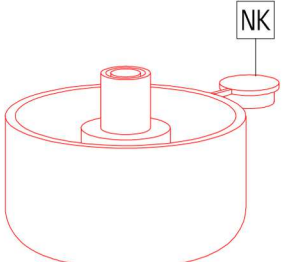
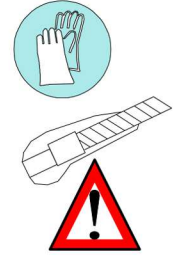
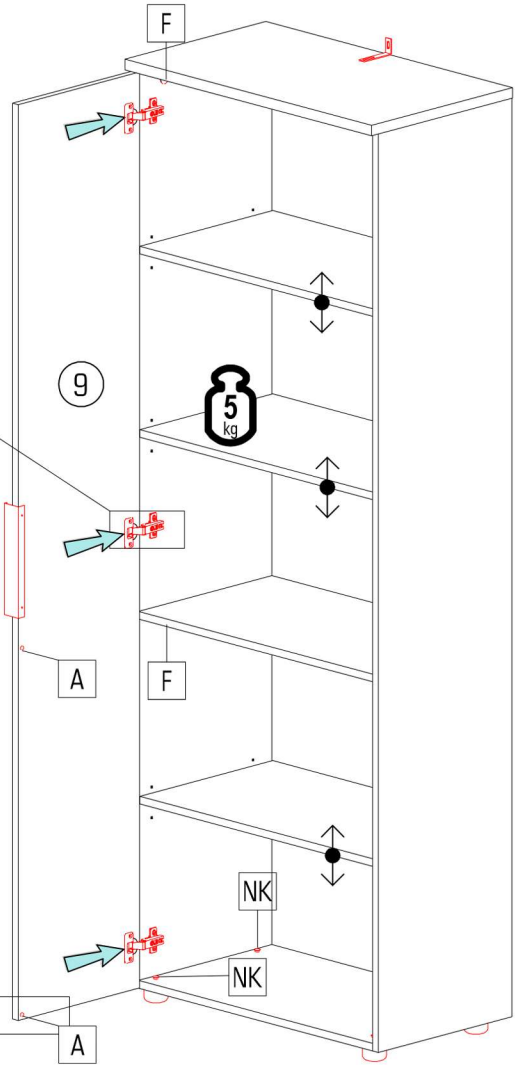
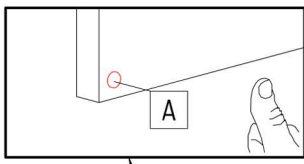
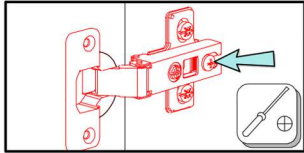
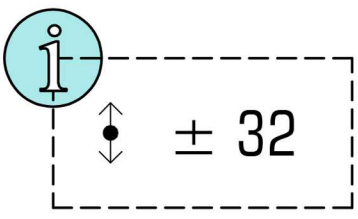

	Ø8
A	1x

