

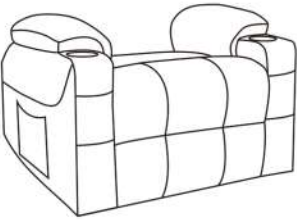

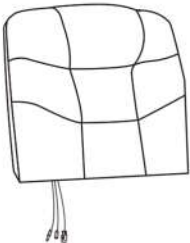



# HUDSON

<b>A</b> 	<b>B</b> 	<b>C</b> 	<b>D</b> 	<b>E</b> 	<b>F</b> 	<b>G</b> 
Základna židle	Opěrka zad	Napájecí kabel	Dálkové ovládání	Zástrčka	Napájení	Dálkové ovládání

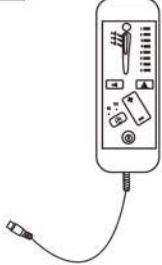

Drát č. 1 spojte s opěradlem a základnou židle.  
Vodič č. 2 se spojuje s opěrkou a napájecím kabelem (C).  
Kabel č. 3 se propojuje s opěradlem a dálkovým ovládním (D).  
POZNÁMKA: Spojují se dva vodiče stejné barvy.

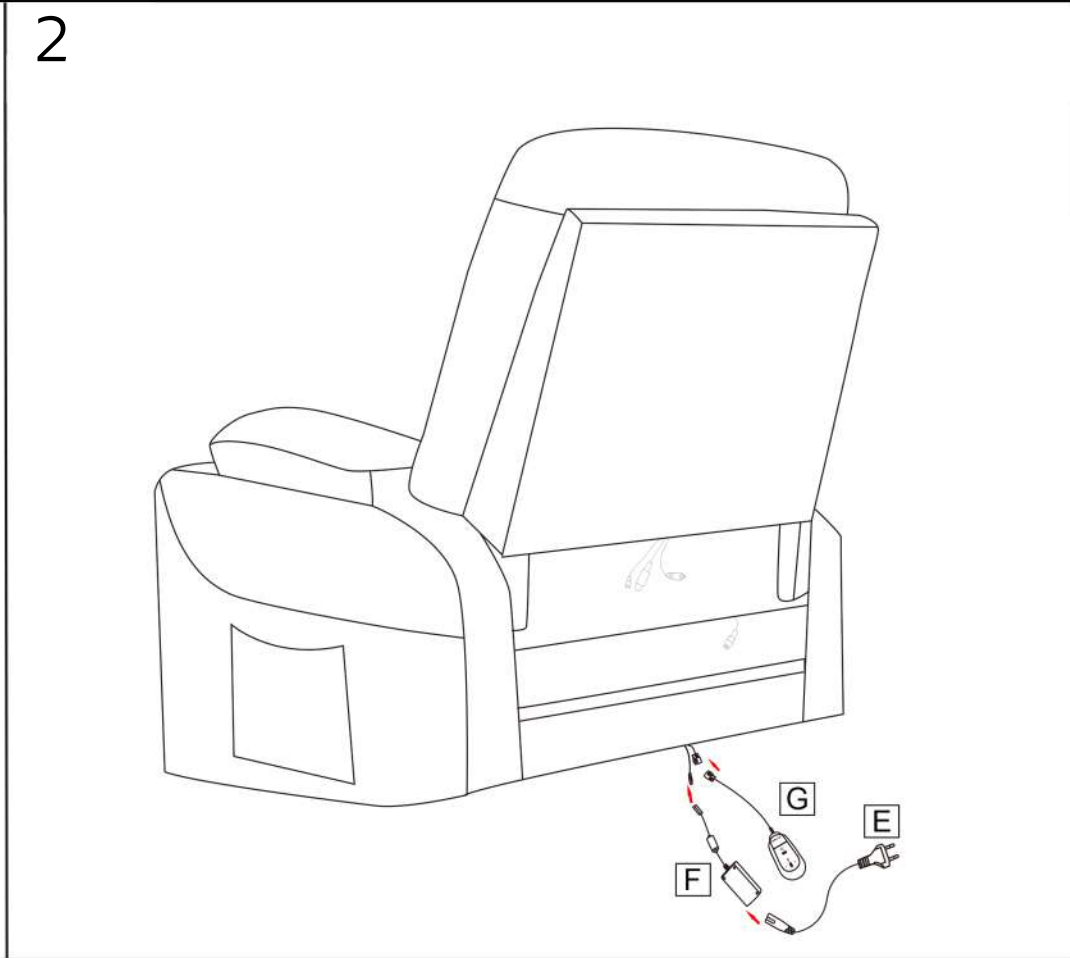
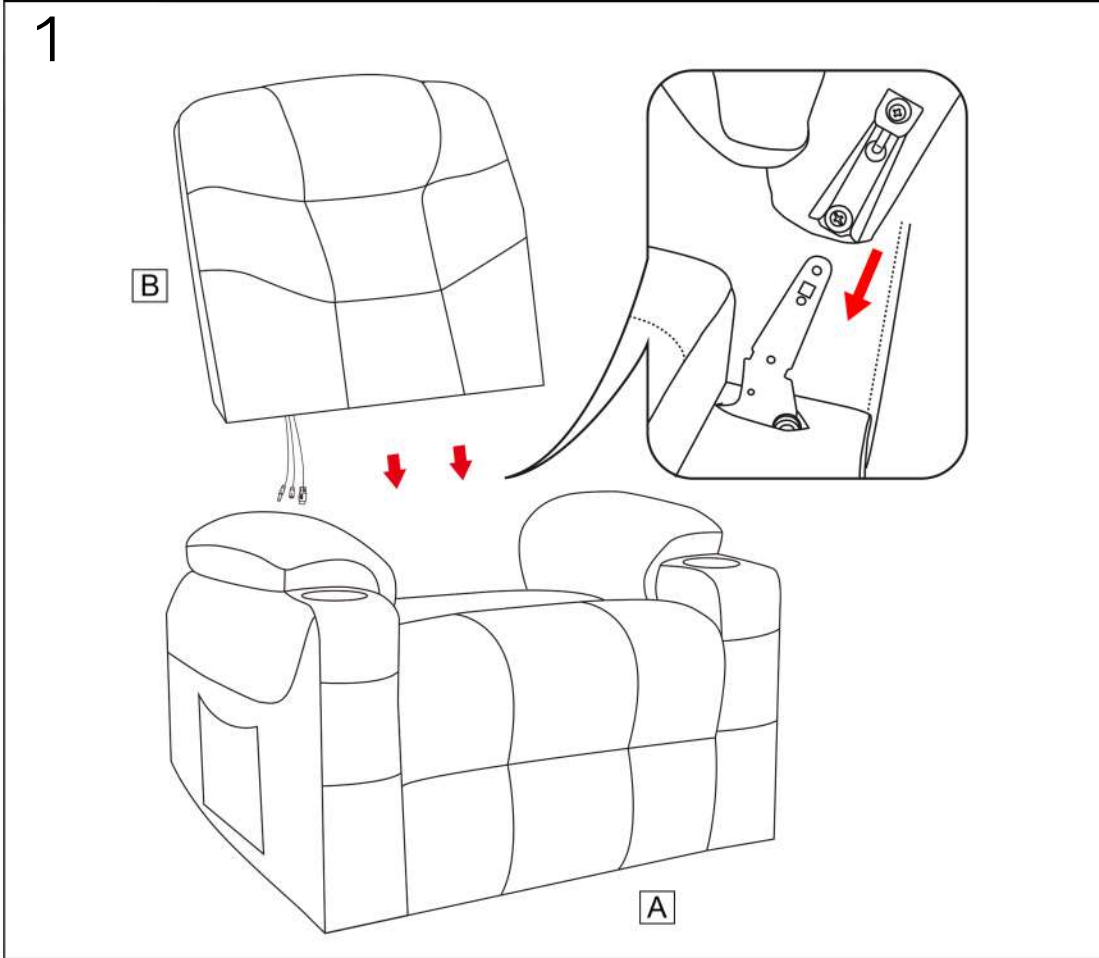
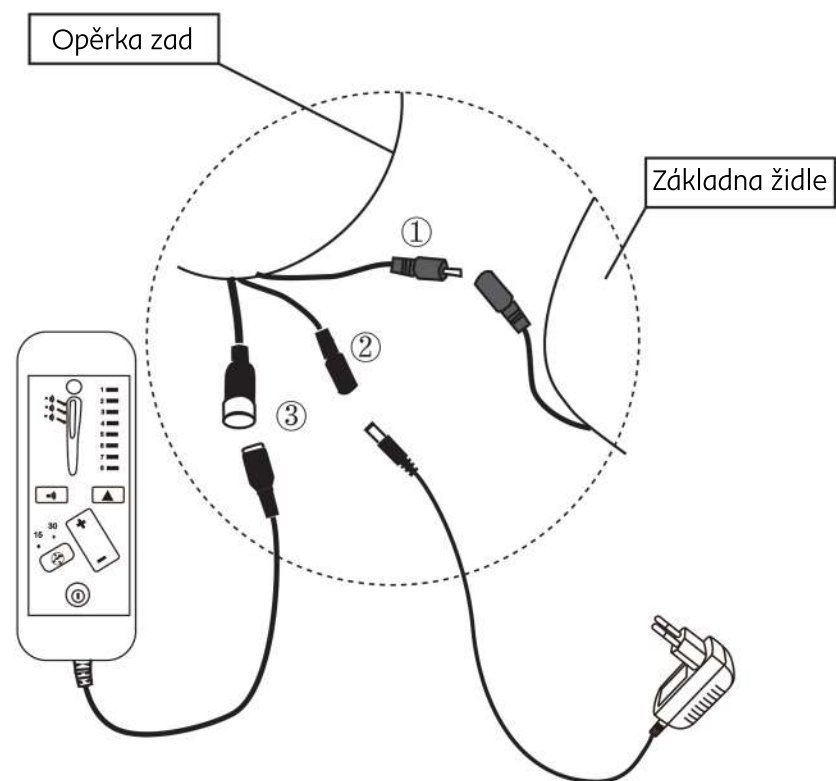
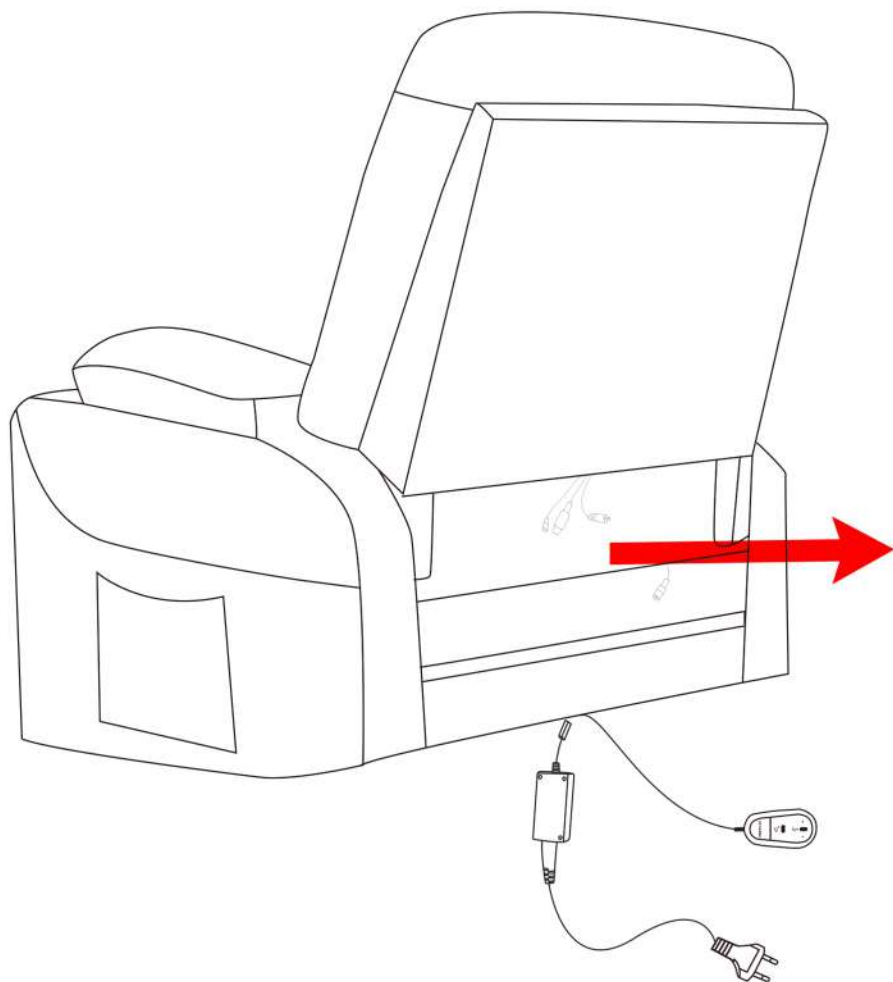

Jak si lehnout?

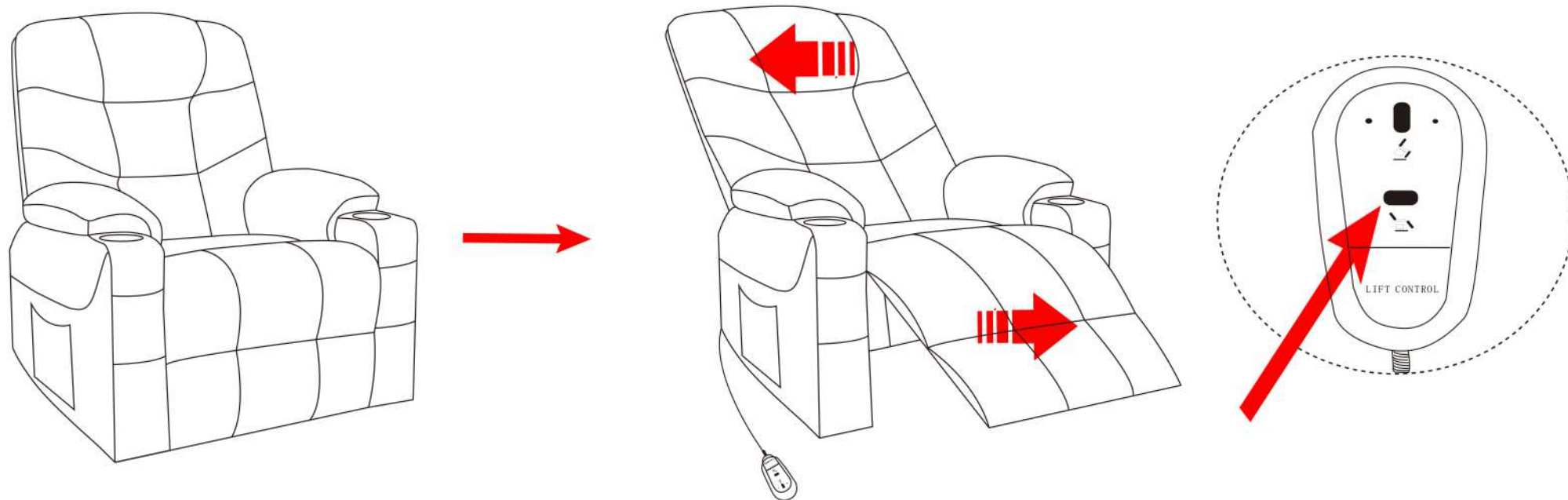

Jak dostat západku opěrky nohou dolů?

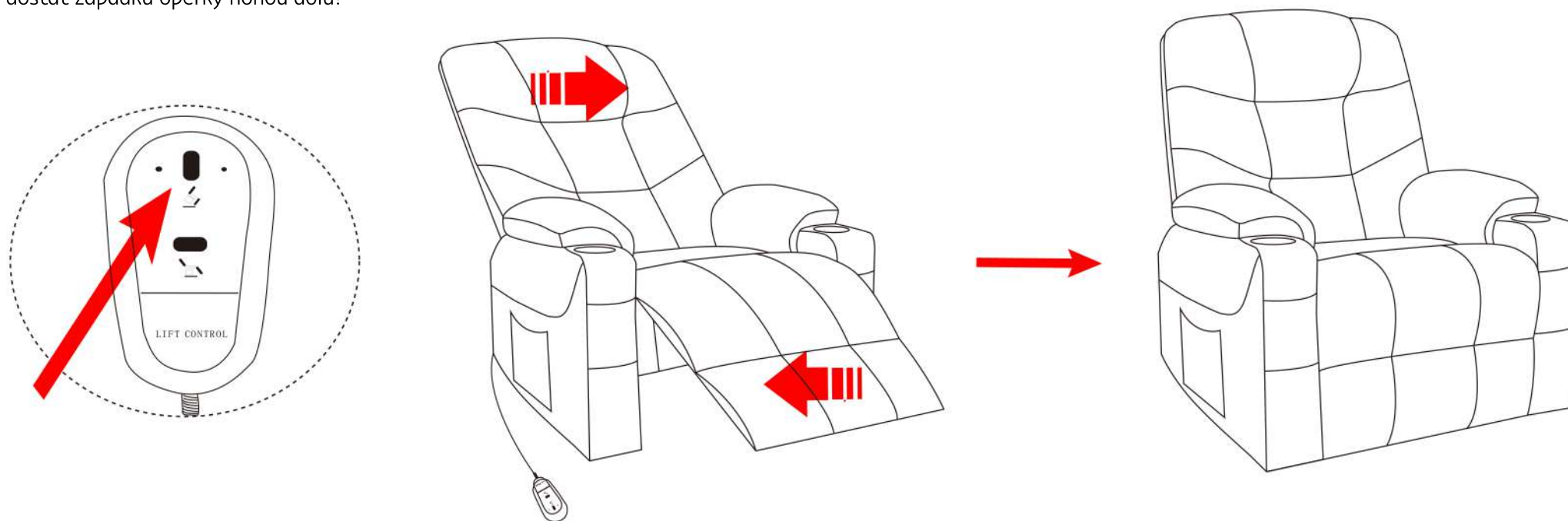

Jak zvednout?

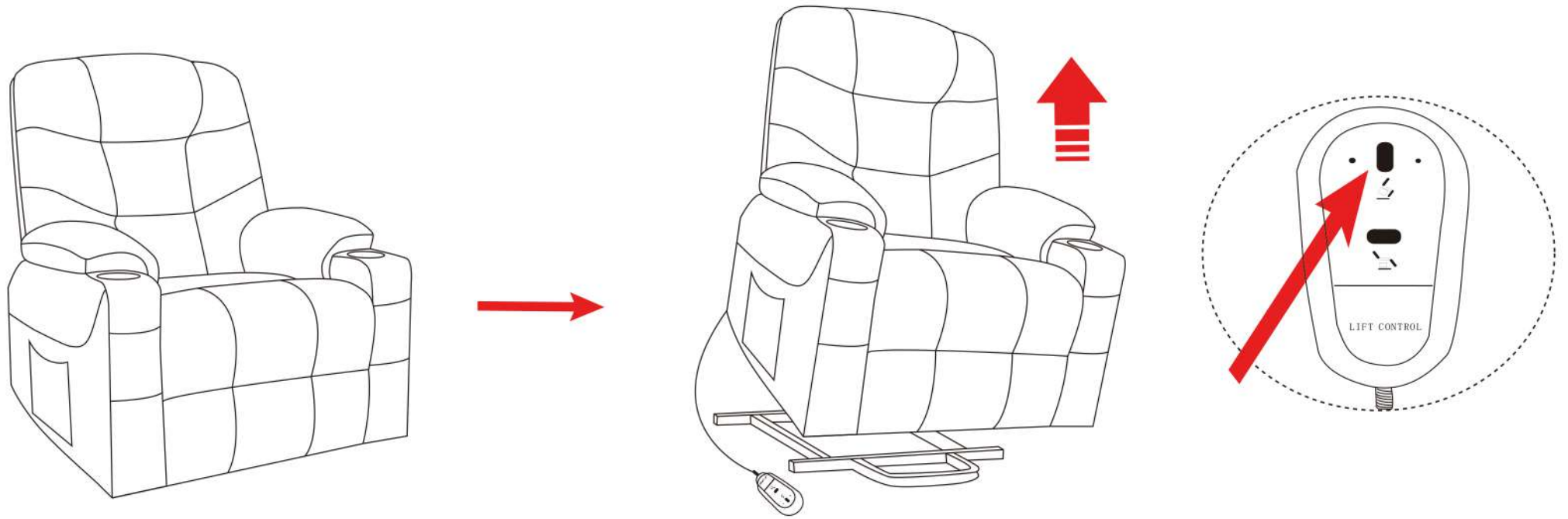

Jak dolů?

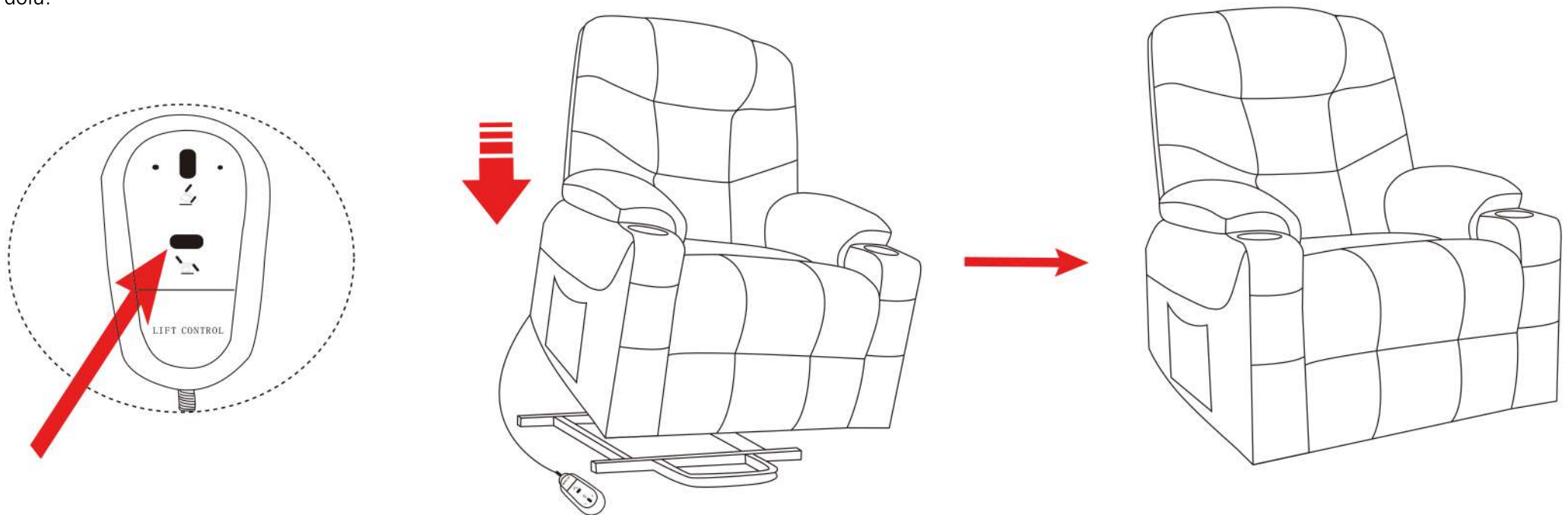

# Návod na montáž masážního křesla

## Jak používat dálkové ovládání?

