

# ATLANTA

# 8X--AT 1R

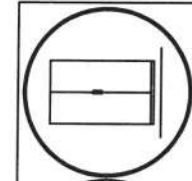

## 8X--AT 1R

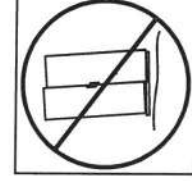
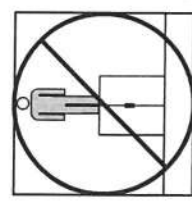
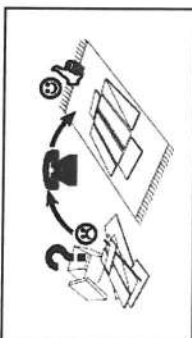
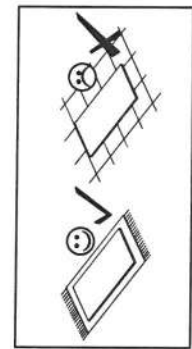
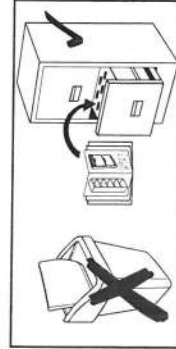
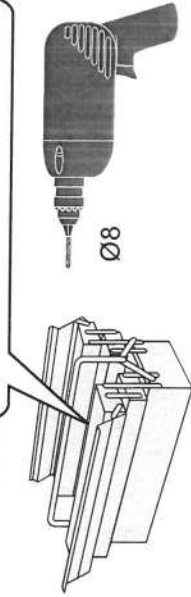
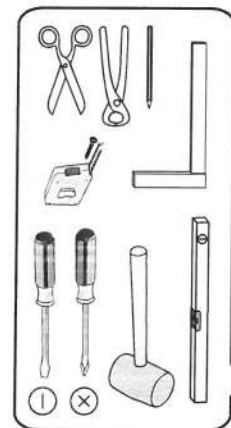
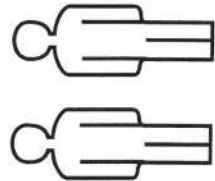
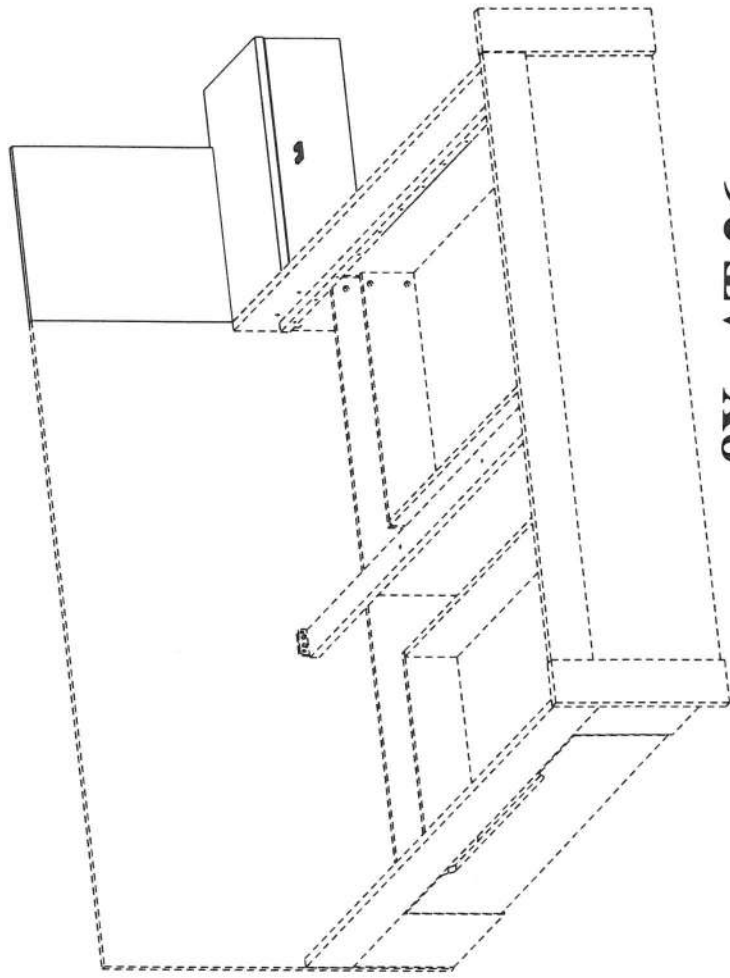





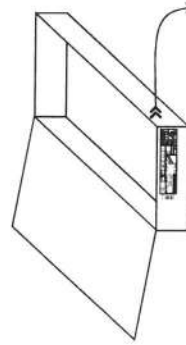
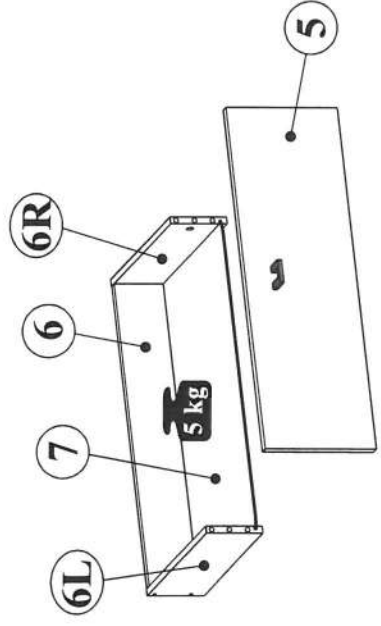
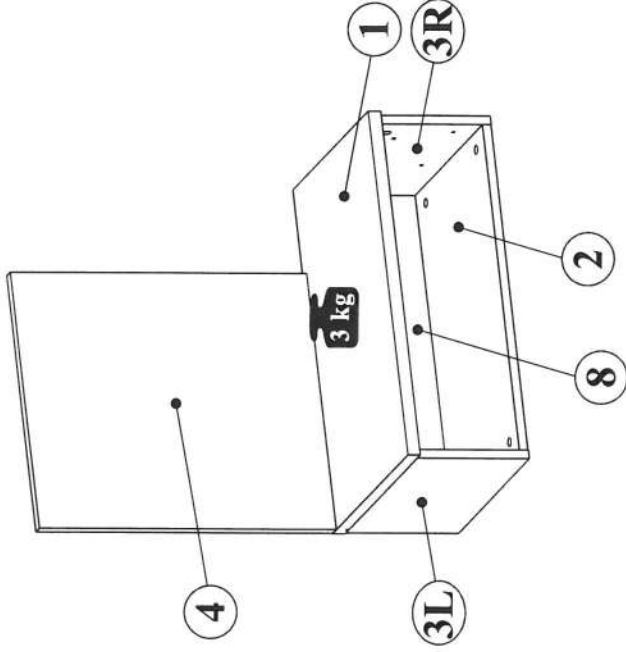
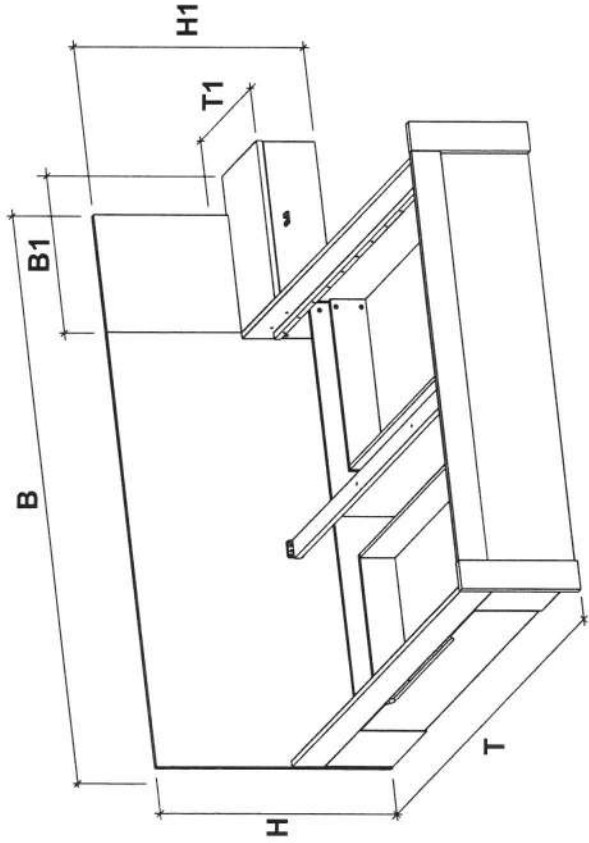

## 8X--AT 26

B - 2318mm  
 H - 900mm  
 T - 2066mm  
 B1 - 600mm  
 H1 - 738mm  
 T1 - 380mm





1	600x380	1	1/1
2	568x361	1	1/1
3L,3R	198x362	2	1/1
4	447x518	1	1/1
5	596x194	1	1/1
6L,6R	302x100	2	1/1
6	528x100	1	1/1
7	539x300	1	1/1
8	577x191	1	1/1







**NR 1**

<b>B1</b>  φ 8x28	x10
<b>M1</b>  φ15x12mm	x8
<b>T1</b>  5x39mm	x8
<b>K7</b>  7x70	x3
<b>A19</b>  M6x35	x2
<b>G11</b> 	x2
<b>J23</b> 	x6



**NR 2**

<b>F59</b>  110x50x1.5	x2
<b>P11</b>  4x13	x16
<b>C18</b>  5mm	x4

**NR 3**

<b>Q30B</b>  L-300mm	<b>x1L/1R</b>
<b>E2</b>  6,0x8	x4
<b>S3</b>  3,5x13	x4
<b>M2</b>  φ12x10mm	x2
<b>T2</b>  5x35mm	x2
<b>P5</b>  4x30	x4

**NR 4**

<b>U173</b> 	x1
<b>A2</b>  M4x25	x2

C 1/1



# ATLANTA

## 8X--AT 1R

4 / 12

### 1

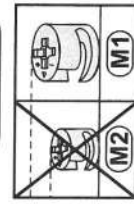
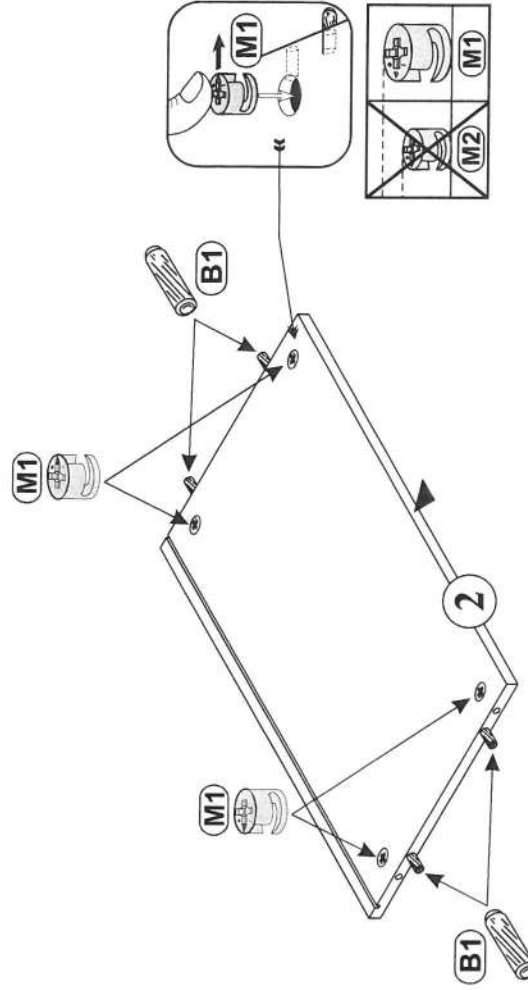
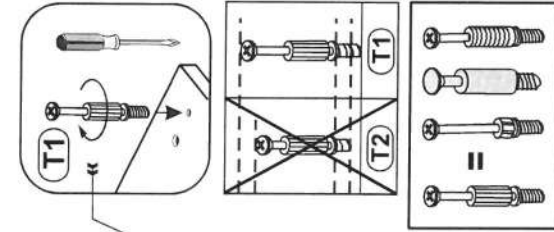
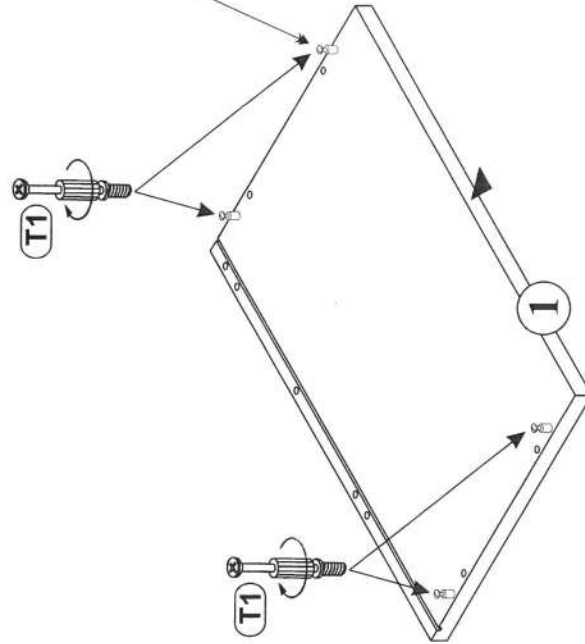

2

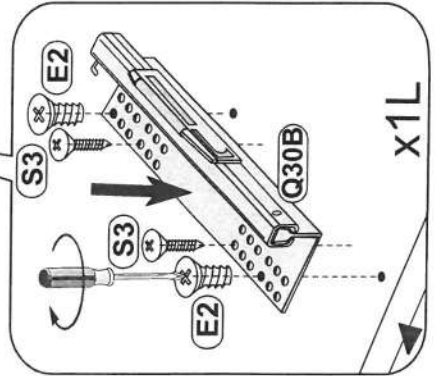
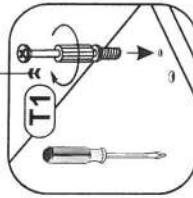
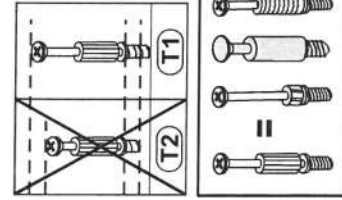
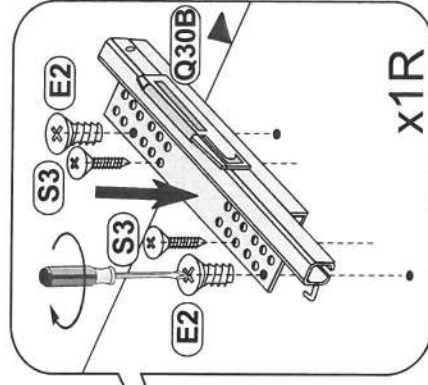
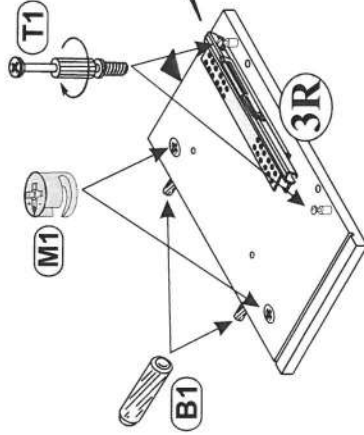
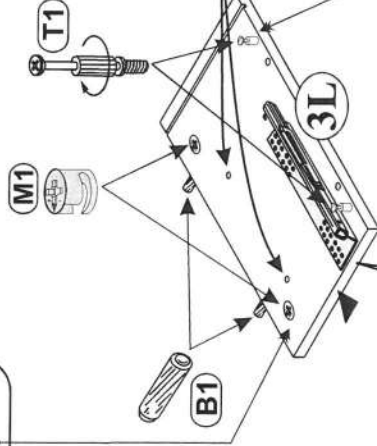
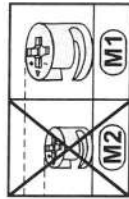
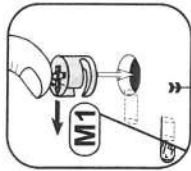
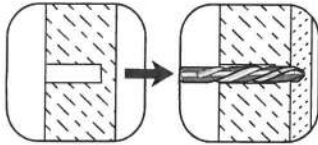
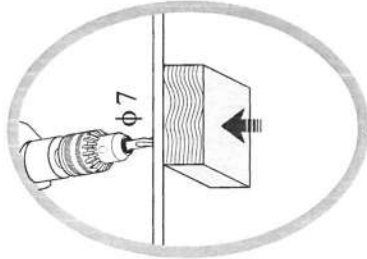
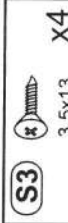
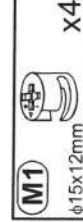
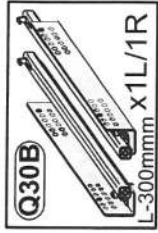

x1L

x1R

### 3

- (F59)** 110x50x1,5 x2
- (P11)** 4x13 x8

- (B1)**  $\phi$  8x28 x2

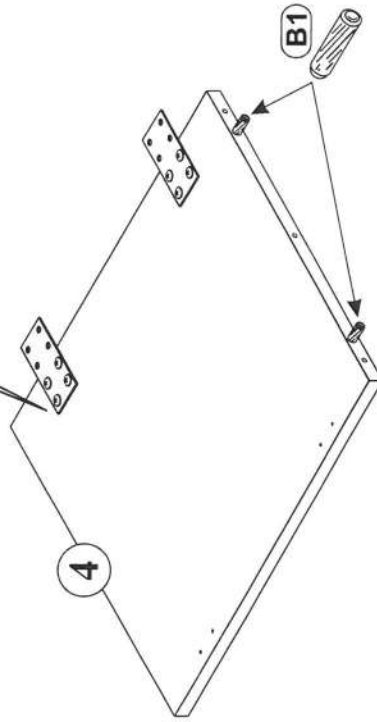
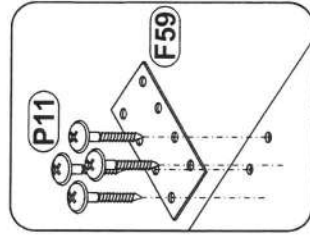

### 4

- (K7)** 7x70 x3

- (G7)** S4 x1

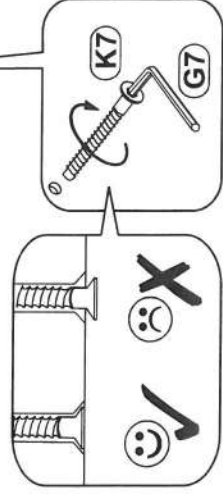
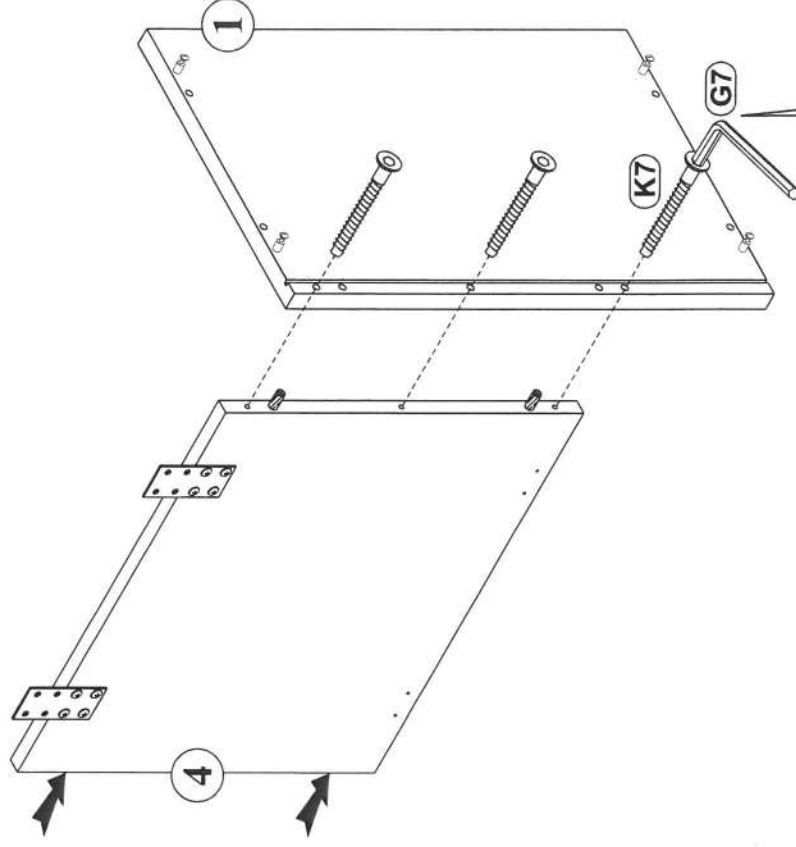
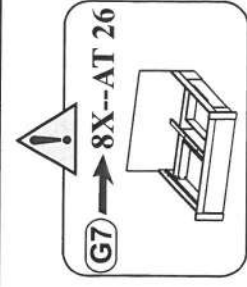

5

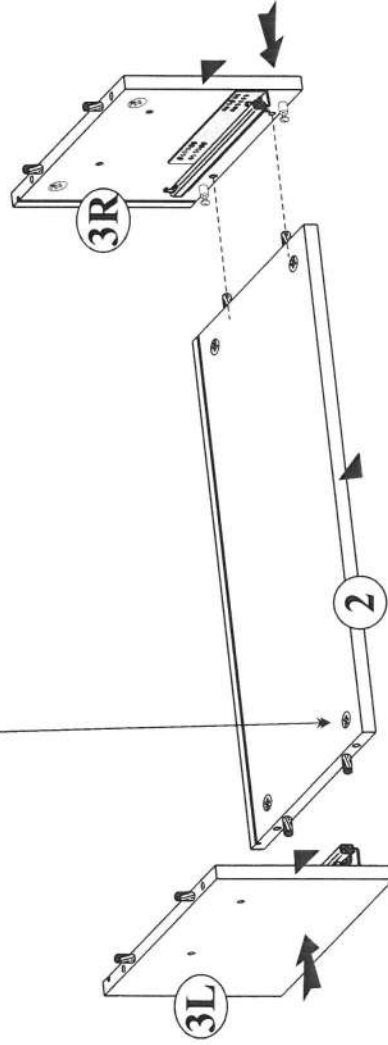
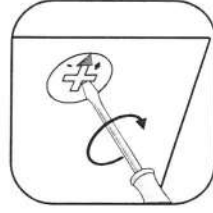
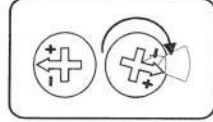
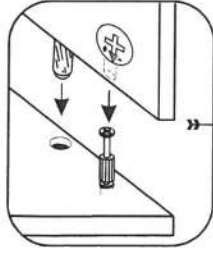

6

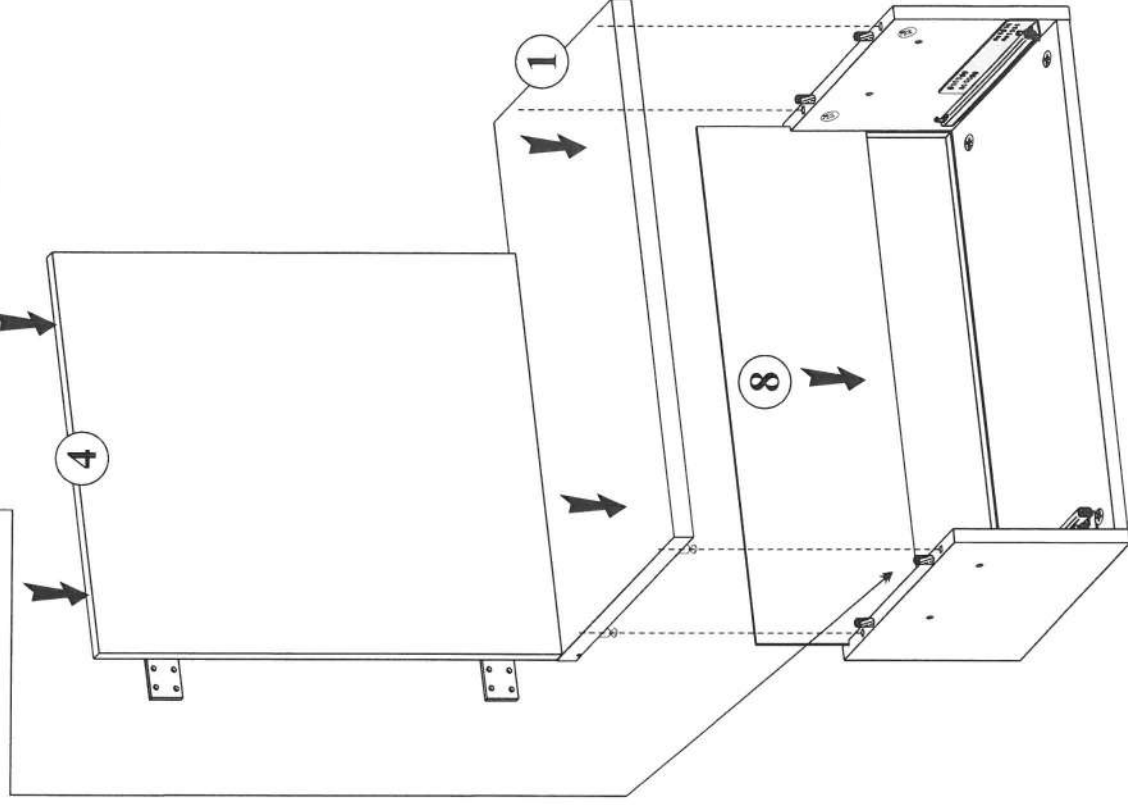
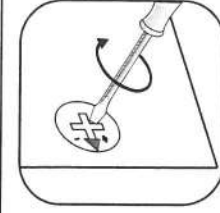
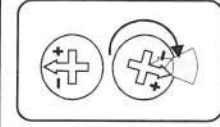
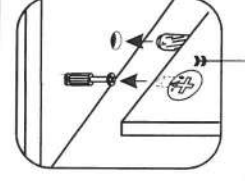

7

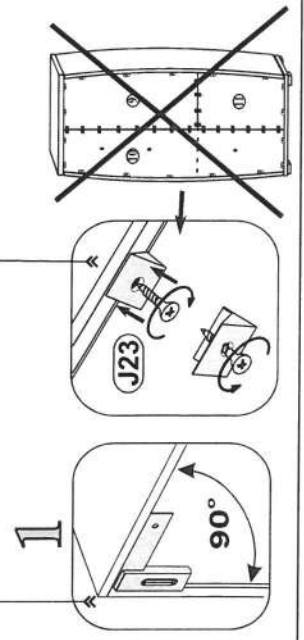
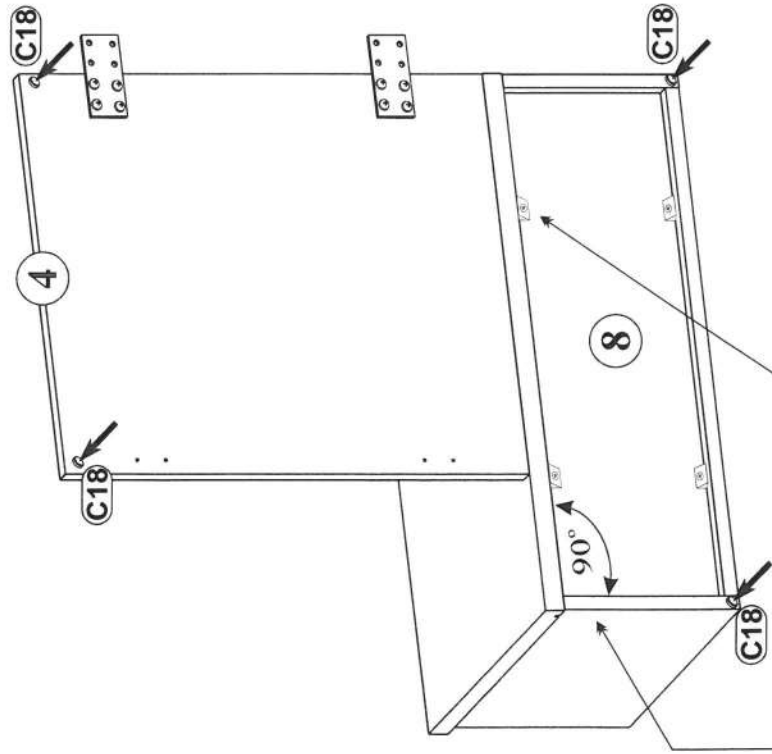
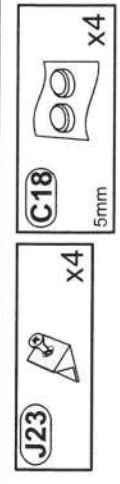

8

8X--AT 26

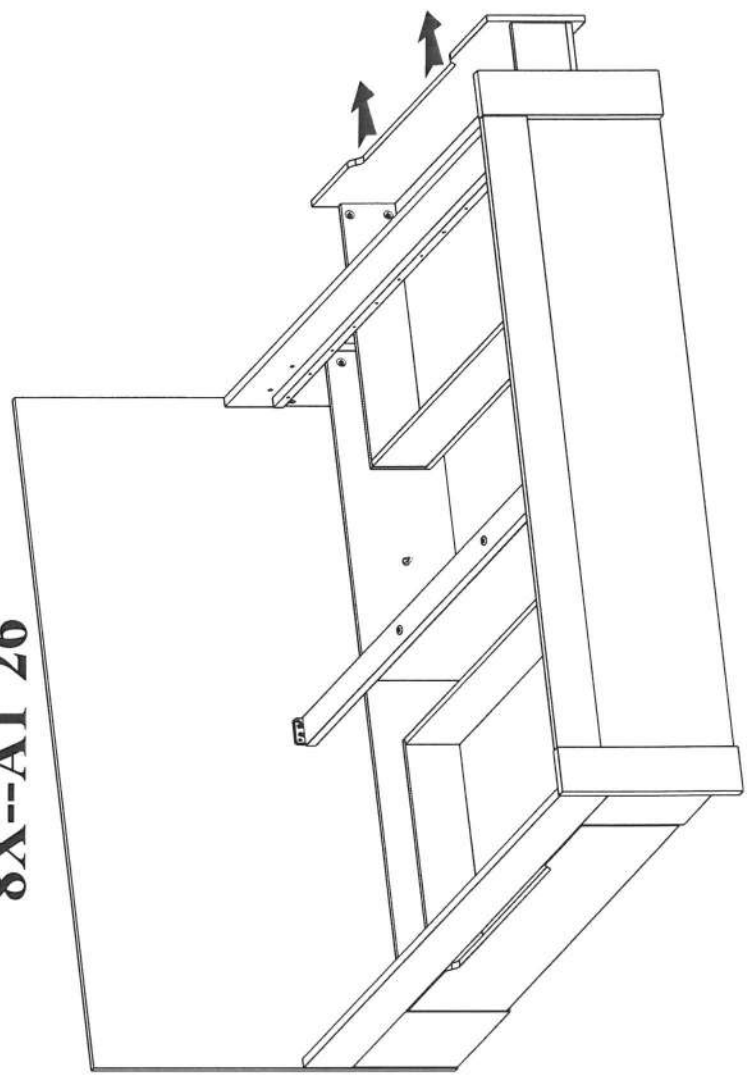



9

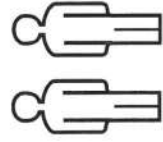
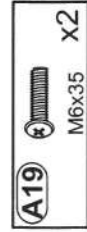

10

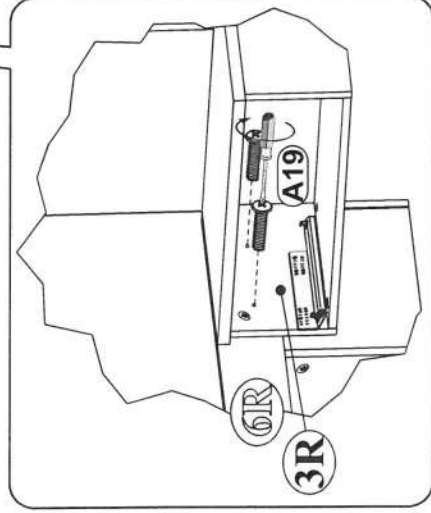
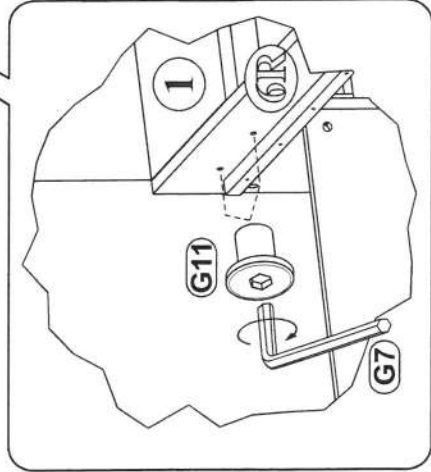
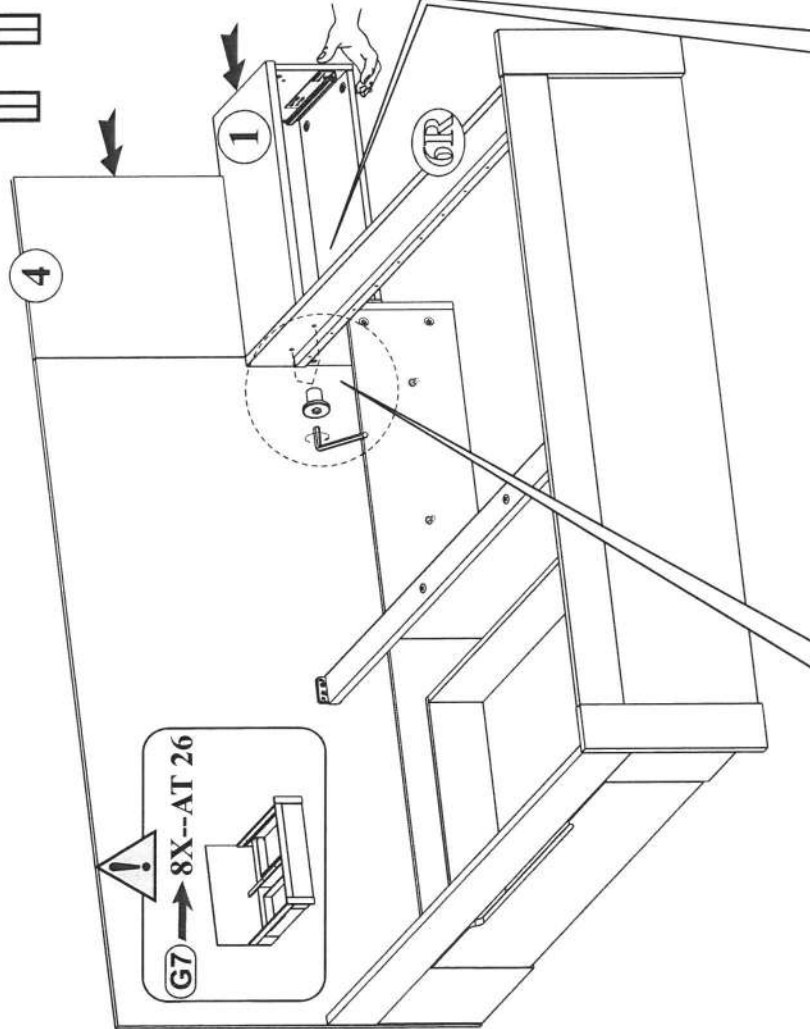
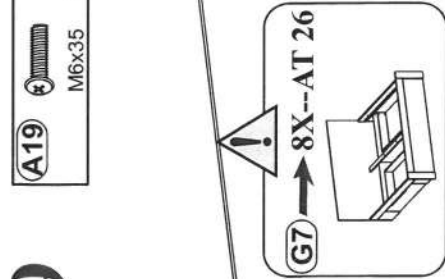
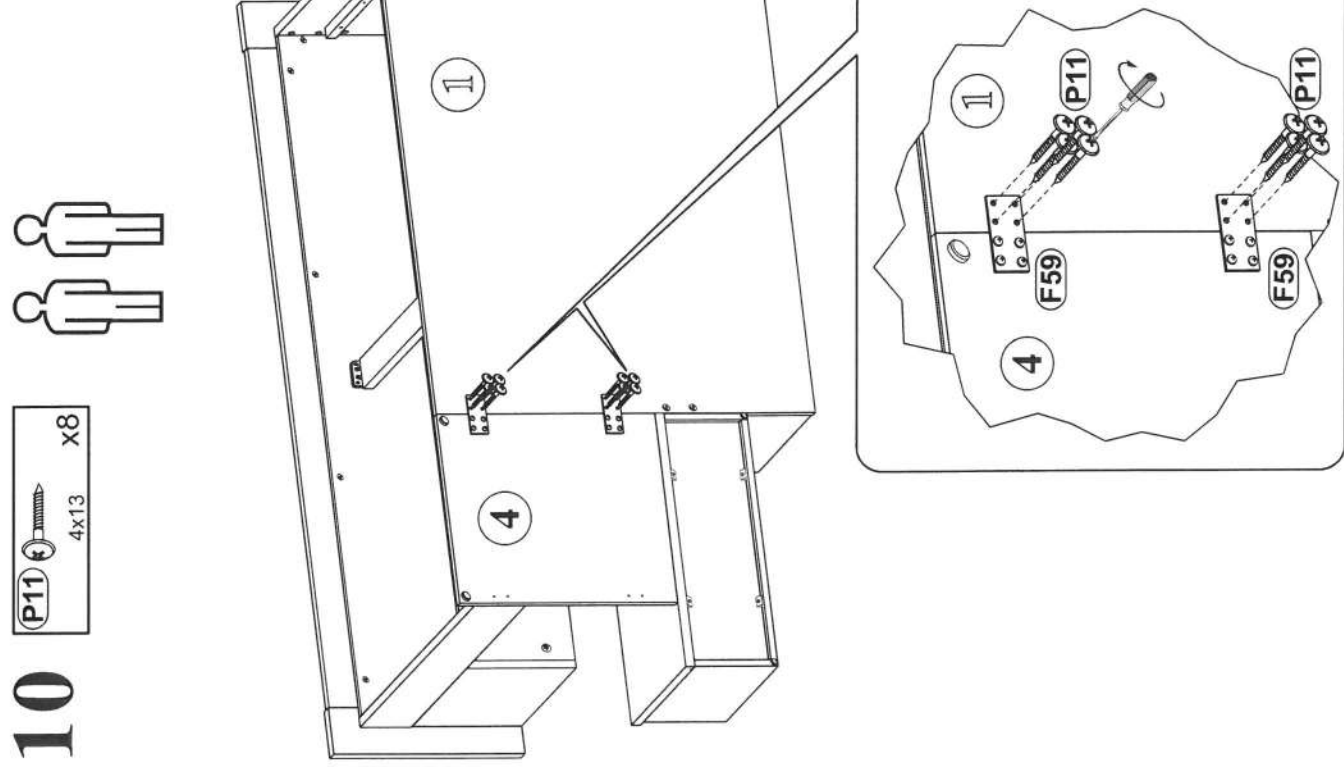
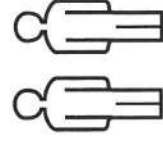

11

- (M2)  $\phi 12 \times 10 \text{mm}$  x2
- (T2)  $5 \times 32 \text{mm}$  x2

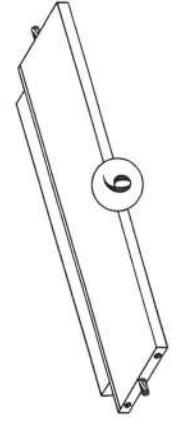
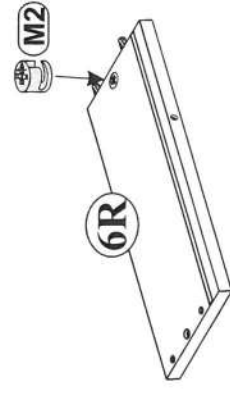
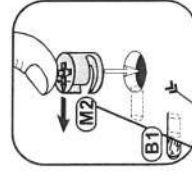
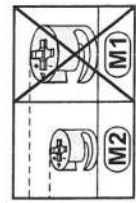
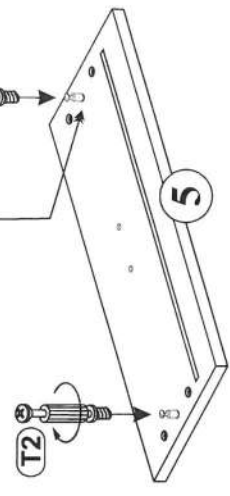
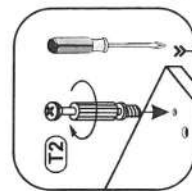
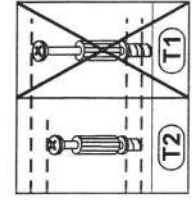

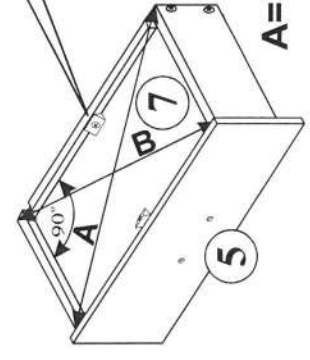
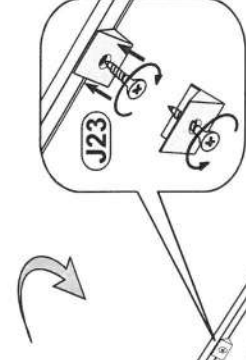
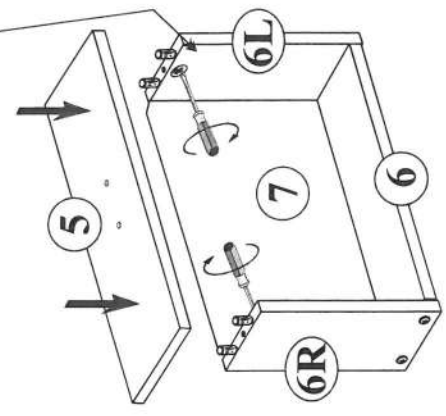
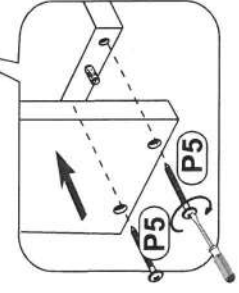
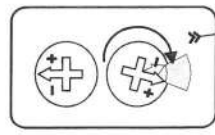
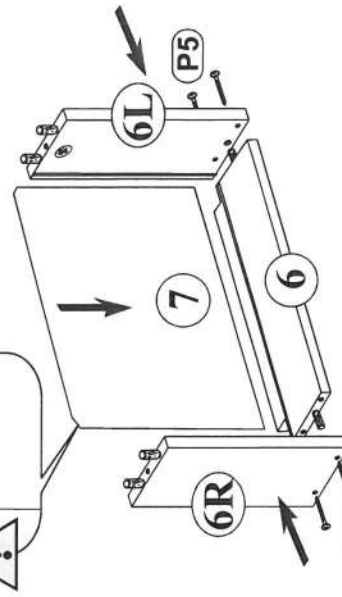

12

- (P5)  $4 \times 30$  x4
- (J23) x2



A=B

-  U173 x1
-  A2 M4x25 x2

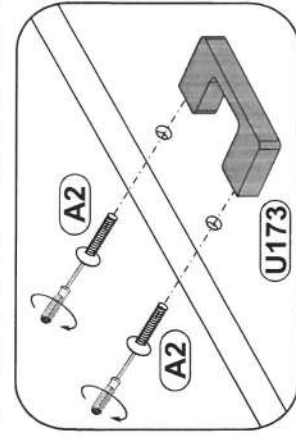

13

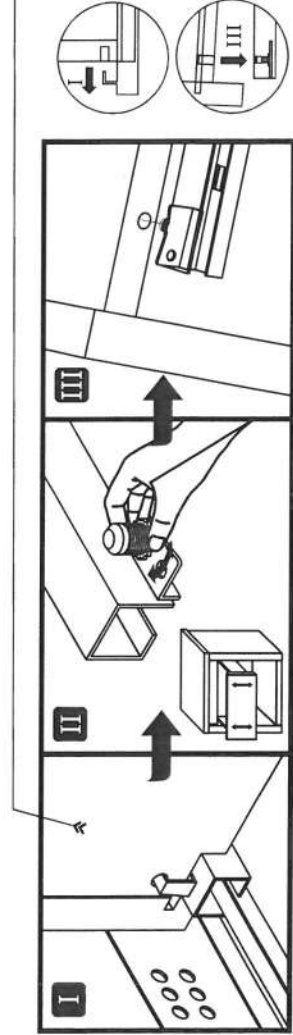
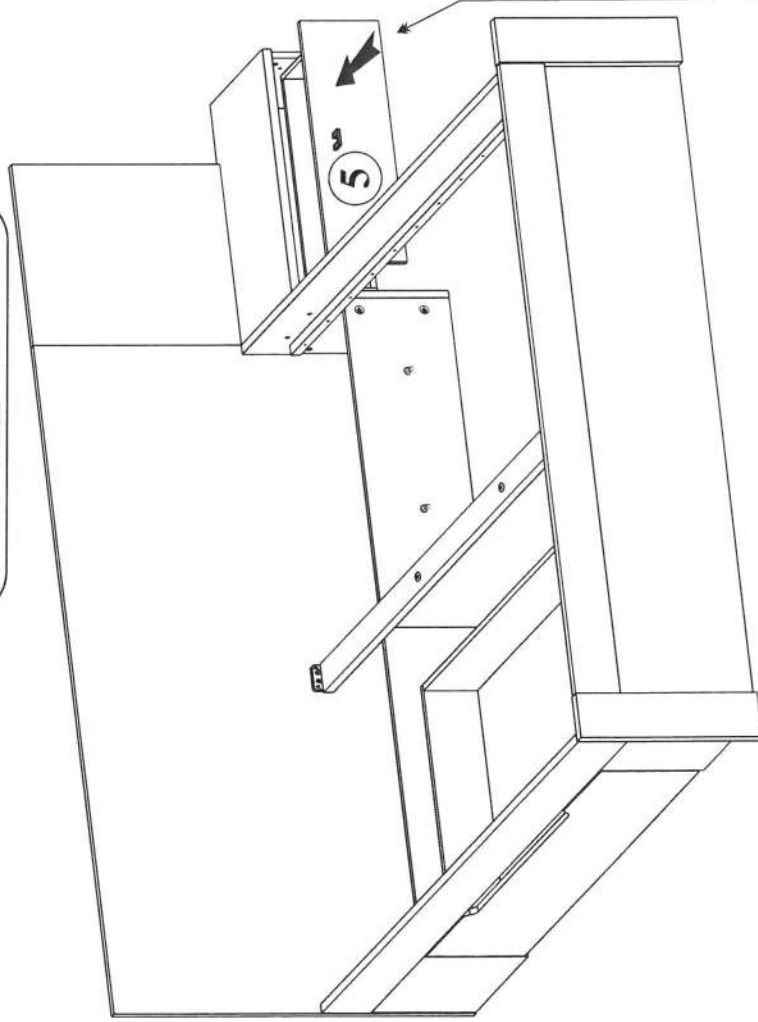

14

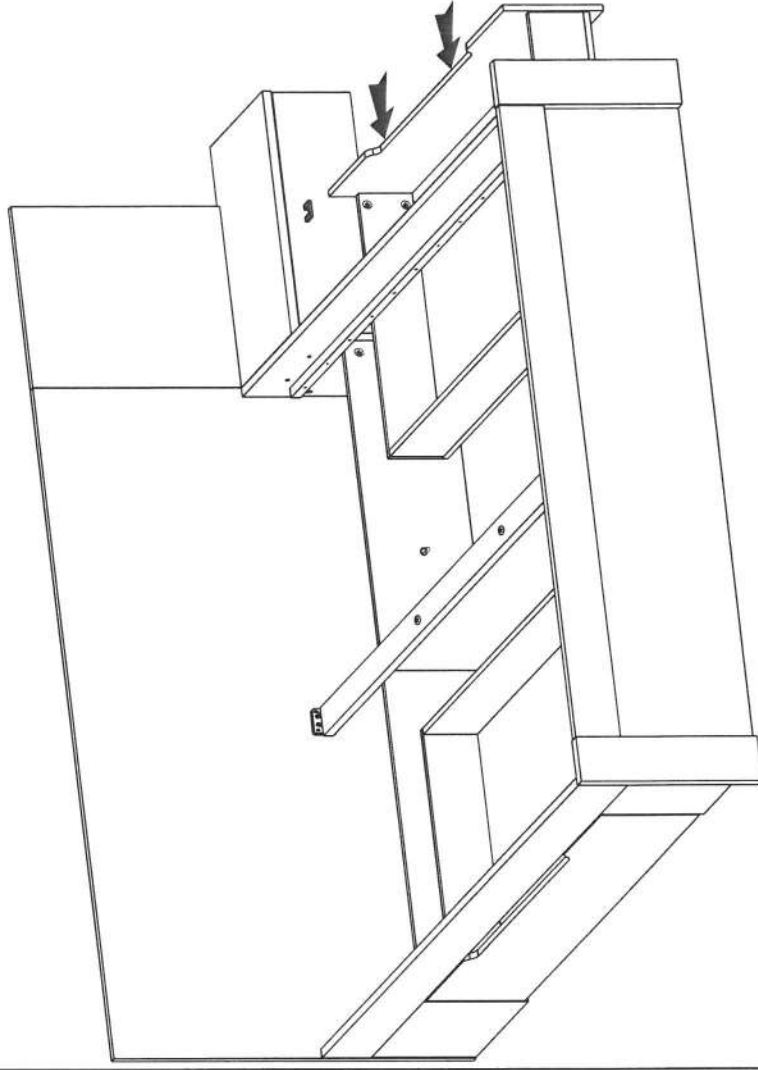

ATLANTA

8X--AT 1R

12 / 12

15

