

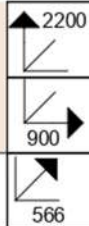

BETTY 02  
BE02-003-00







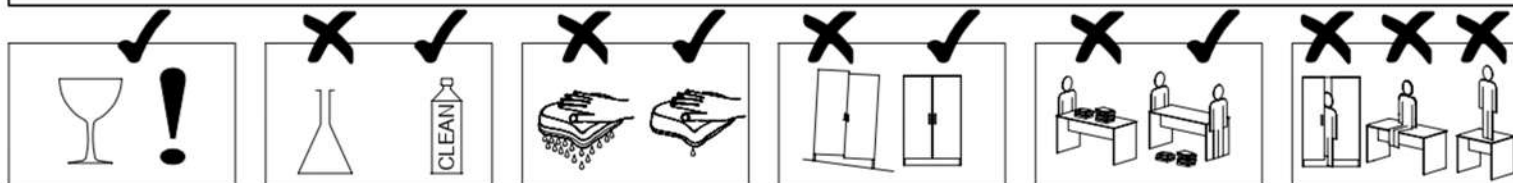
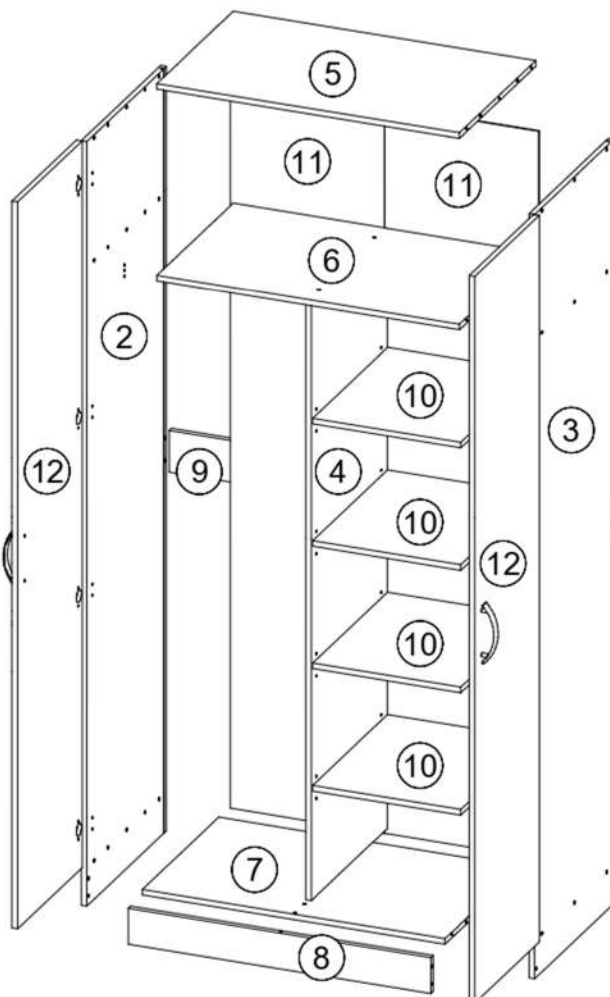
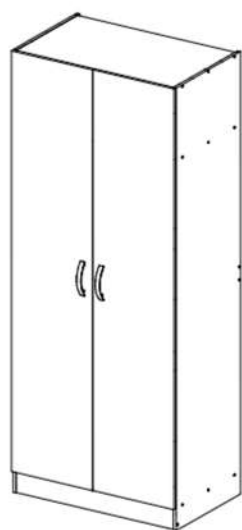

REKLAMÁCIÓ ESETÉN BE KELL JELENTENI A CÍMKÉN LÁTHATÓ  
GYÁRTÁSI SZÁMOT

A 18x	B 29x	C 24x	D 2x	F 5x	G 22x	H 25x	J 2x	K 8x	L 8x
M 1x	P 16x								





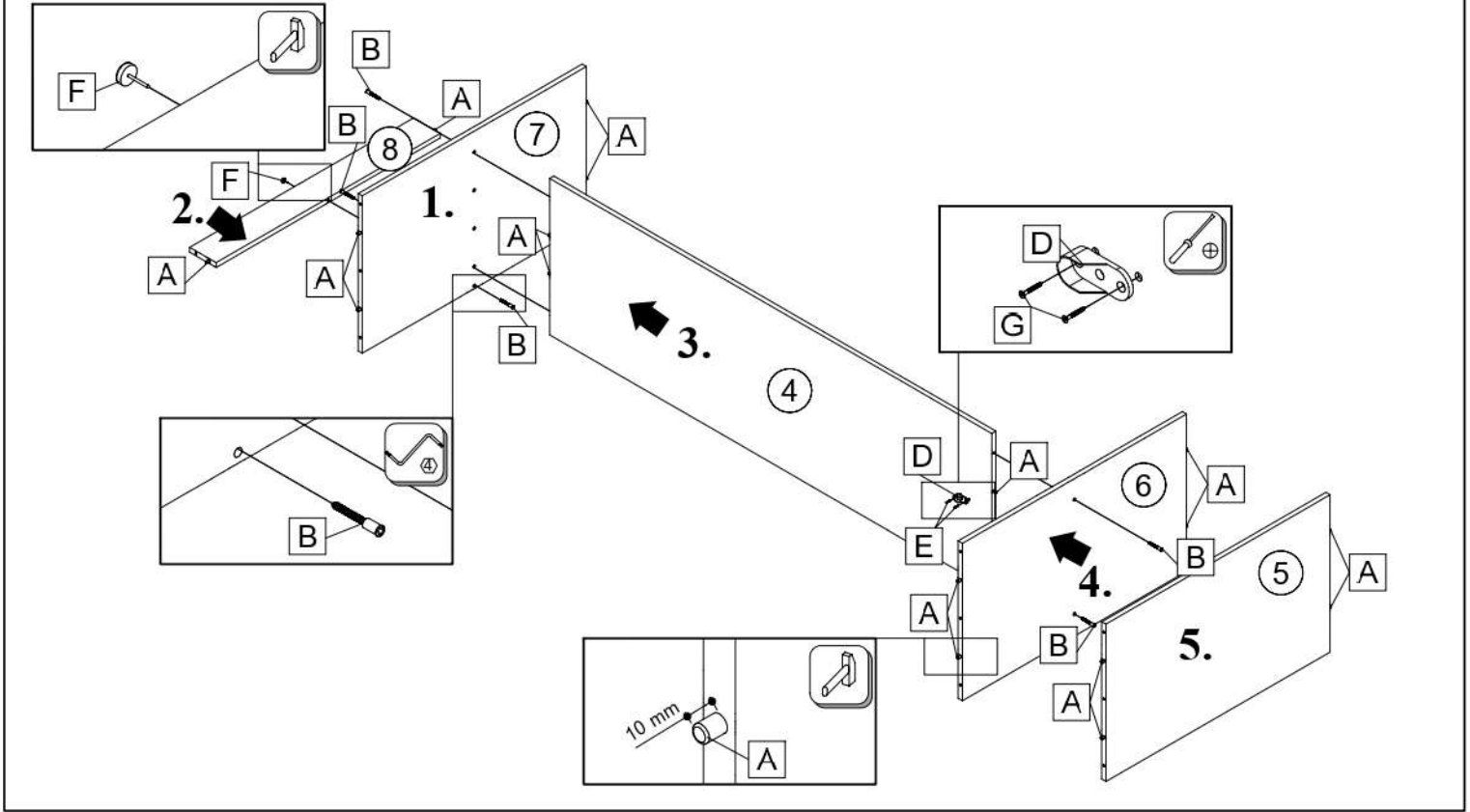

1h 30min		4	5,5 x 125	≤ 0,5 kg	3m		0,6m

ID	ID					
03325	②	2200*550*16	1x			3/4
01359	③	2200*550*16	1x			3/4
01360	④	1712*526*16	1x	1/4		
01316	⑤	868*528*16	1x	1/4		
01361	⑥	868*528*16	1x	1/4		
01362	⑦	868*528*16	1x	1/4		
01318	⑧	103*868*16	1x	1/4		
01319	⑨	868*120*16	1x	1/4		
01363	⑩	425*518*16	4x	1/4		
01320	⑪	2093*442*2,5	2x			3/4
01343	⑫	2092*446*16	2x			2/4







				
A 18x	B 5x	D 1x	G 3x	F 1x

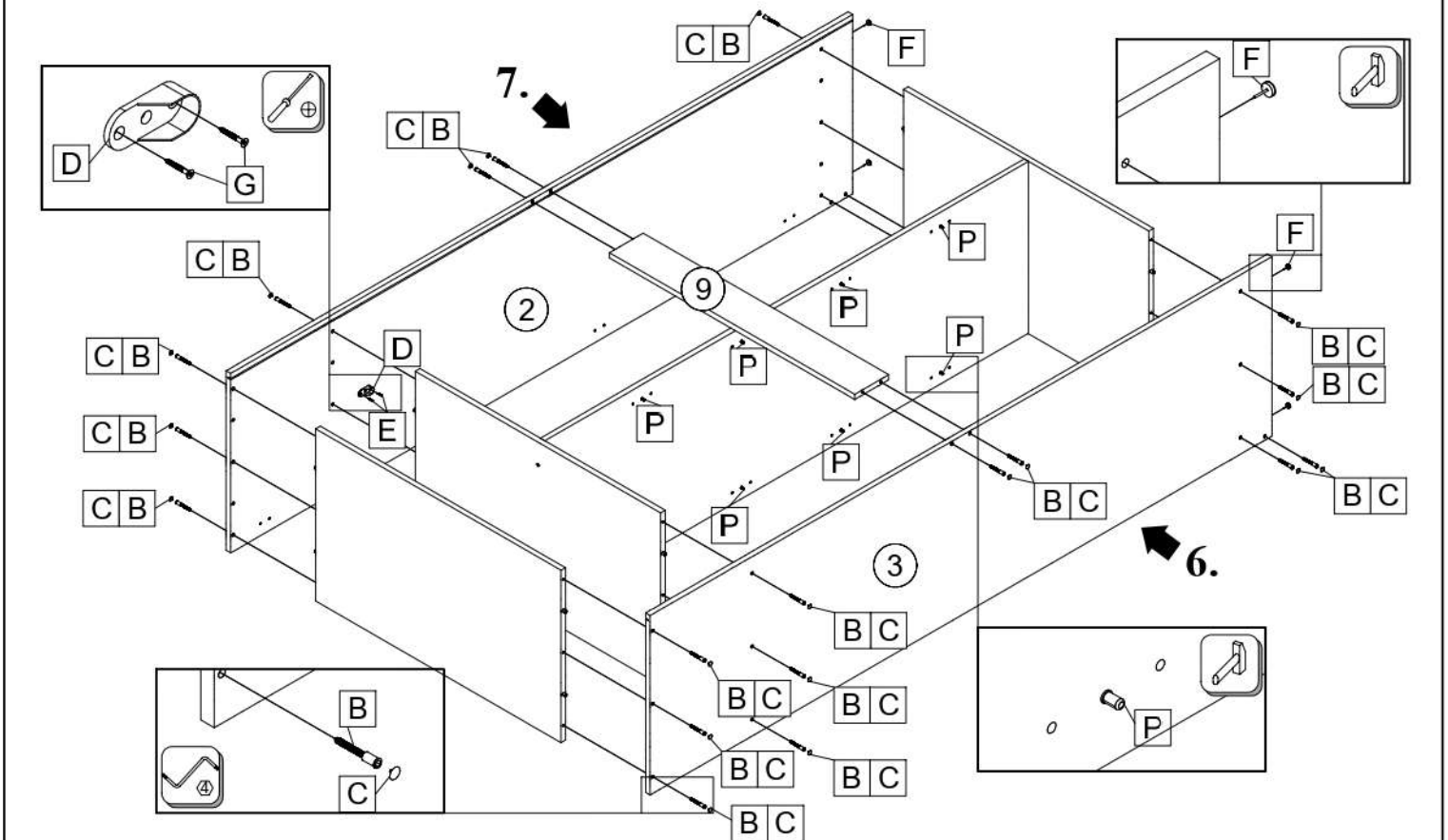

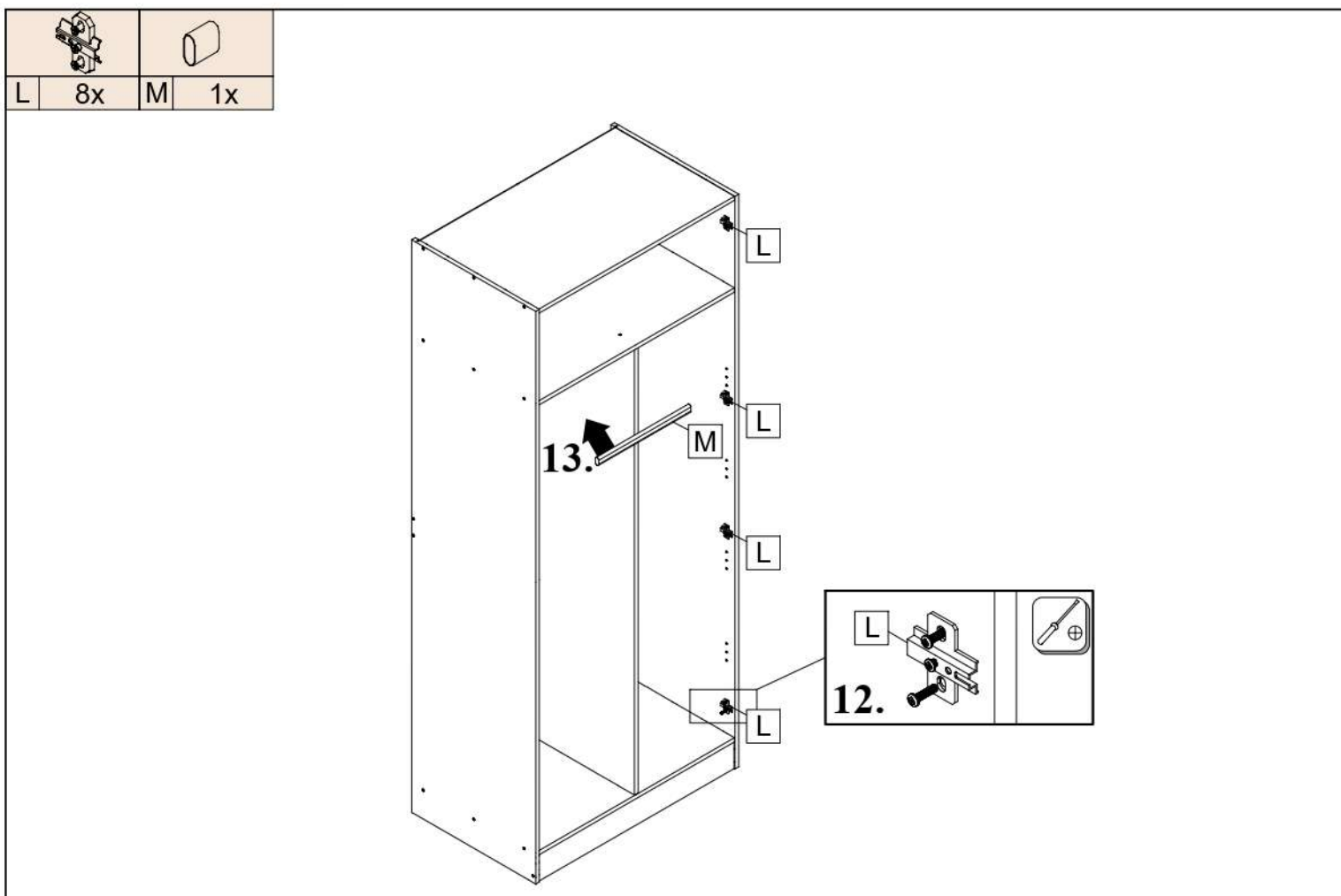
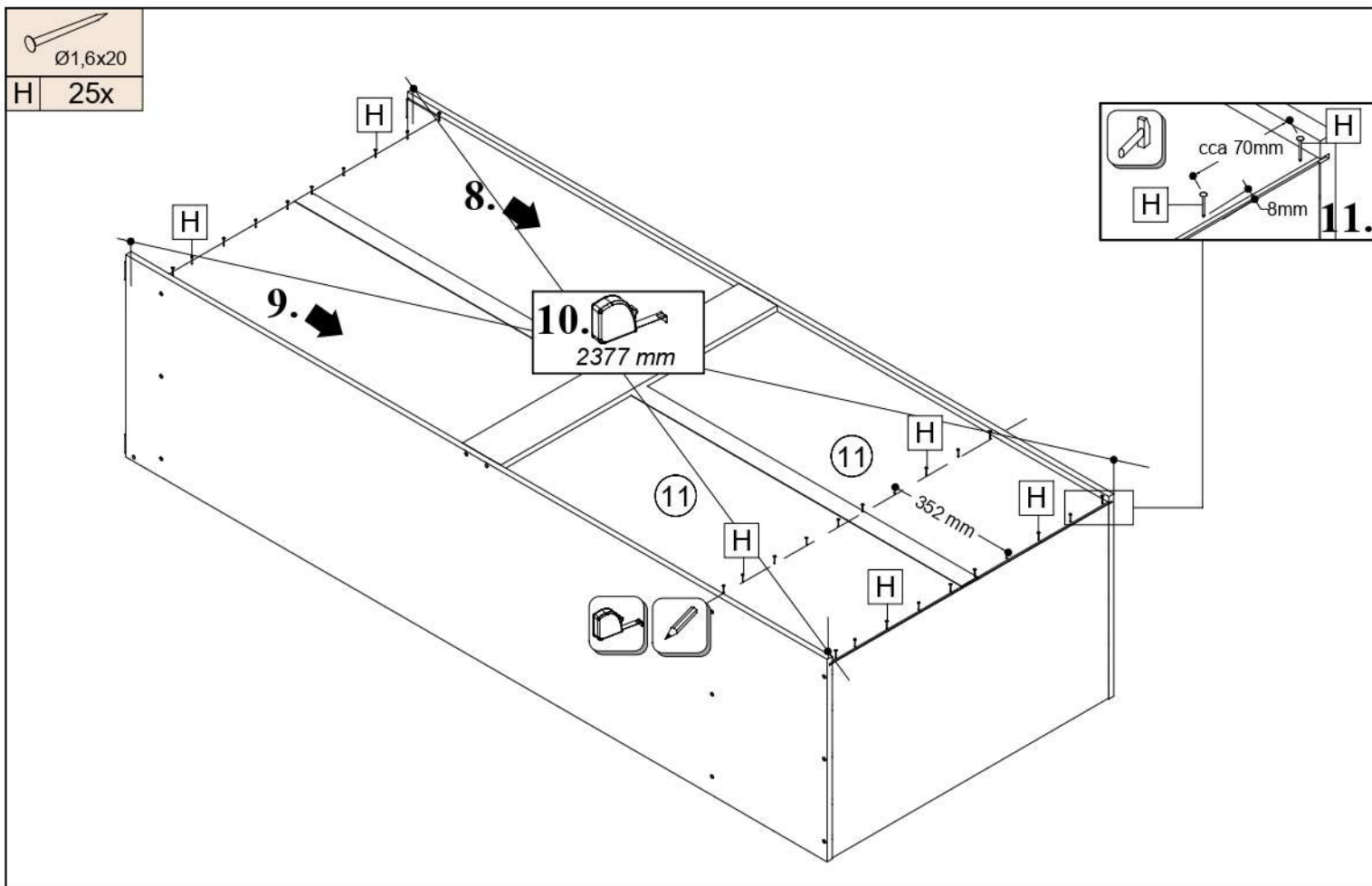
					
B 24x	C 24x	D 1x	G 3x	F 4x	P 16x





		
Ø3,5x15		
G 16x	J 2x	K 8x

