

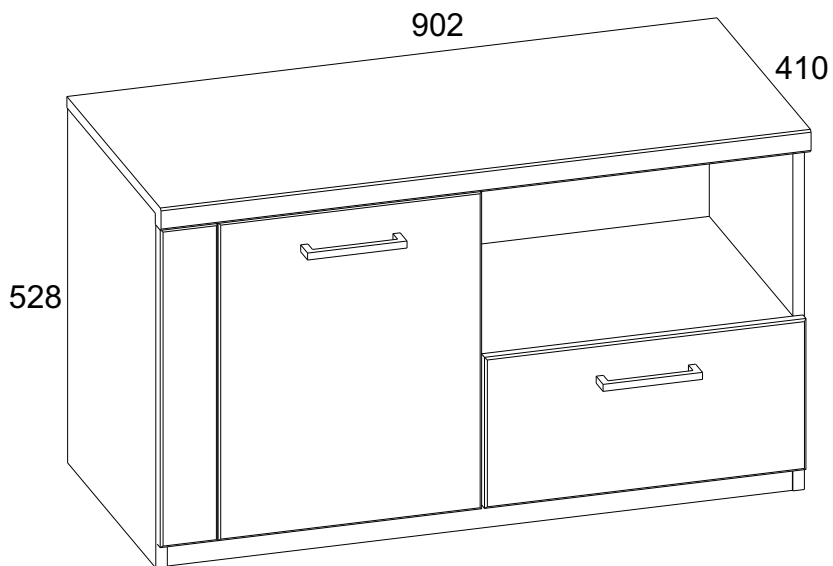

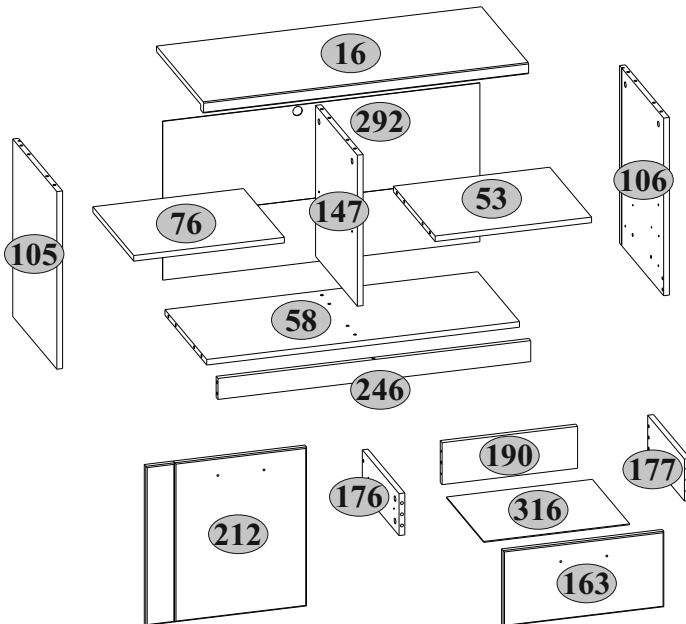











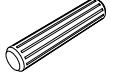
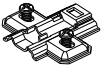
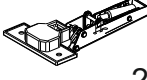

DORSI 1D1S

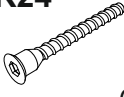

	L, mm	B, mm	H, mm	Q	
16	902	410	32	1	1/1
53	434	364	16	1	1/1
58	868	364	16	1	1/1
76	418	356	16	1	1/1
105	508	384	16	1	1/1
106	508	384	16	1	1/1
147	432	364	16	1	1/1
163	446	216	16	1	1/1
176	320	120	16	1	1/1
177	320	120	16	1	1/1
190	376	120	16	1	1/1
212	446	455	16	1	1/1
246	868	60	16	1	1/1
292	880	454	2,5	1	1/1
316	406	325	2,5	1	1/1



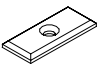

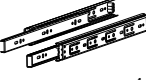

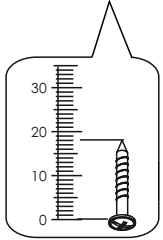
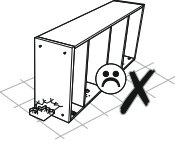
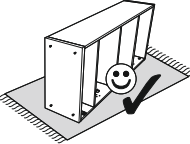
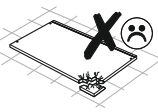
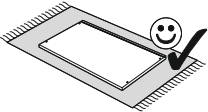
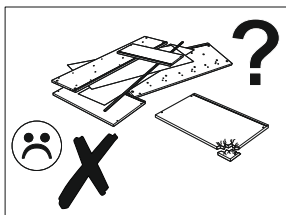
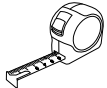
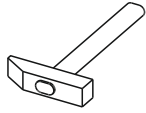
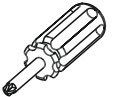
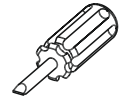
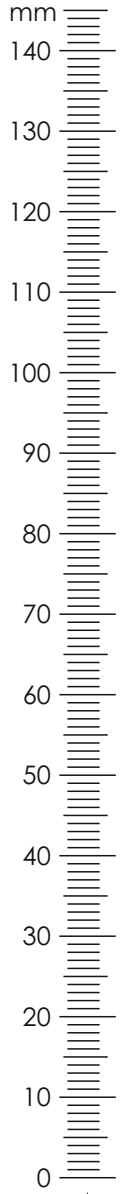
A1  7x34 18	A2  Ø15x12 18	B5  10x50 1	C1  8x35 25
D1-1  2	E1-1  2	H58  2	I  S4 1
N1  5	P5  4	R3  3x20 16	R23  6,3x13 4
R24  7x50 6	R27  5,0x13 10	R32  4x27 4	R102  3,5x16 6
S1  8	S3  2	S5  Ø18 10	U  130x35x15 1
Z10  300 1			



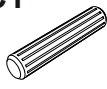



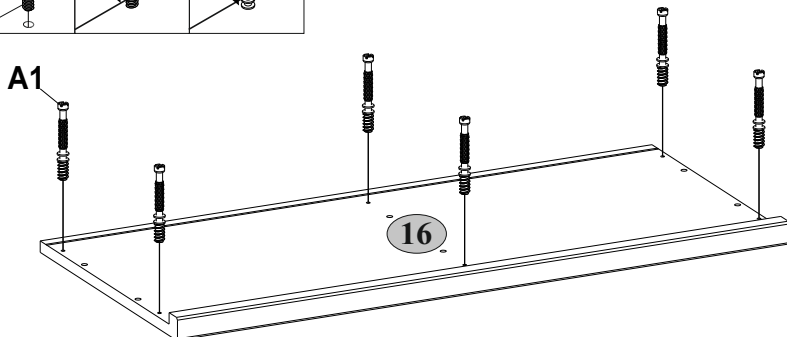
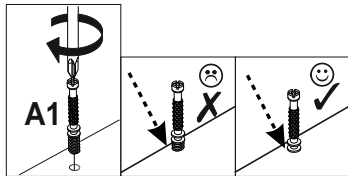
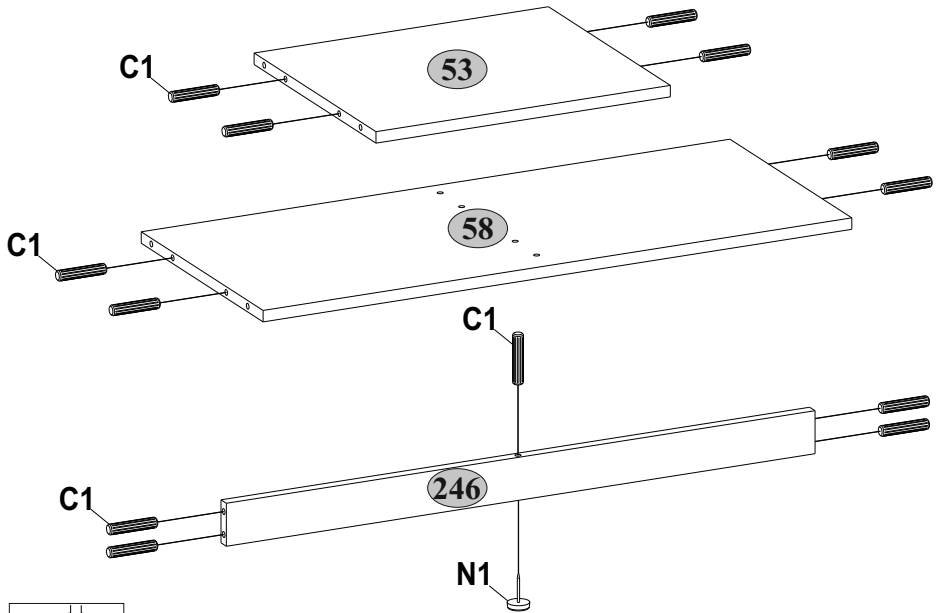
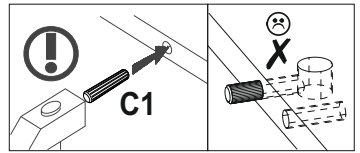

1

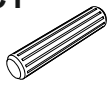
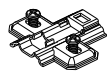
A1  7x34	C1  6 8x35	N1  13	 1
--	--	--	--

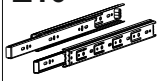

2

A1  7x34 8	C1  8x35 8	D1-1  2	N1  4	P5  4
R23  6,3x13 4	R27  5,0x13 6	Z10  300 1		

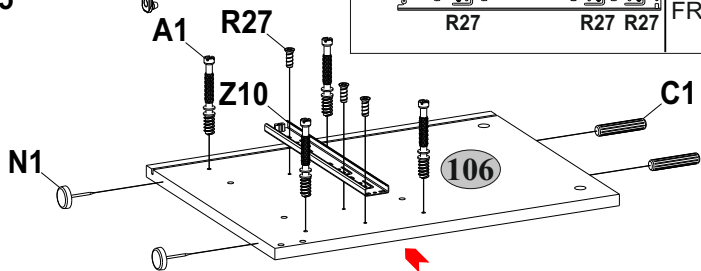
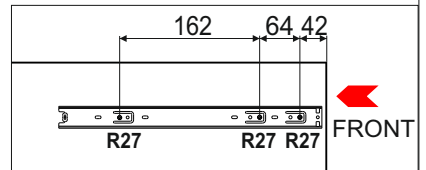
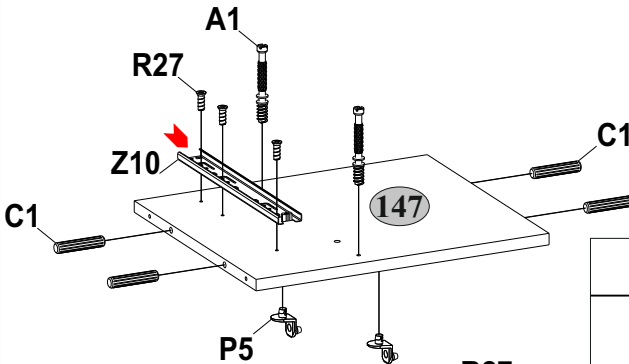
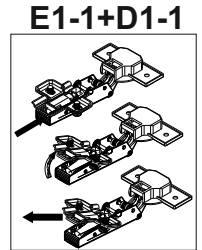
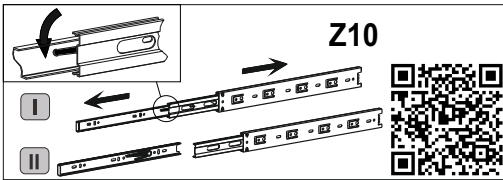
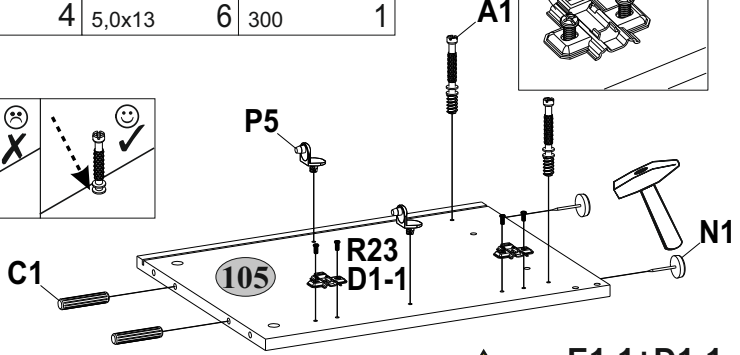
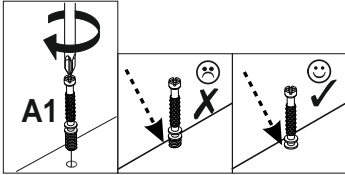

3

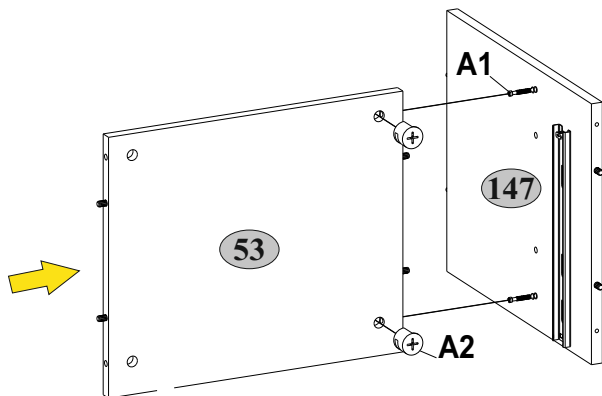
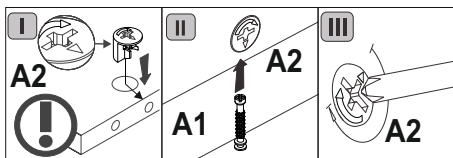
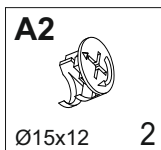

4

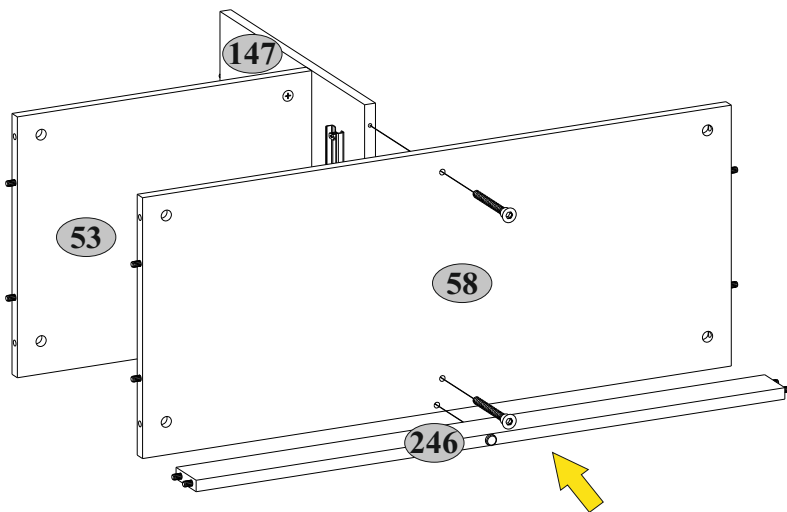
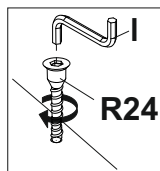
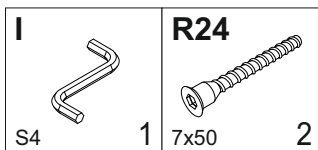

5

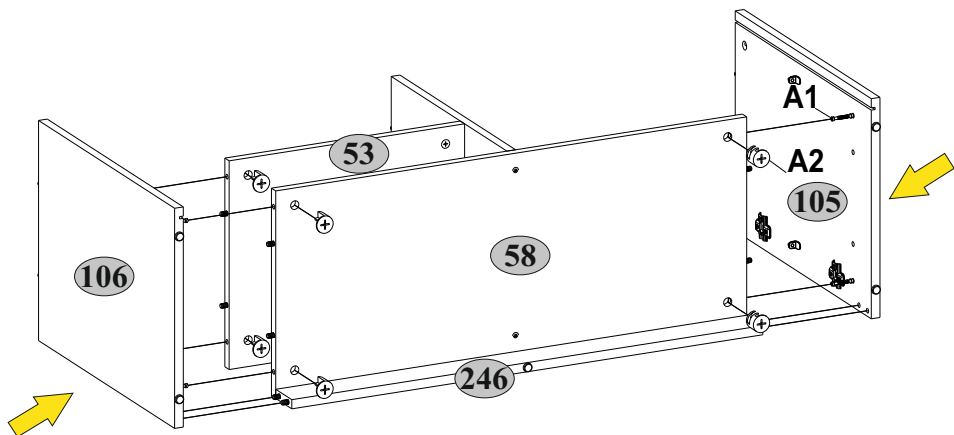
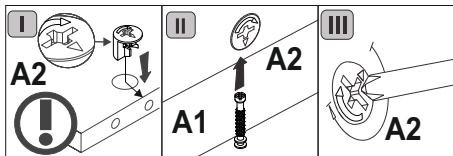
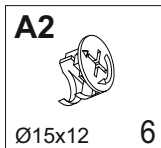

6

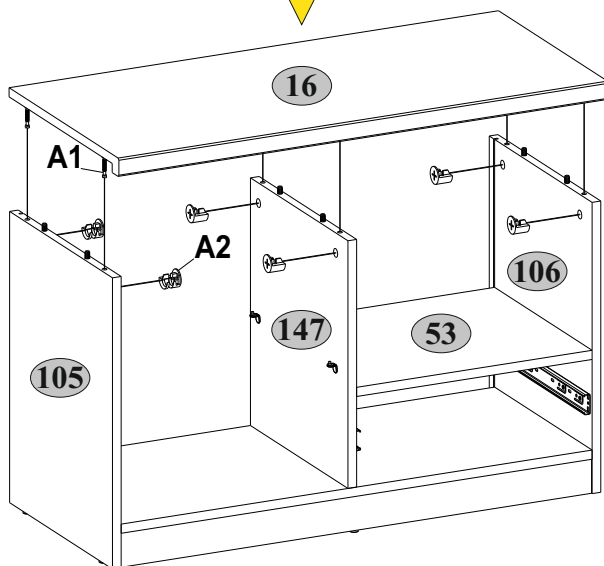
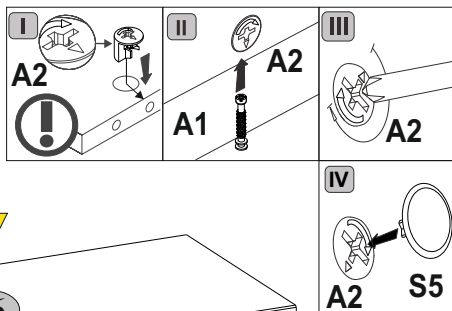
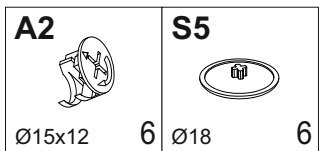

7

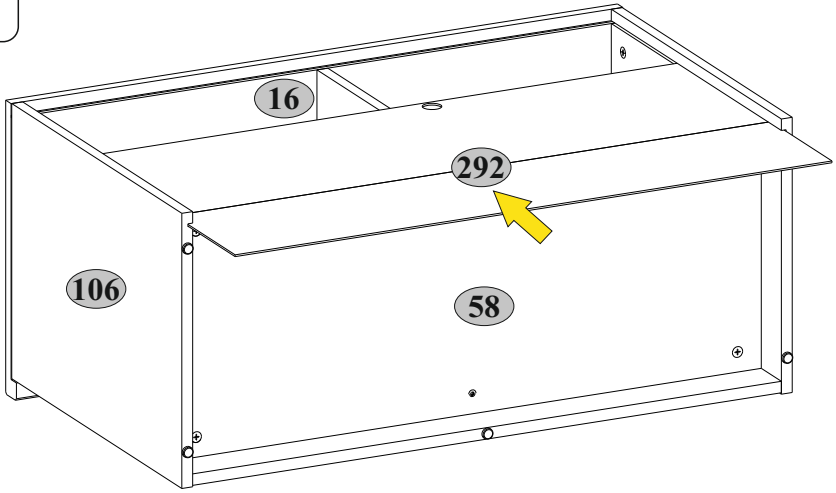

8

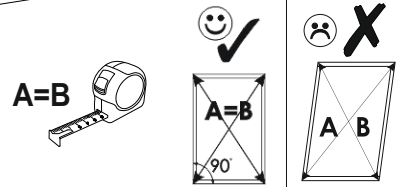
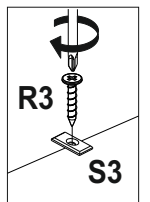
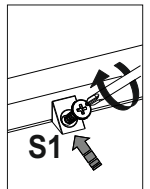
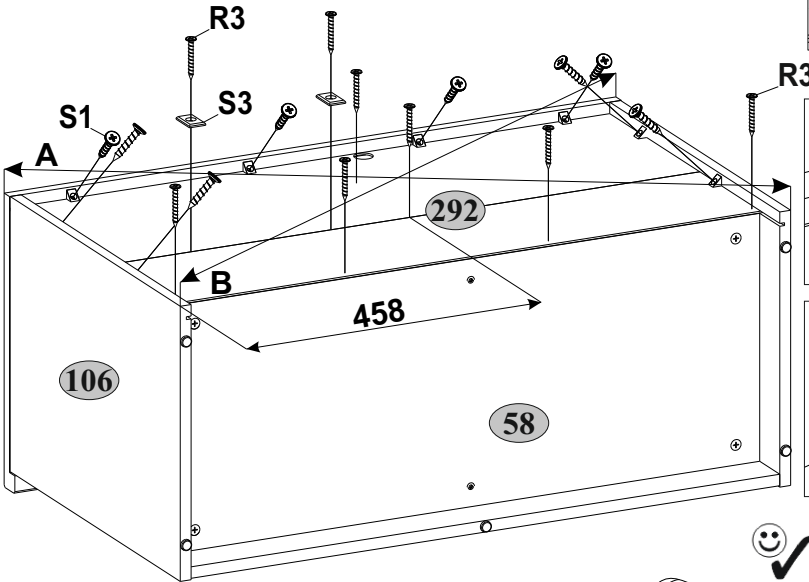
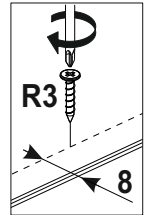
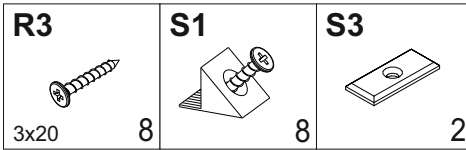

9**B5**

10x50

R102

1

3,5x16

U

2

130x35x15

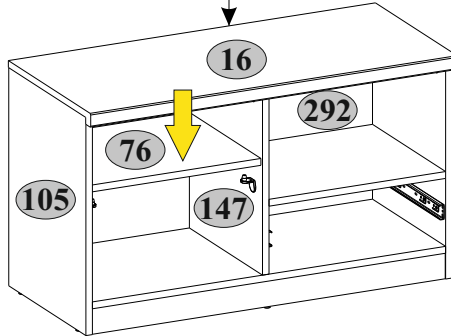
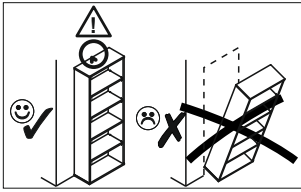
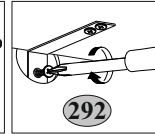
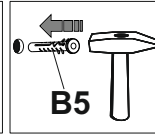
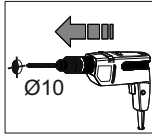
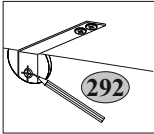
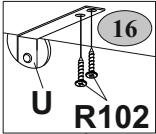
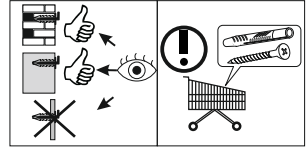
**10****A1**

7x34

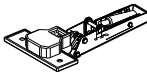
E1-1

4

H58

2

R102

2

3,5x16

R32



4

4x27

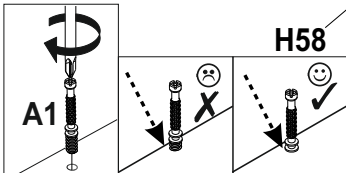
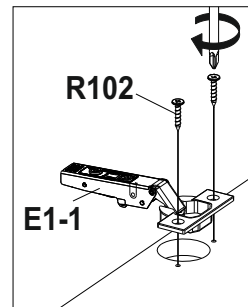
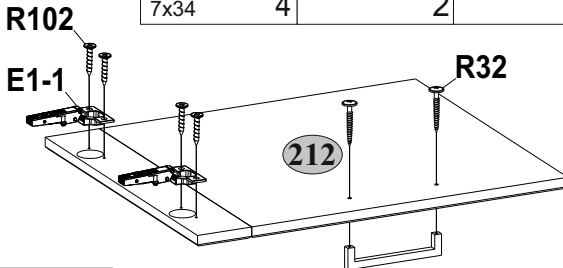
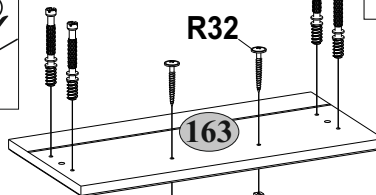

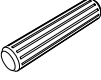

4

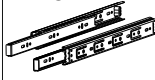
**H58****H58**

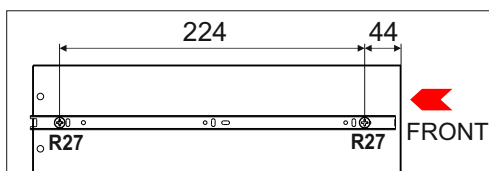
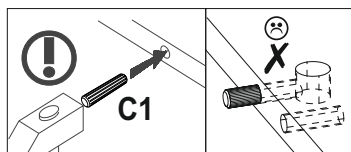
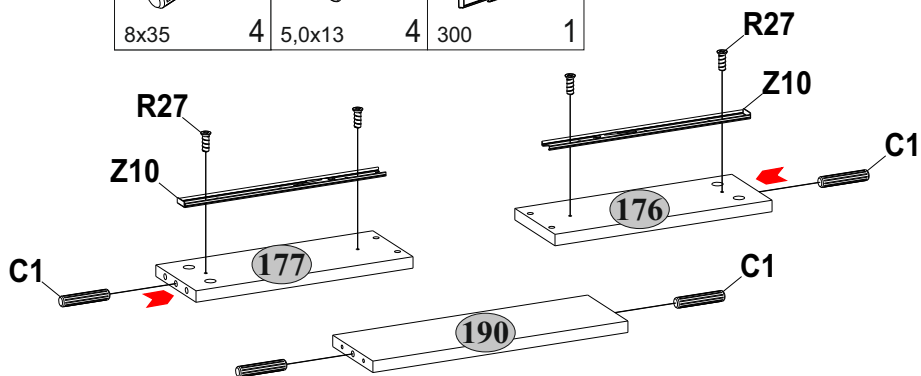
11

C1  8x35	R27  4 5,0x13	Z10  4 300
--	---	--

**12**

A2  Ø15x12	I  4 S4	R24  1 7x50	S5  4 Ø18
--	---	---	---

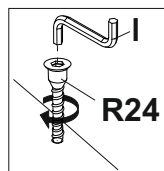
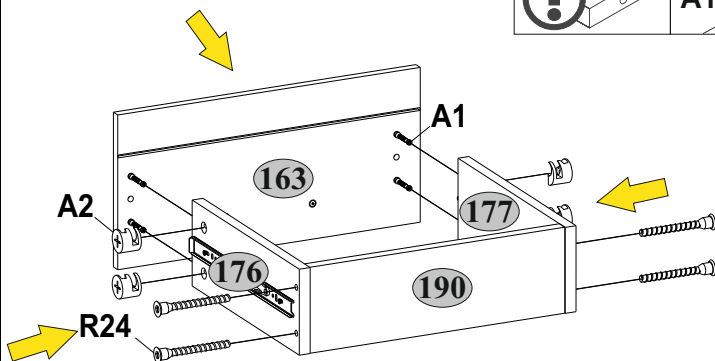
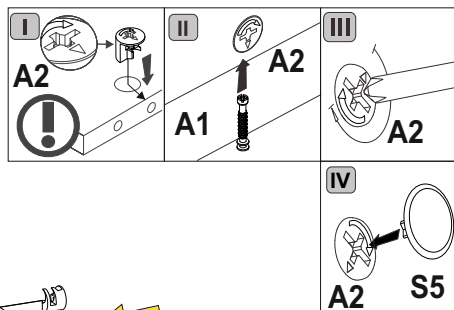

13

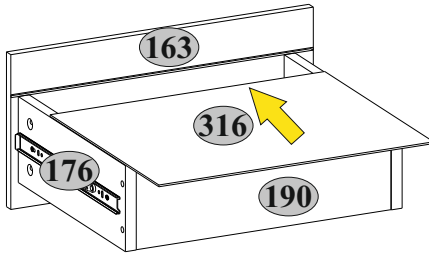

14

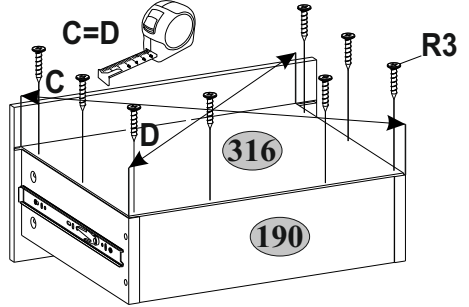
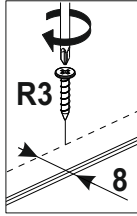
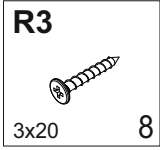

15

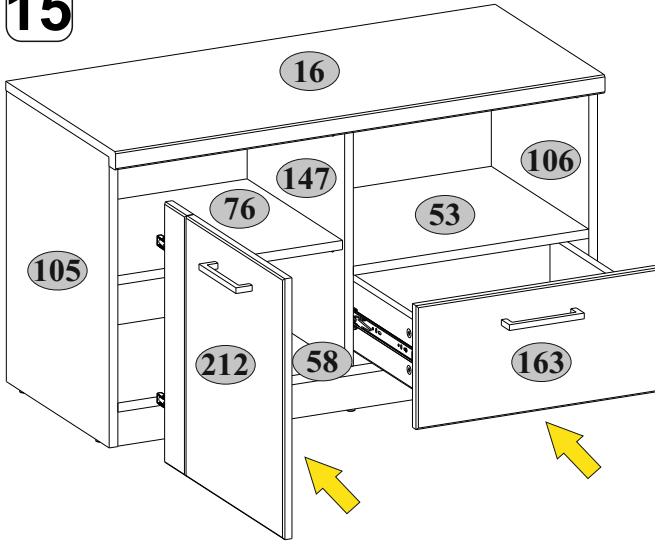

53 76 163  max 5 kg

16 58  max 10 kg

