

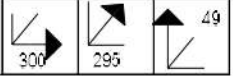

ASSISTANT
AS-033-00



A 4x	B 4x	C 4x	D 8x	E 4x

0h 15min		4	≤ 0,5 kg	5,5 x 125	

ID	ID			
00159	②	49*268*16	2x	1/1
00157	③	49*295*16	2x	1/1

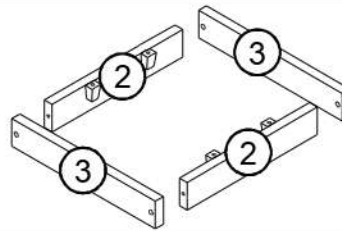

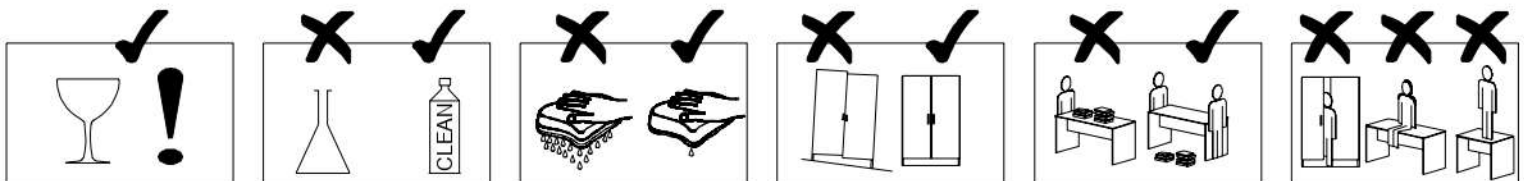
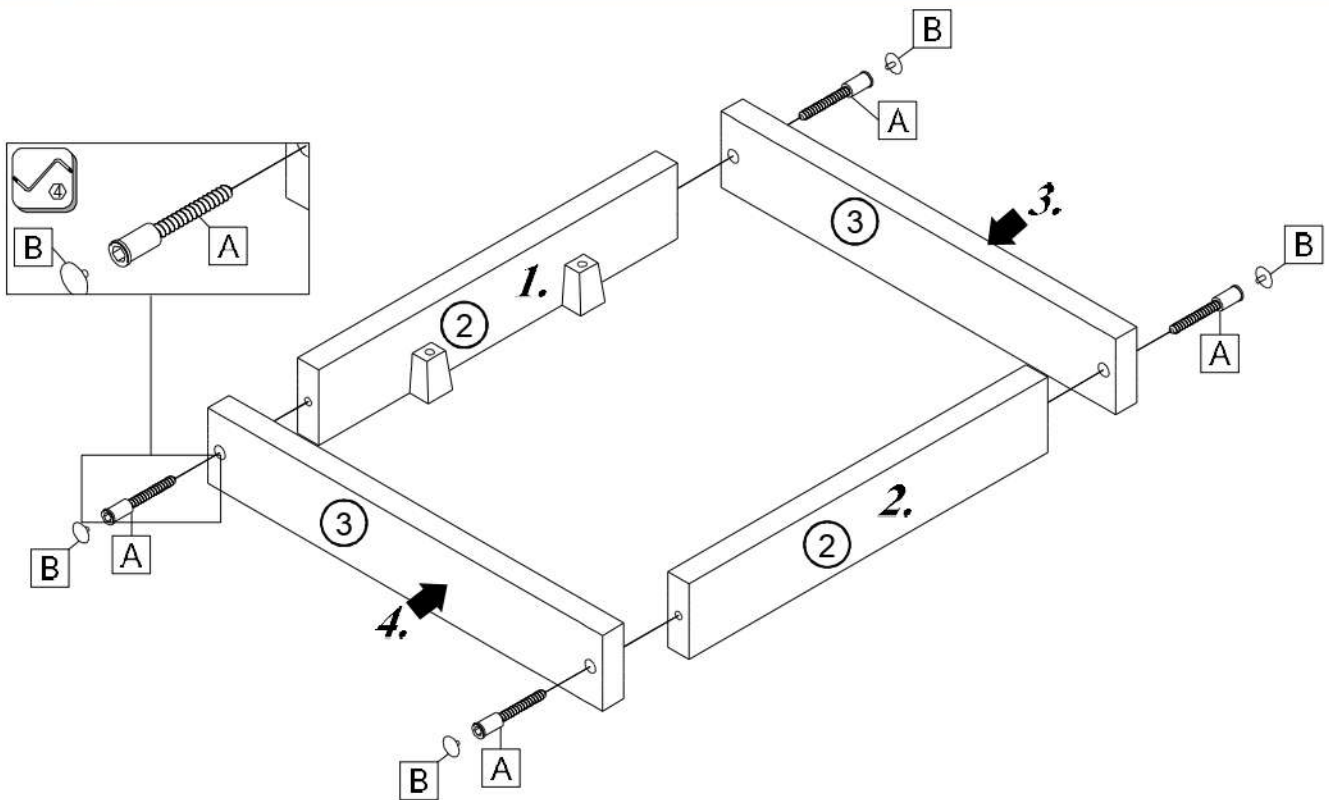

A 4x	B 4x

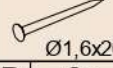

	
C 4x	D 8x

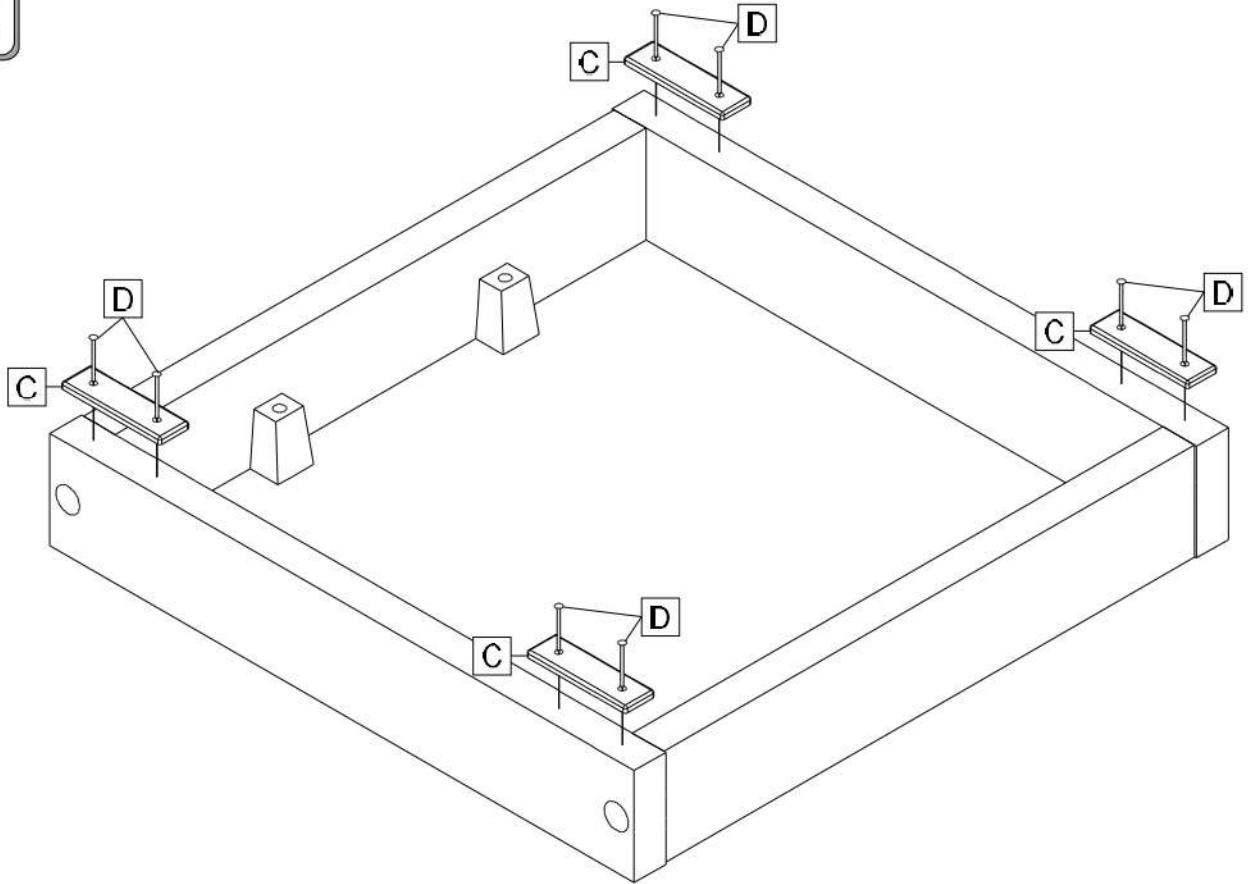
5.



E 4x

