

1126

401

840

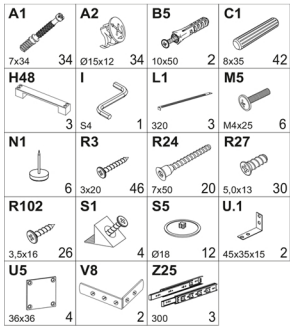

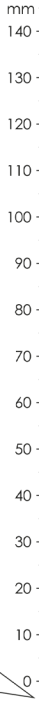
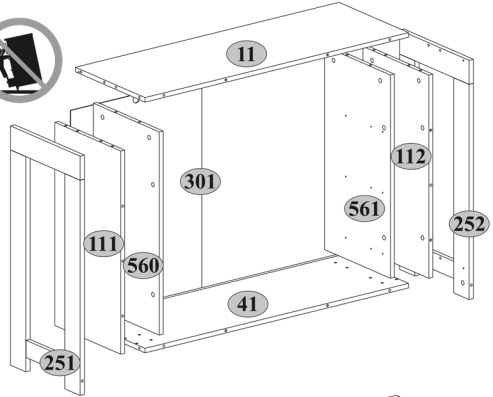
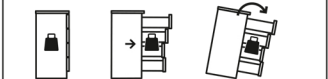
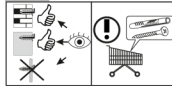
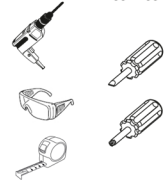
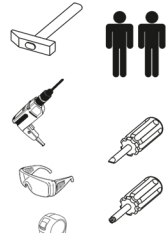
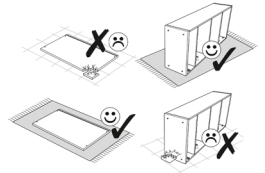
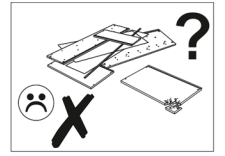
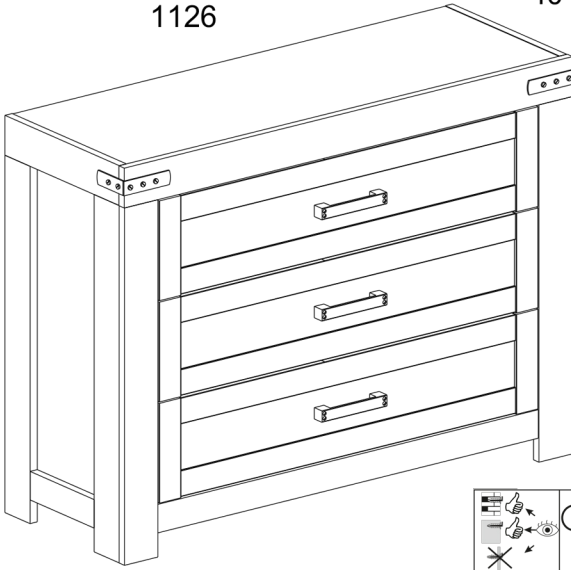

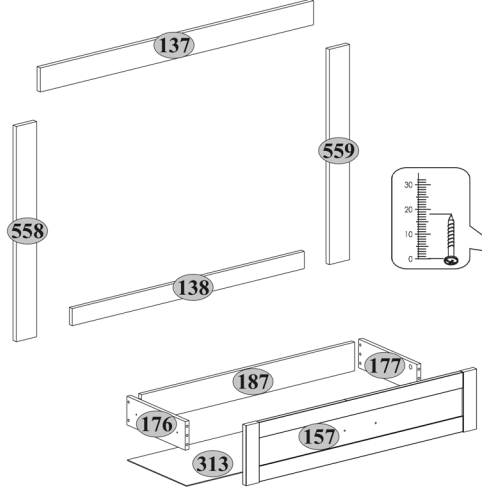
	mm	mm	mm		
11	1088	382	16	1	2/2
41	1088	362	16	1	2/2
111	710	362	16	1	1/2
112	710	362	16	1	1/2
137	1126	84	18	1	2/2
138	957	60	16	1	2/2
157	952	210	19	3	2/2
176	320	100	16	3	1/2
177	320	100	16	3	1/2
187	880	100	16	3	2/2
251	836	382	18	1	1/2
252	836	382	18	1	1/2
301	732	1082	2,5	1	1/2
313	910	325	2,5	3	2/2
558	752	84	18	1	2/2
559	752	84	18	1	2/2
560	710	362	16	1	1/2
561	710	362	16	1	1/2



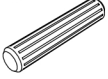

x3

1

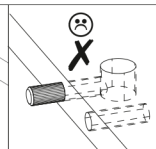
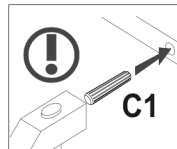
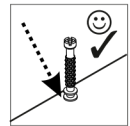
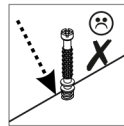
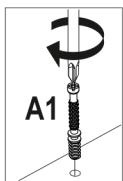
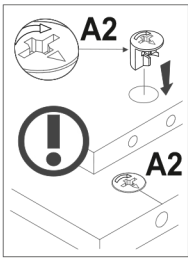
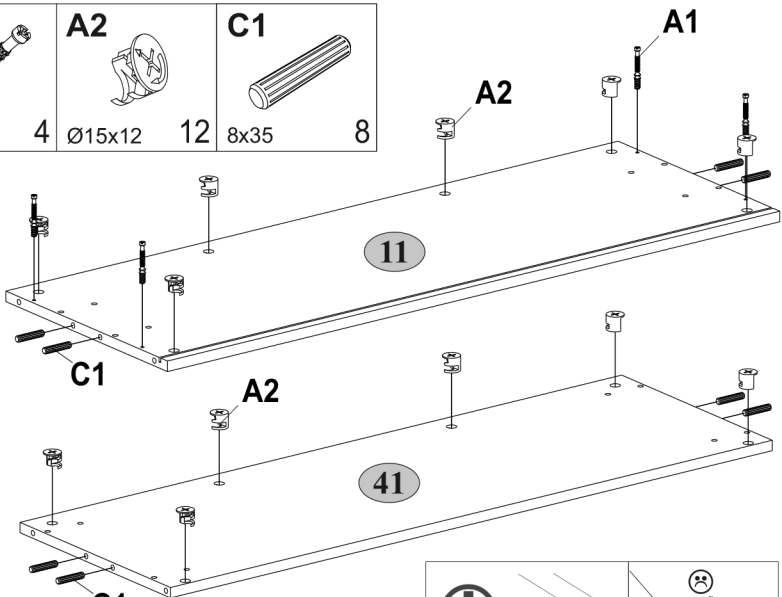
A1  7x34	A2  4 Ø15x12	C1  12 8x35	8
---	---	--	----------

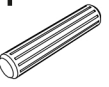

2

C1  8x35	R27  5,0x13	Z25  300	2
--	---	--	----------

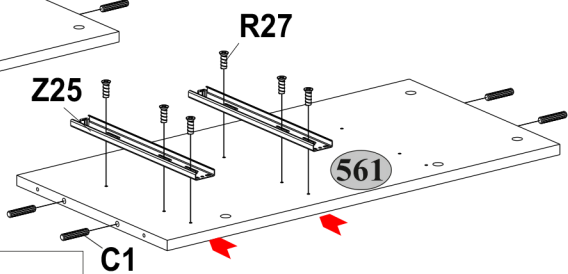
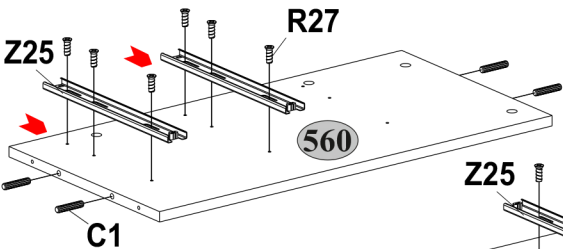
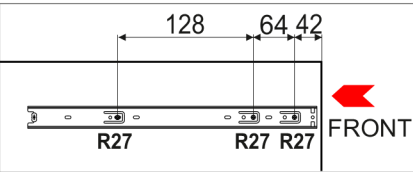

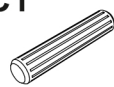

3

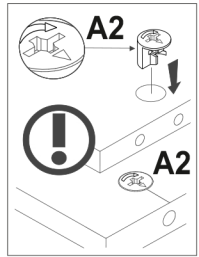
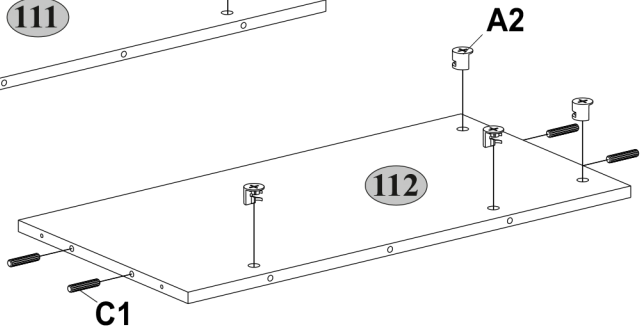
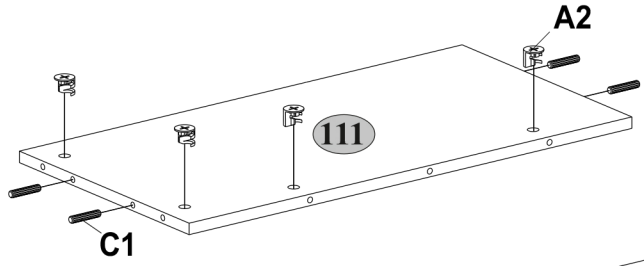
A2 	C1 
Ø15x12 8	8x35 8

4

A1 	A2 
7x34 8	Ø15x12 2

5**A1**

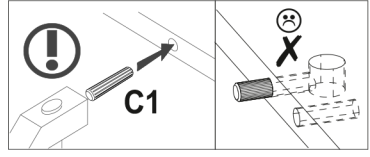
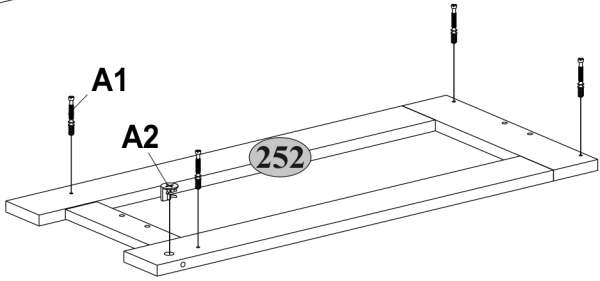
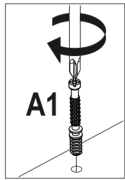
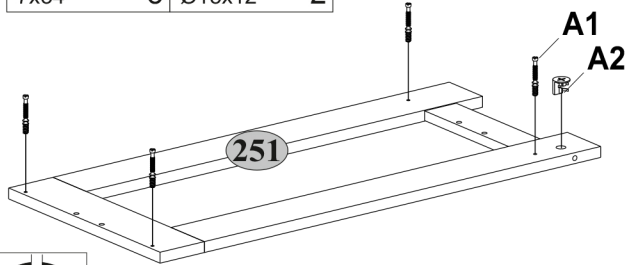
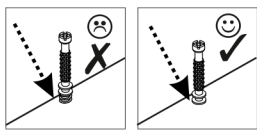
7x34

10

R102

3,5x16

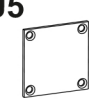
U5

16

36x36

4

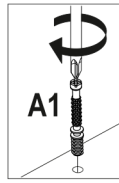
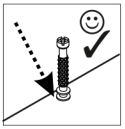
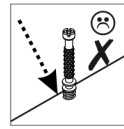
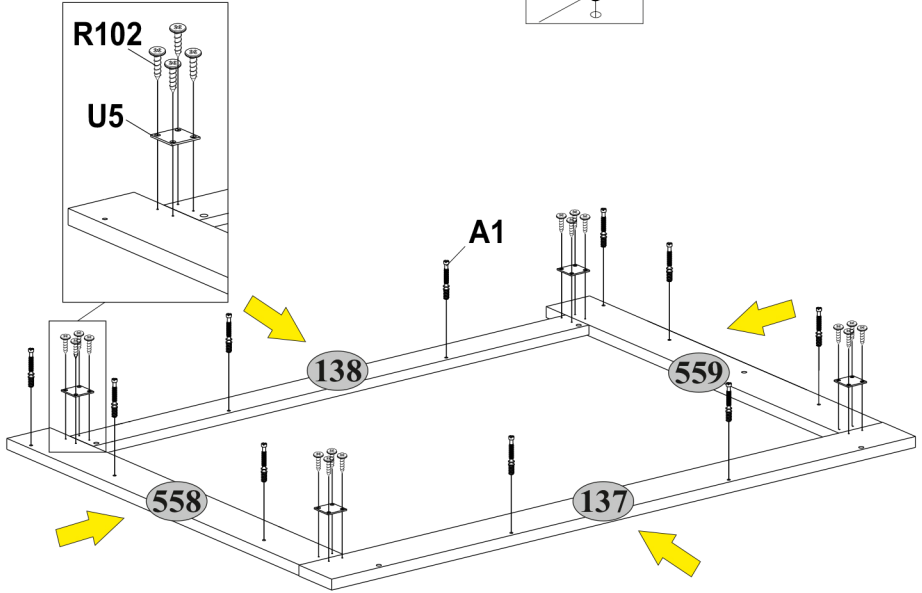
**A1****R102****U5****6****I**

S4

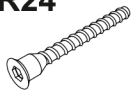
R24

1

7x50

8

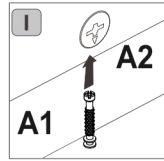
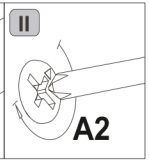
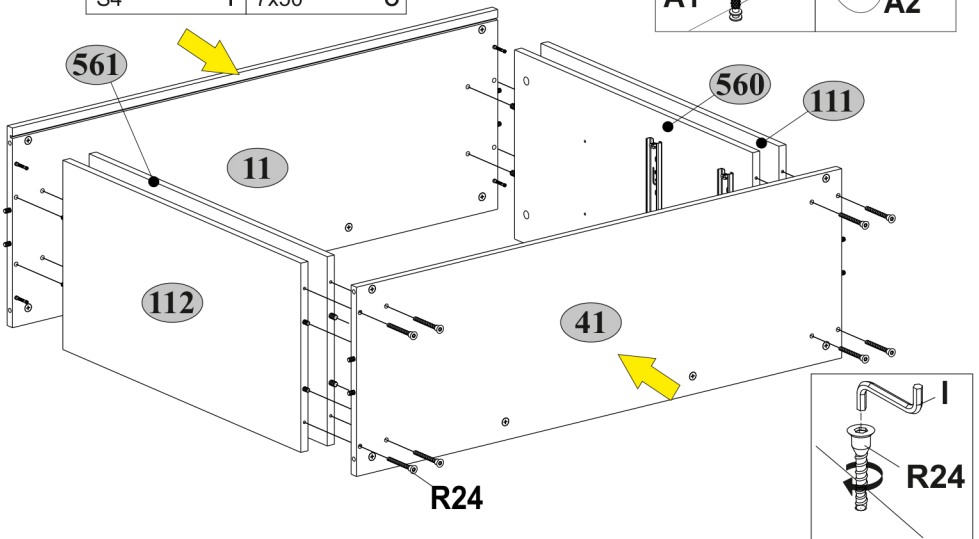
**A1****A2**

7

R3



3x20

S1

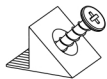

16

4

I

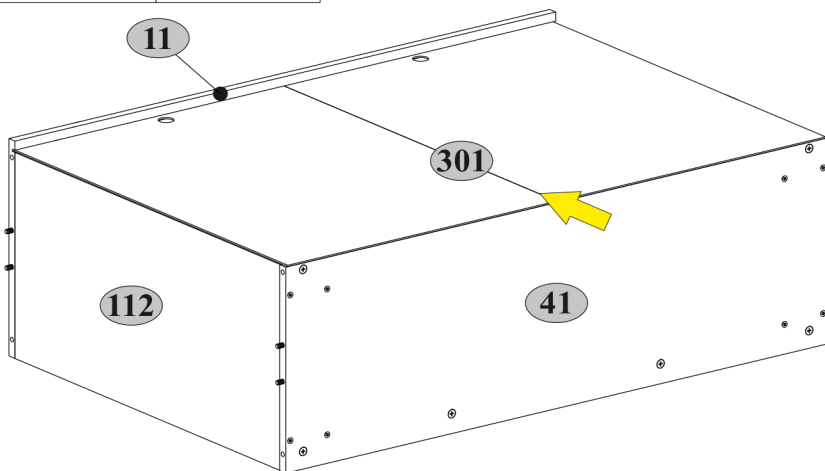

II

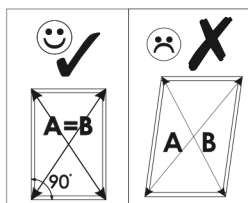

A=B

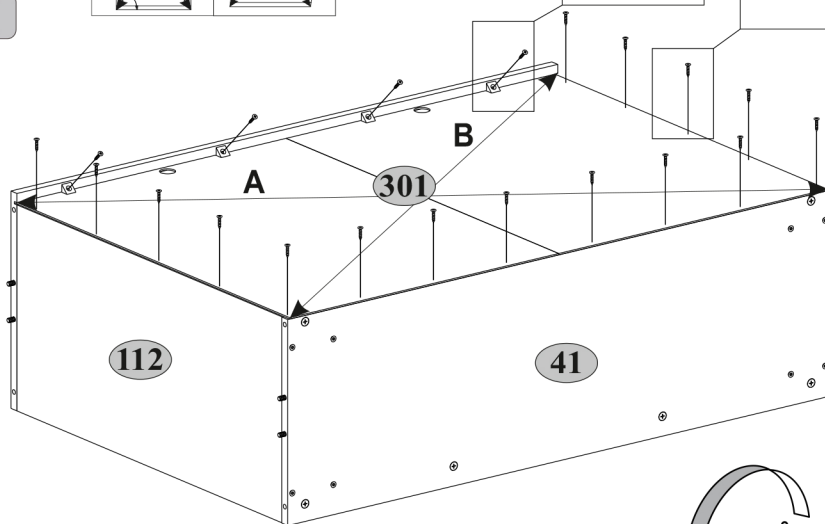
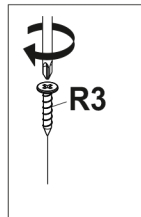
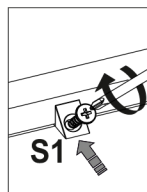
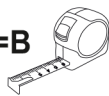

180°

8

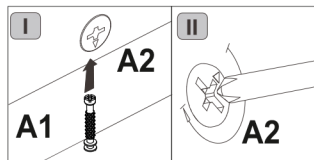
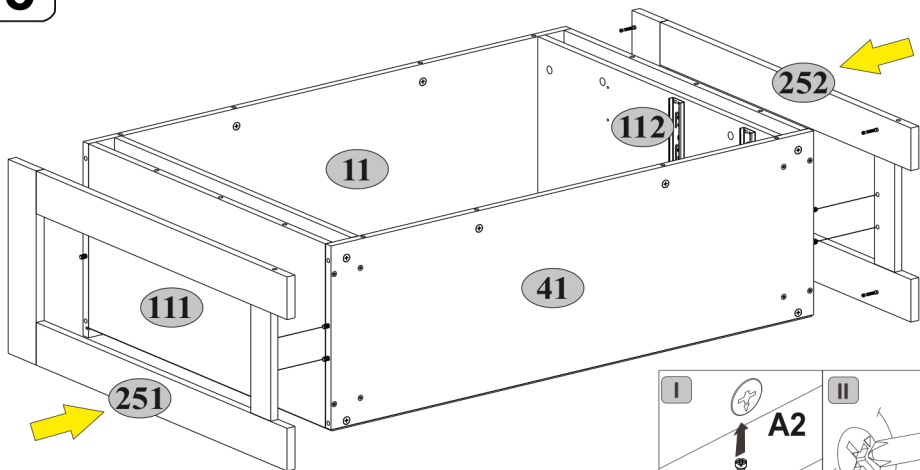

9

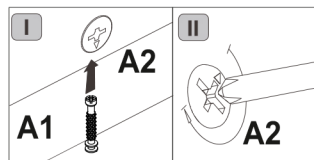
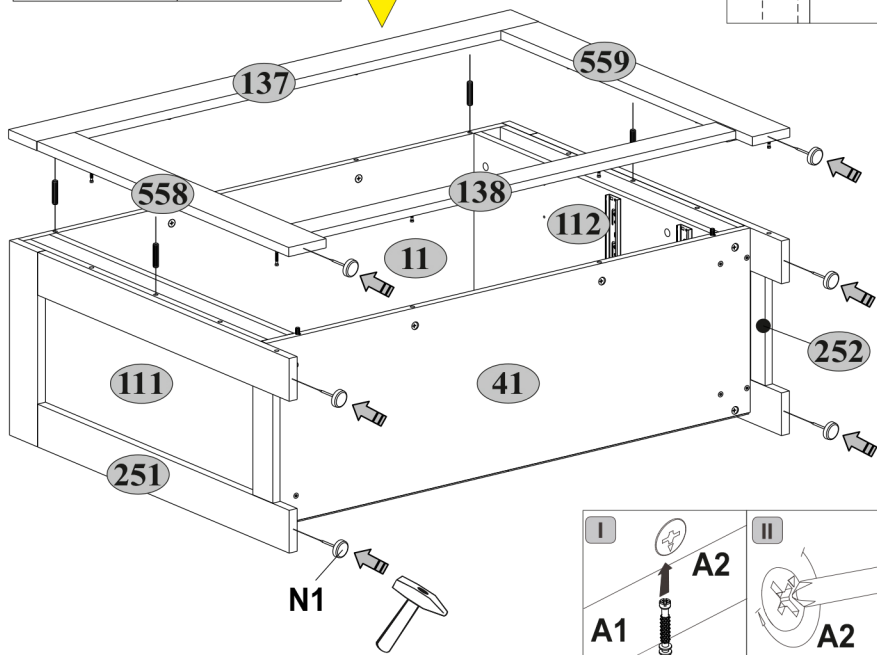
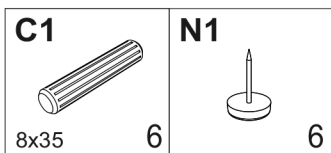

10

R27



5,0x13

Z25



6 300

1

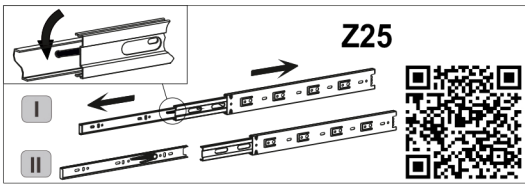
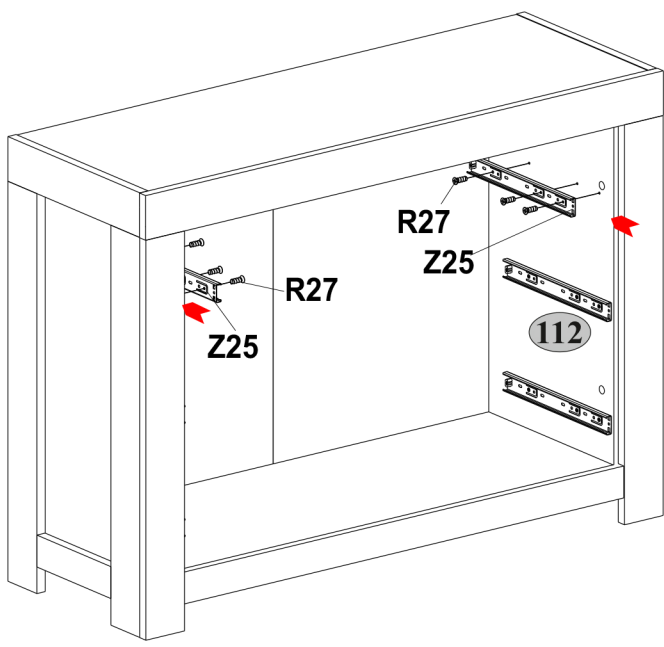
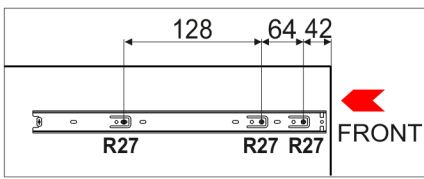

11**B5**

10x50

2

R102

3,5x16

4

U.1

45x35x15

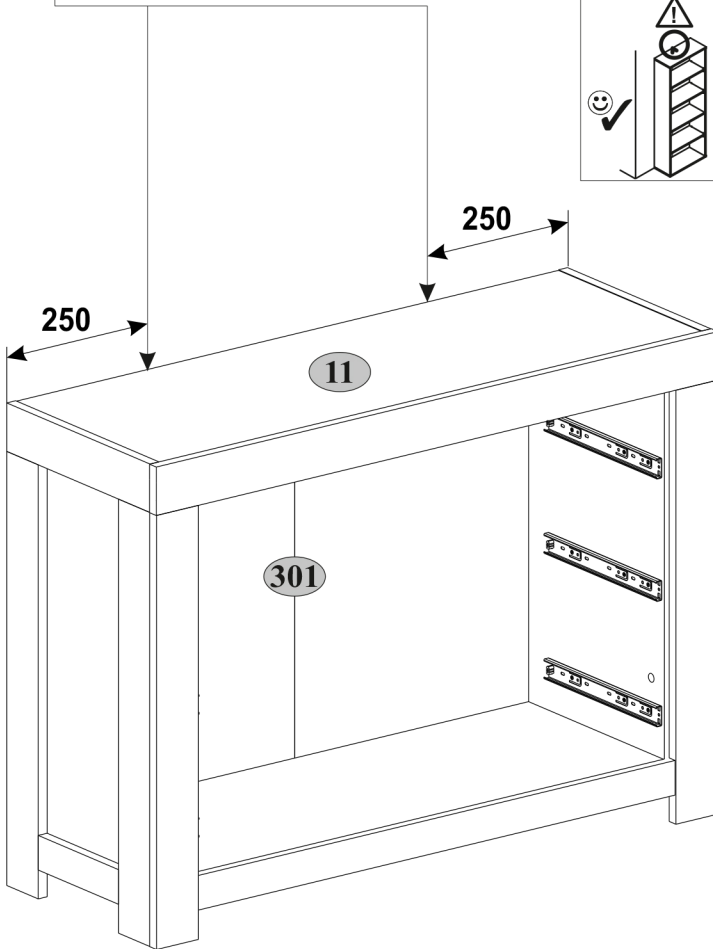
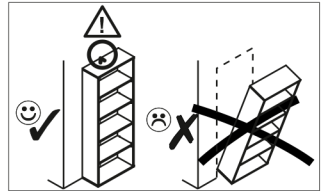
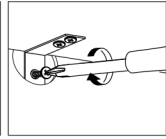
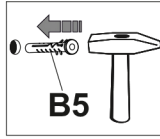
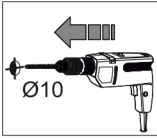
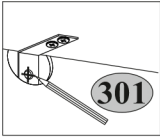
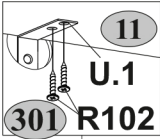

2

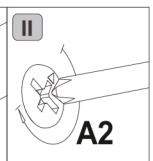
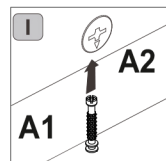
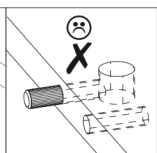
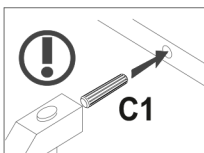
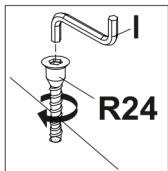
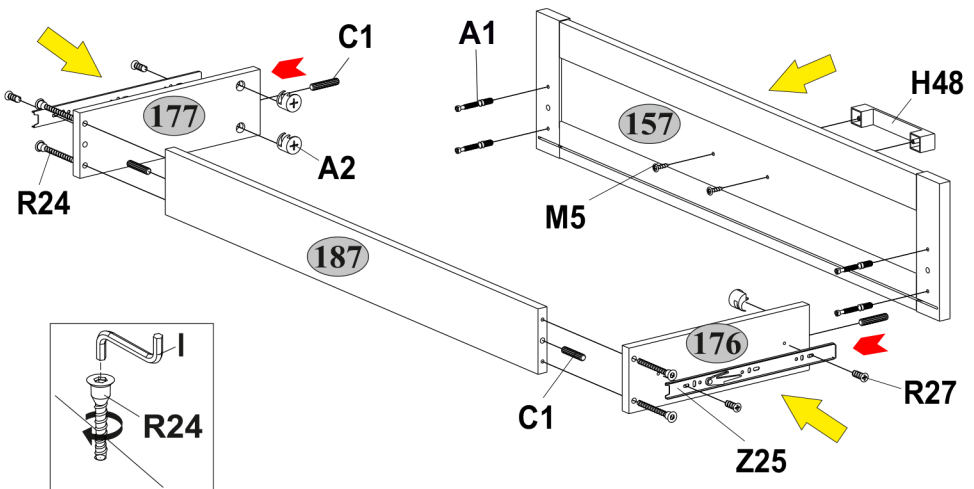
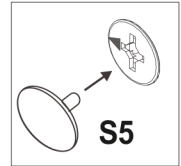
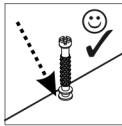
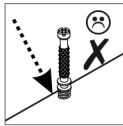
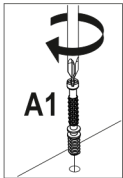
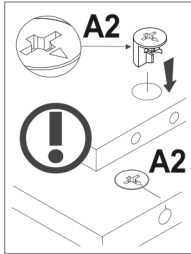
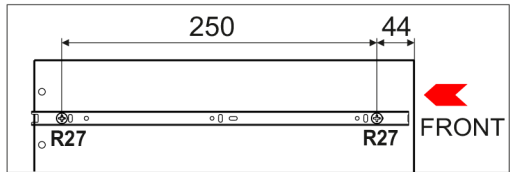
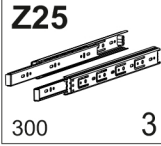
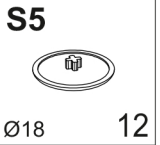
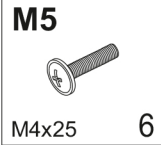
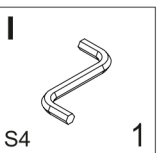
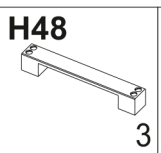
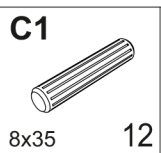
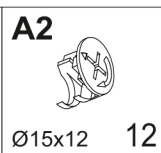
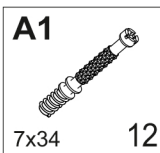

12
x3



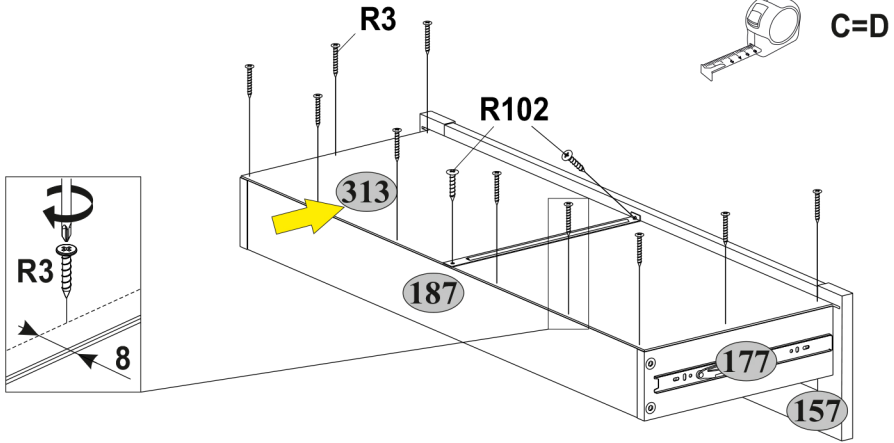
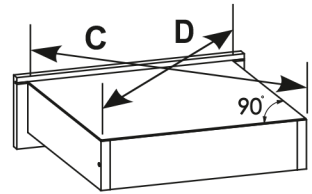

13
x3

L1  320 3	R3  3x20 30	R102  3,5x16 6
--	--	---

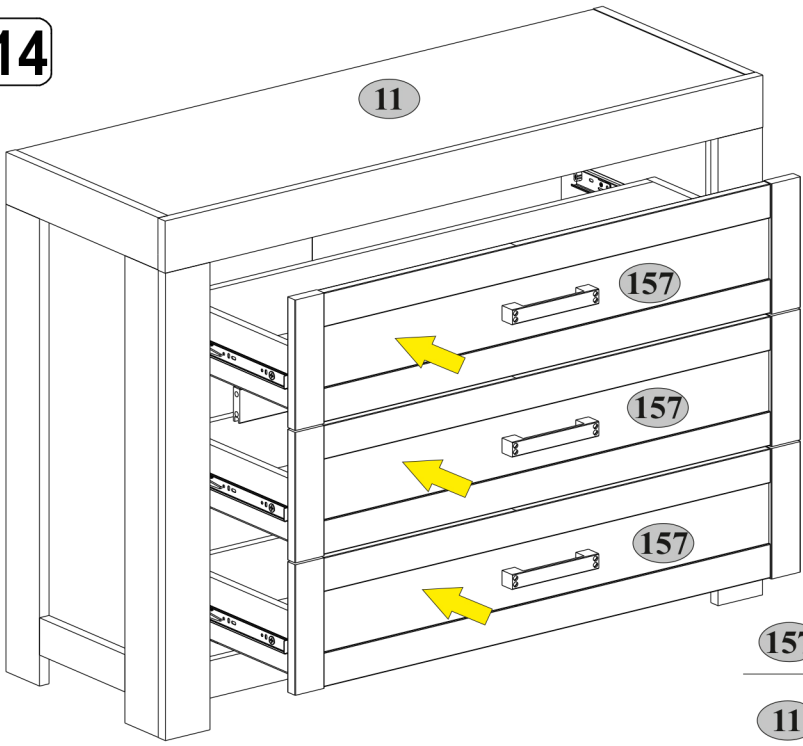

14



- 157**  max. 5 kg
- 11**  max. 15 kg

15

V8

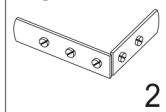

1

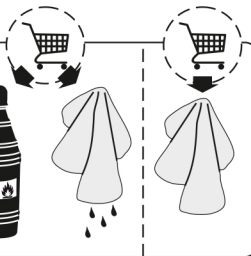

2



!

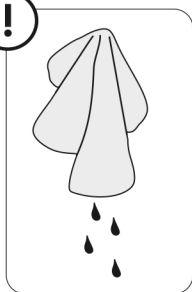

3

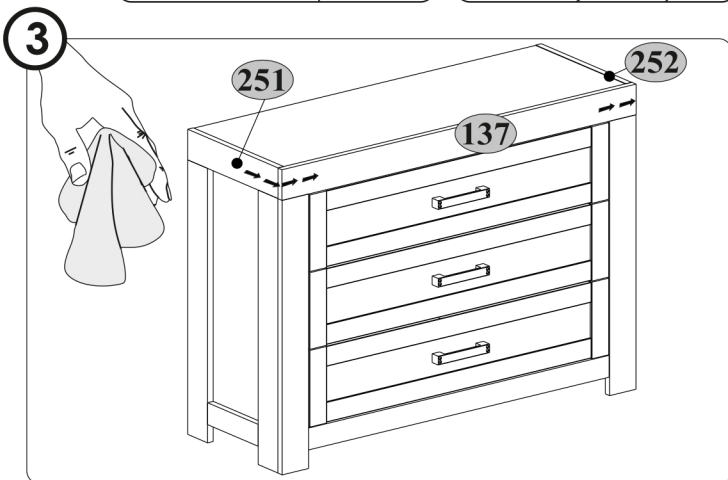

4

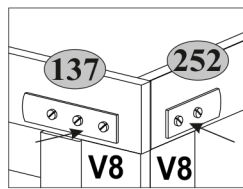
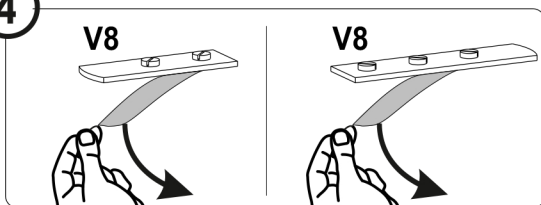

5

