

VILGO

Typ Z2

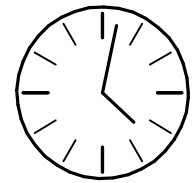

60 min

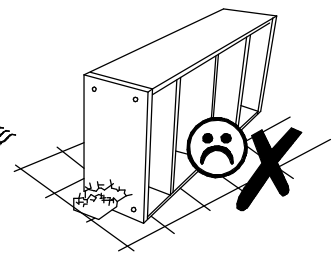
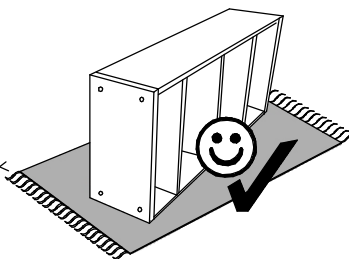
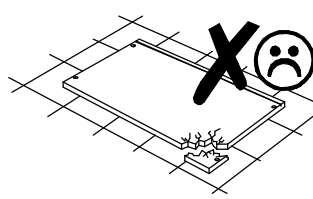
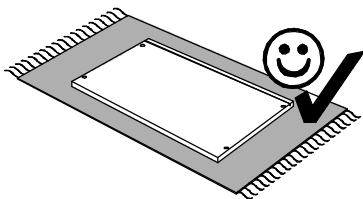
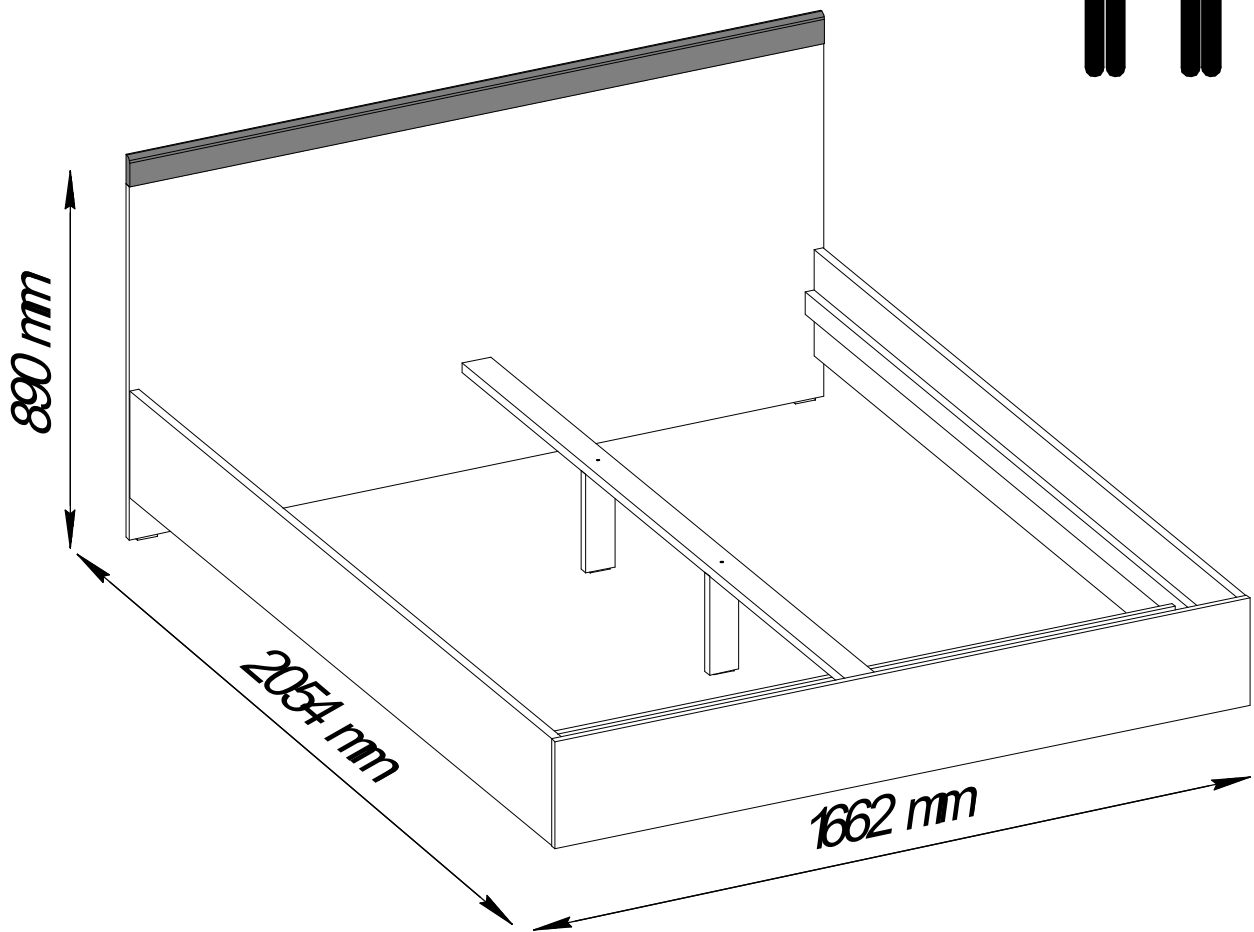
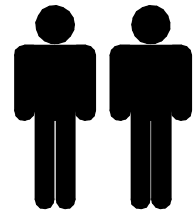

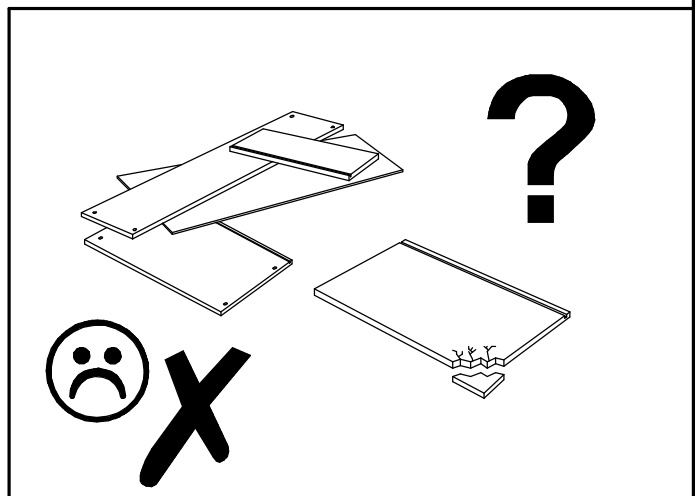
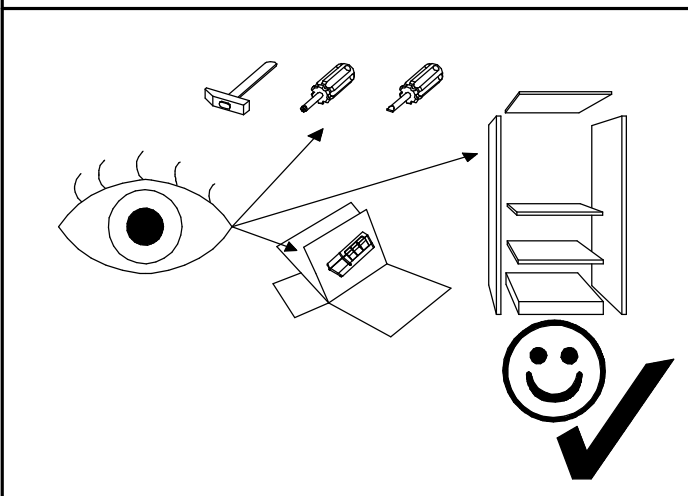
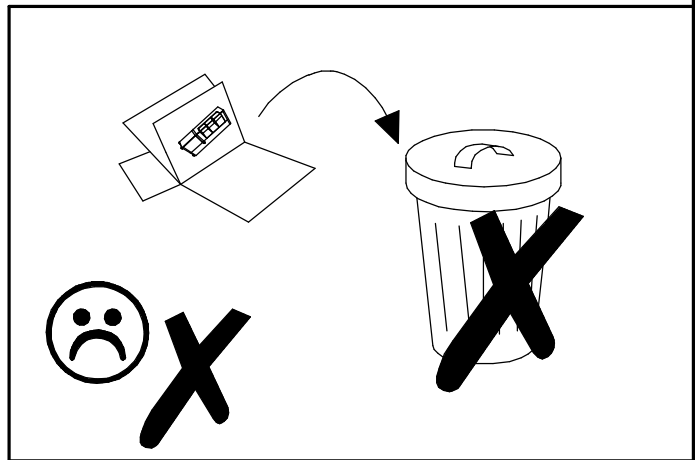
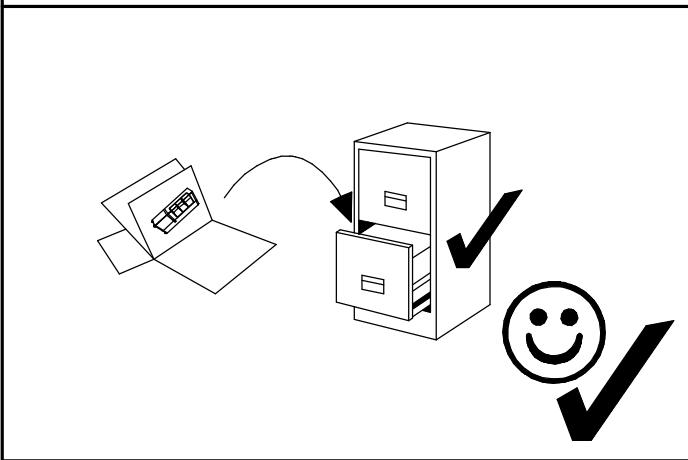
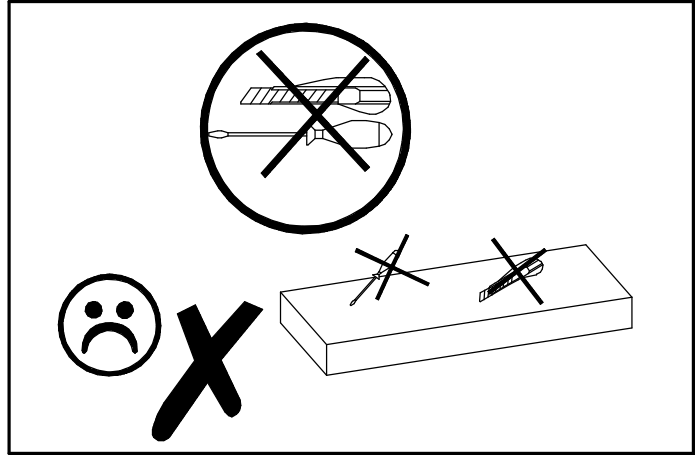
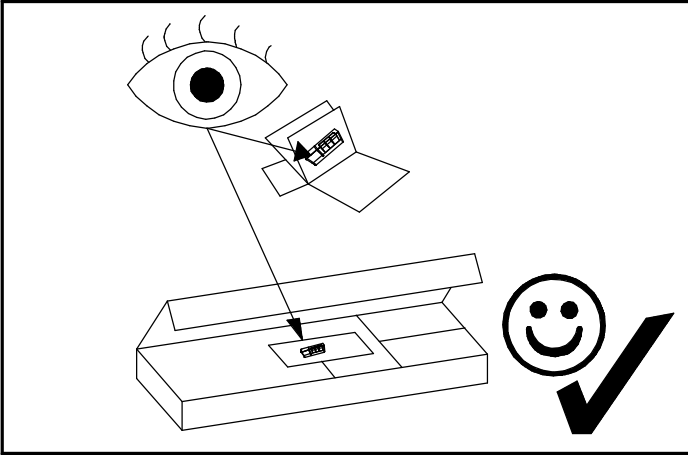

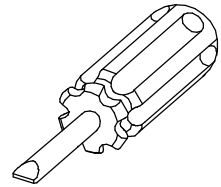
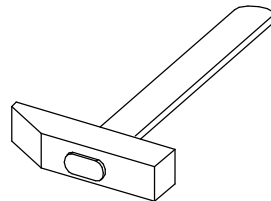
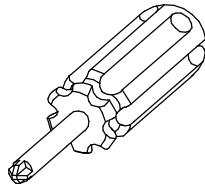
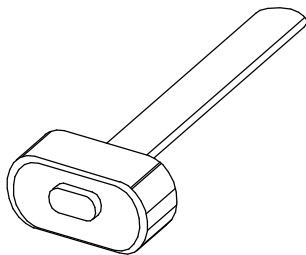
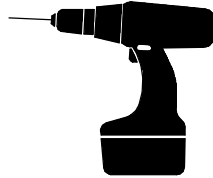
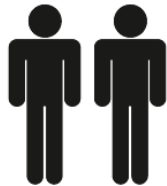
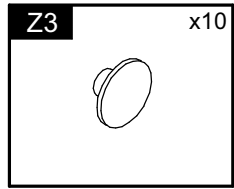
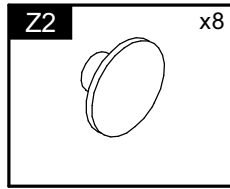
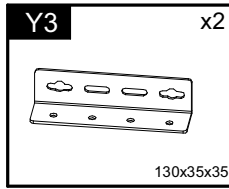
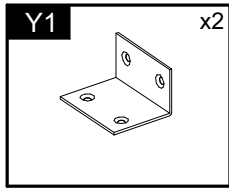
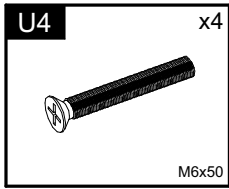
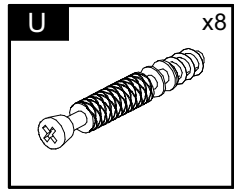
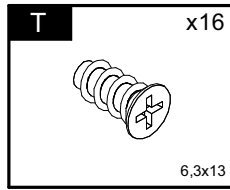
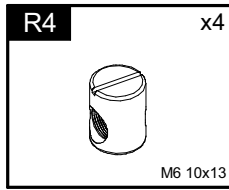
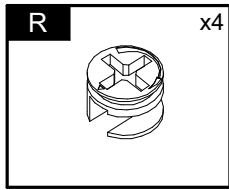
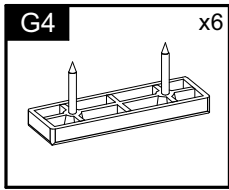
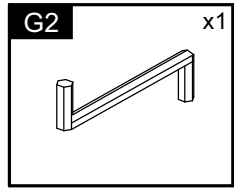
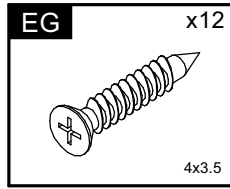
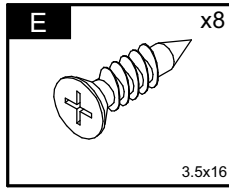
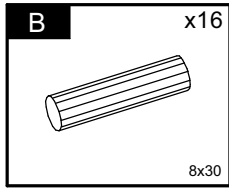
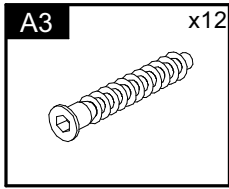
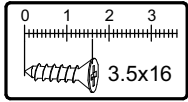
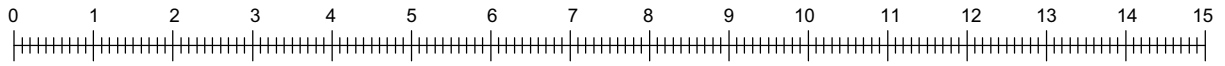

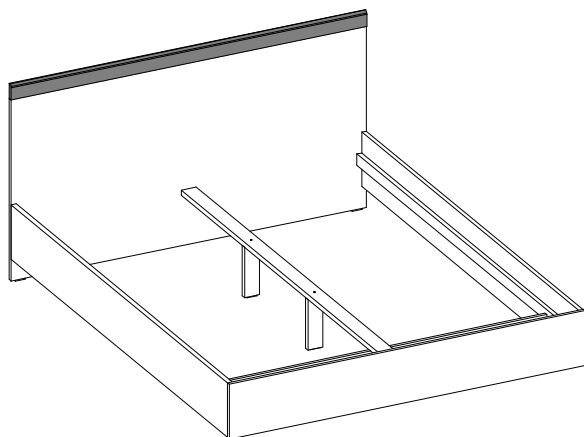

| | | | | | | |
|----|------|------|----|---|-----------|-----|
| | | | | | | |
| 1 | 2016 | 250 | 22 | 1 | 1004 | 1/2 |
| 2 | 2016 | 250 | 22 | 1 | 1013 | 1/2 |
| 3 | 1663 | 252 | 22 | 1 | 1014 | 1/2 |
| 4 | 232 | 70 | 22 | 1 | 1006 | 1/2 |
| 5 | 232 | 70 | 22 | 1 | 1007 | 1/2 |
| 6 | 1662 | 830 | 16 | 1 | 1003 | 2/2 |
| 7 | 1616 | 232 | 16 | 1 | 1005_v | 1/2 |
| 8 | 250 | 130 | 16 | 1 | 1008 | 1/2 |
| 9 | 250 | 130 | 16 | 1 | 1009 | 1/2 |
| 10 | 2016 | 70 | 22 | 1 | 1011 | 1/2 |
| 11 | 1976 | 55 | 22 | 1 | 1010 | 1/2 |
| 12 | 1976 | 55 | 22 | 1 | 1012 | 1/2 |
| 13 | 1664 | 56.5 | 16 | 1 | 1033/3001 | 1/2 |

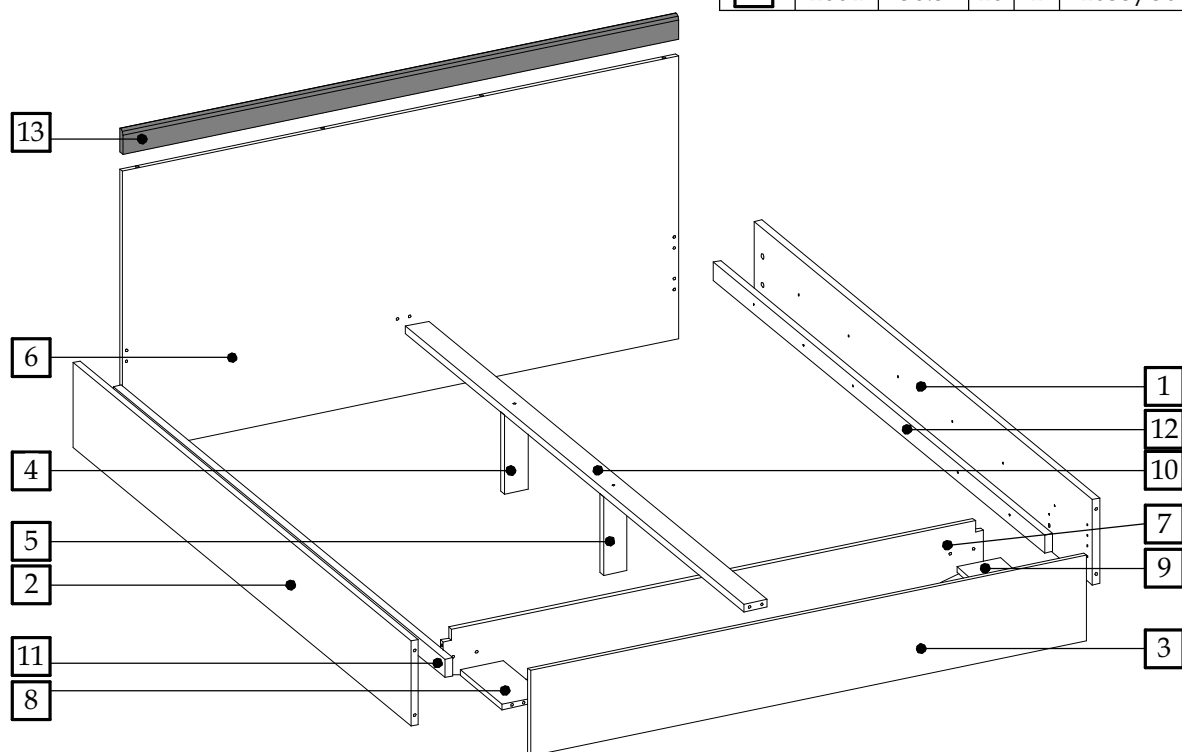

2

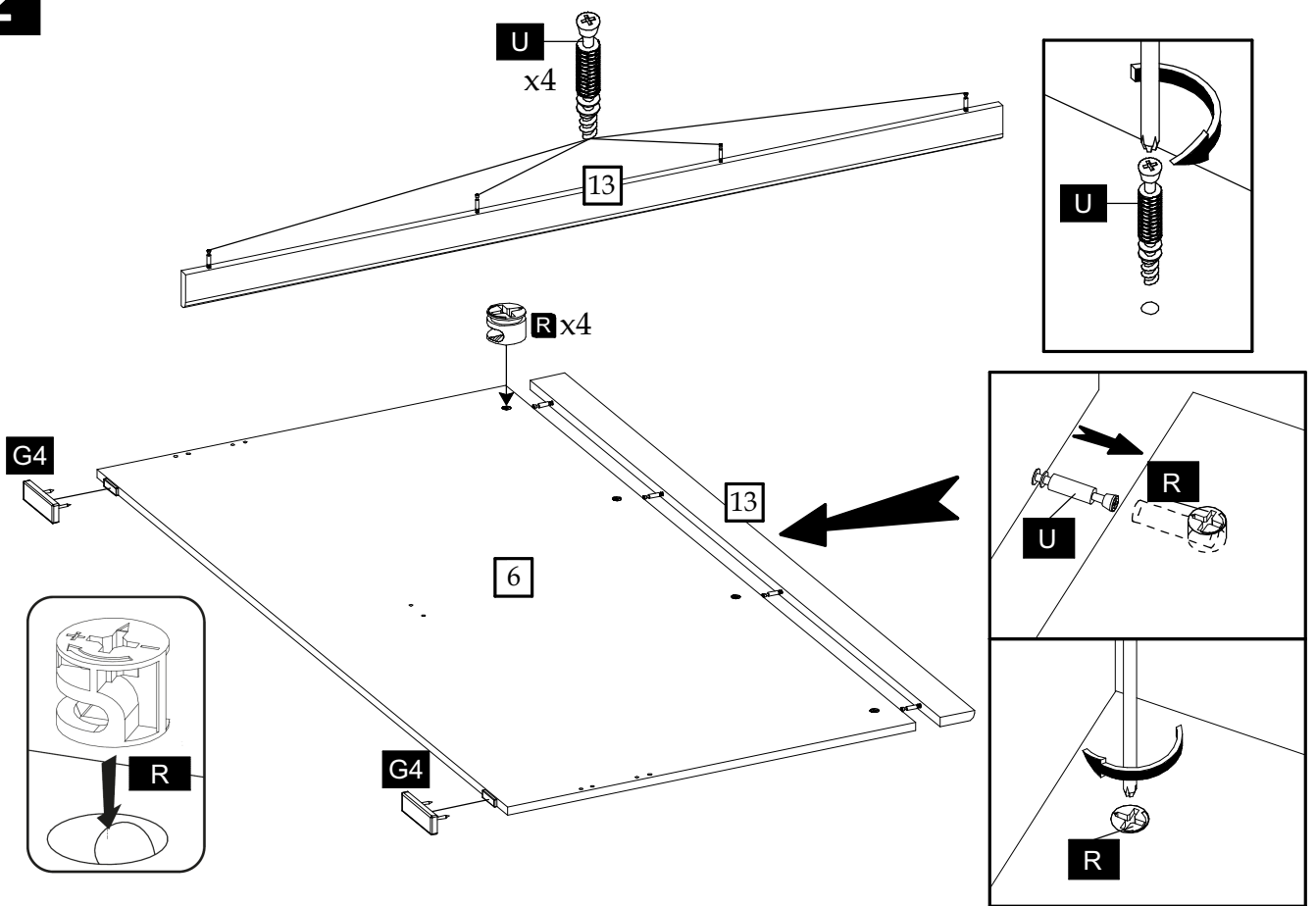

3

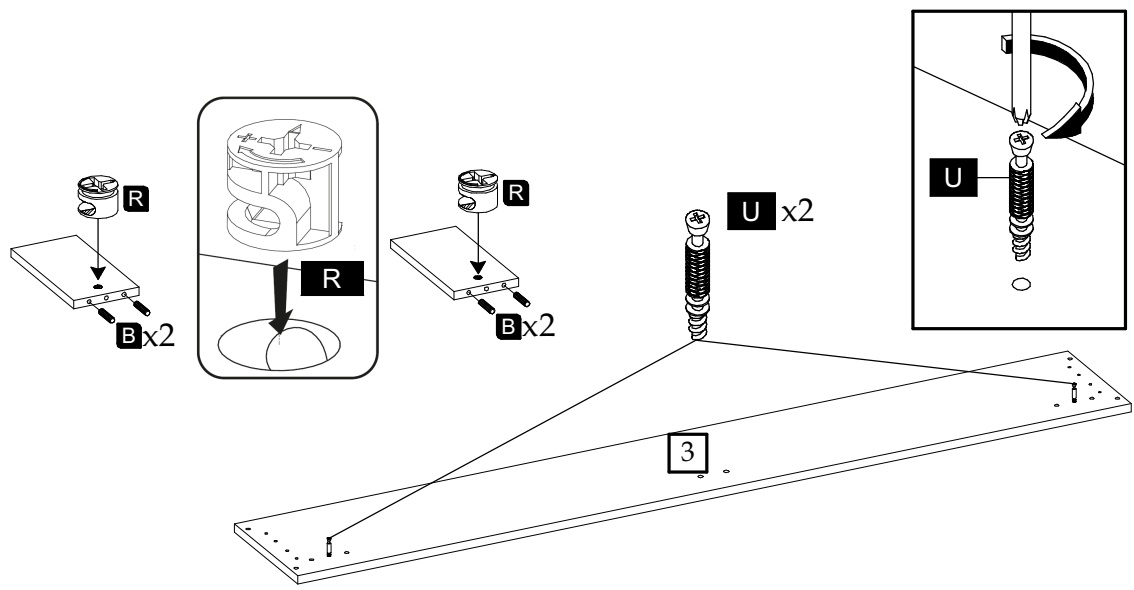

4

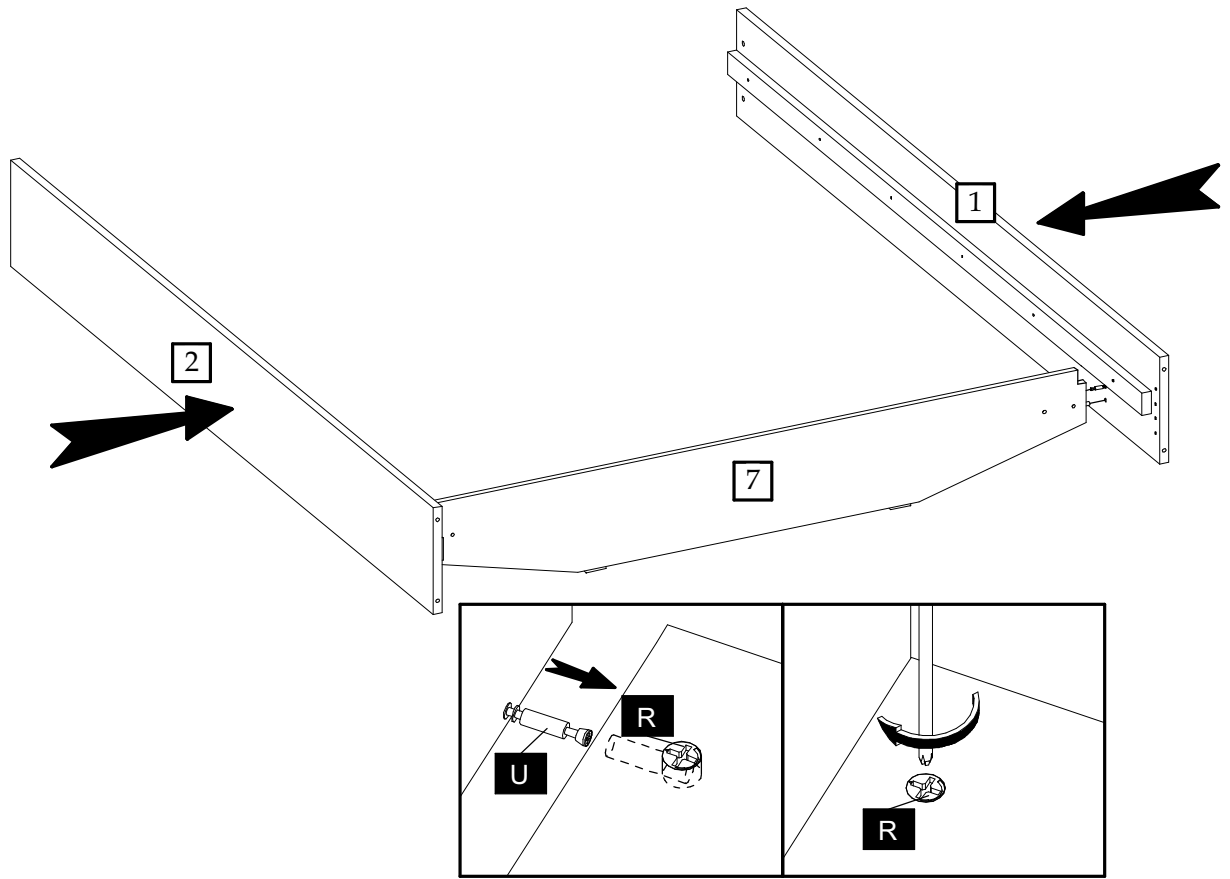

5

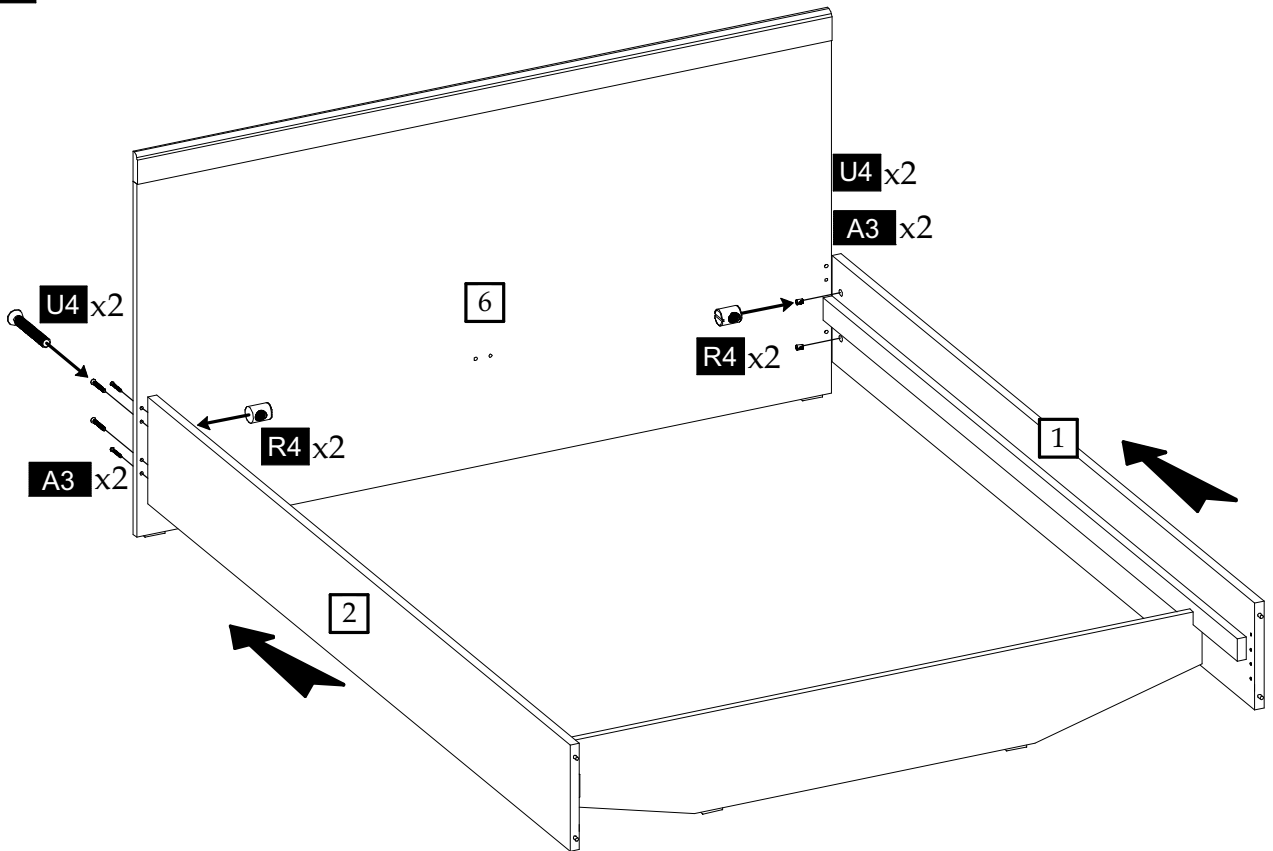

6

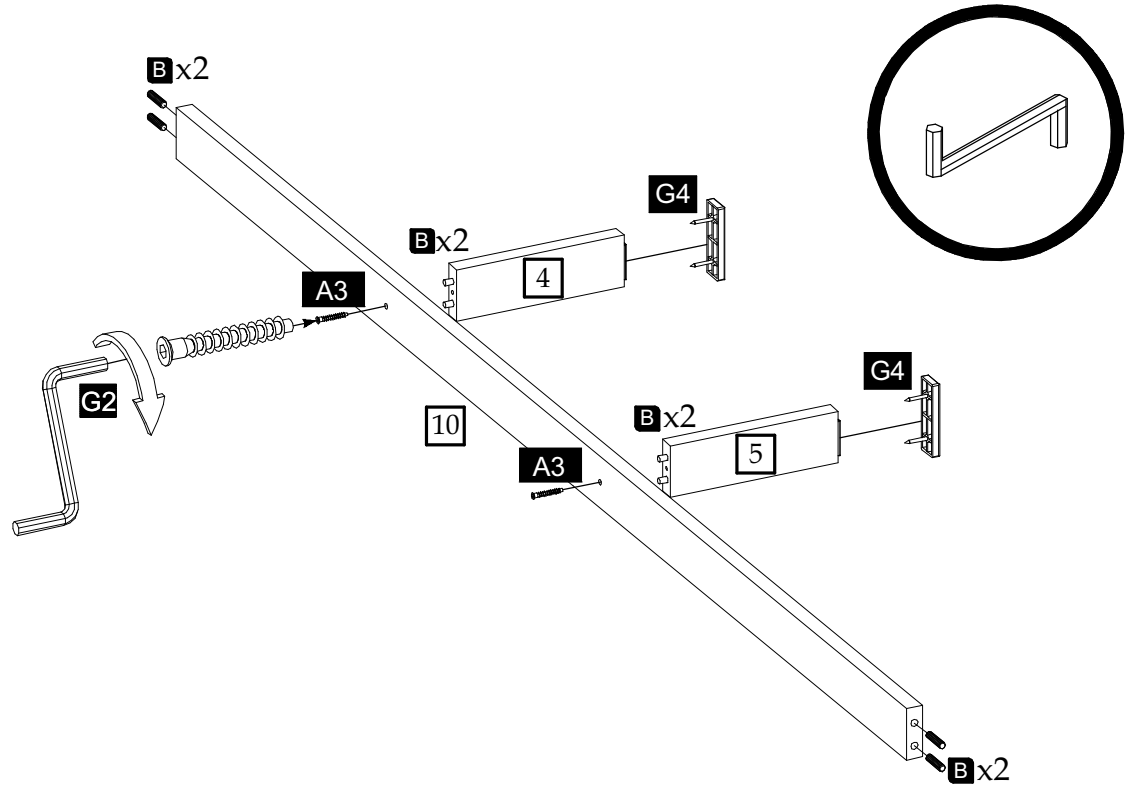

7

