

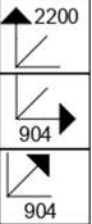

BETTY 02
BE02-016-00



V PRÍPADE REKLAMÁCIE JE POTREBNÉ NAHLÁSIŤ
VÝROBNÉ ČÍSLO VIDITEĽNÉ NA ETIKETE



A 130x	B 12x	C 48x	D 24x	E 12x	F 4x	G 16x	H 9x	J 21x	K 1x

L 4x	M 4x	P 2x



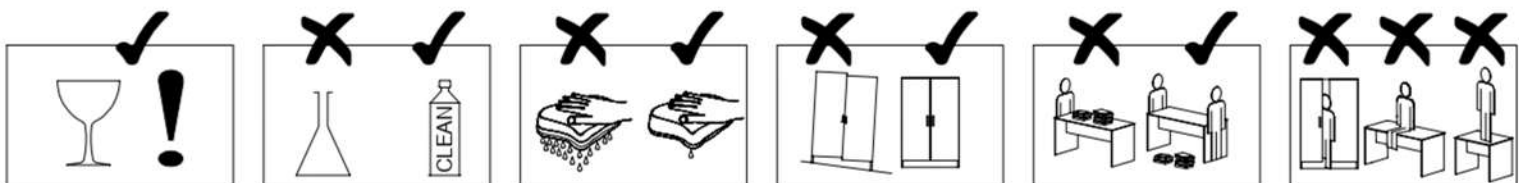
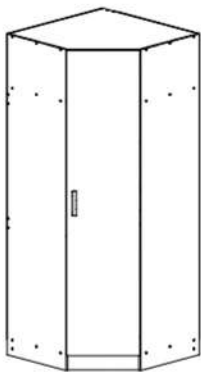
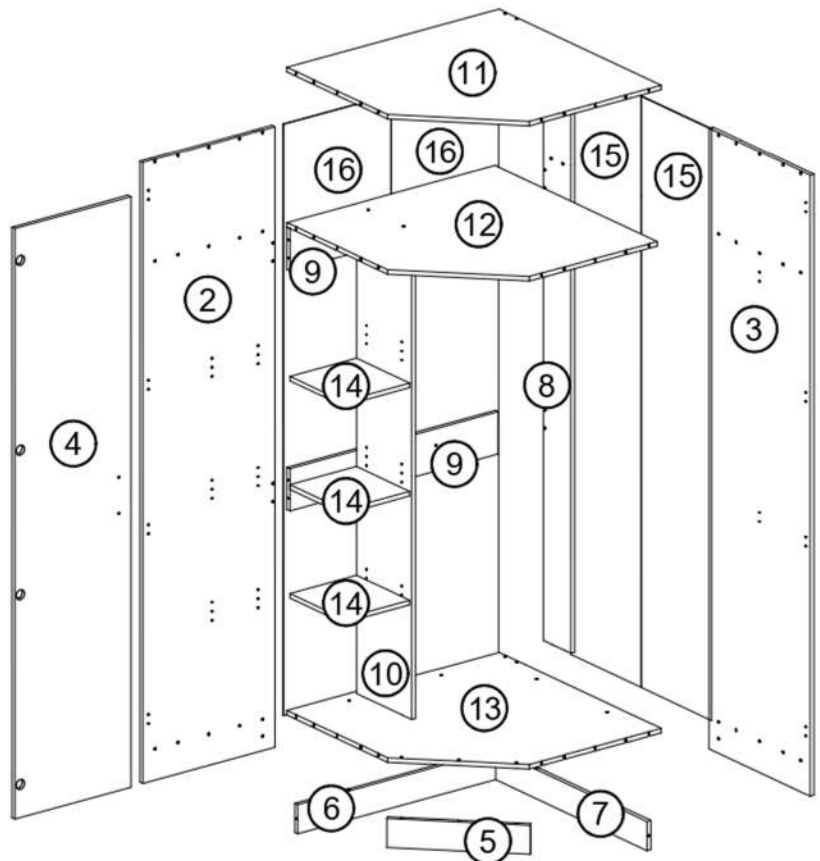

0h 50min	2	4	5,5 x 125	≤ 0,5 kg	0,6m	3m	

ID	ID	Icon	Dimensions	Qty	Ratio
01412	②		2200*550*16	1x	1/3
01413	③		2200*550*16	1x	1/3
01414	④		2092*472*16	2x	2/3
01415	⑤		103*478*16	1x	3/3
01416	⑥		825*103*16	1x	3/3
01417	⑦		841*103*16	1x	3/3
01418	⑧		2064*150*16	1x	2/3
01419	⑨		868*150*16	2x	3/3
01420	⑩		1712*300*16	1x	2/3
01421	⑪		884*884*16	1x	3/3
01422	⑫		868*884*16	1x	3/3
01423	⑬		884*884*16	1x	3/3
01424	⑭		278*290*16	3x	2/3 3/3
01425	⑮		2093*384*2,5	2x	1/3
01426	⑯		2093*448*2,5	2x	1/3

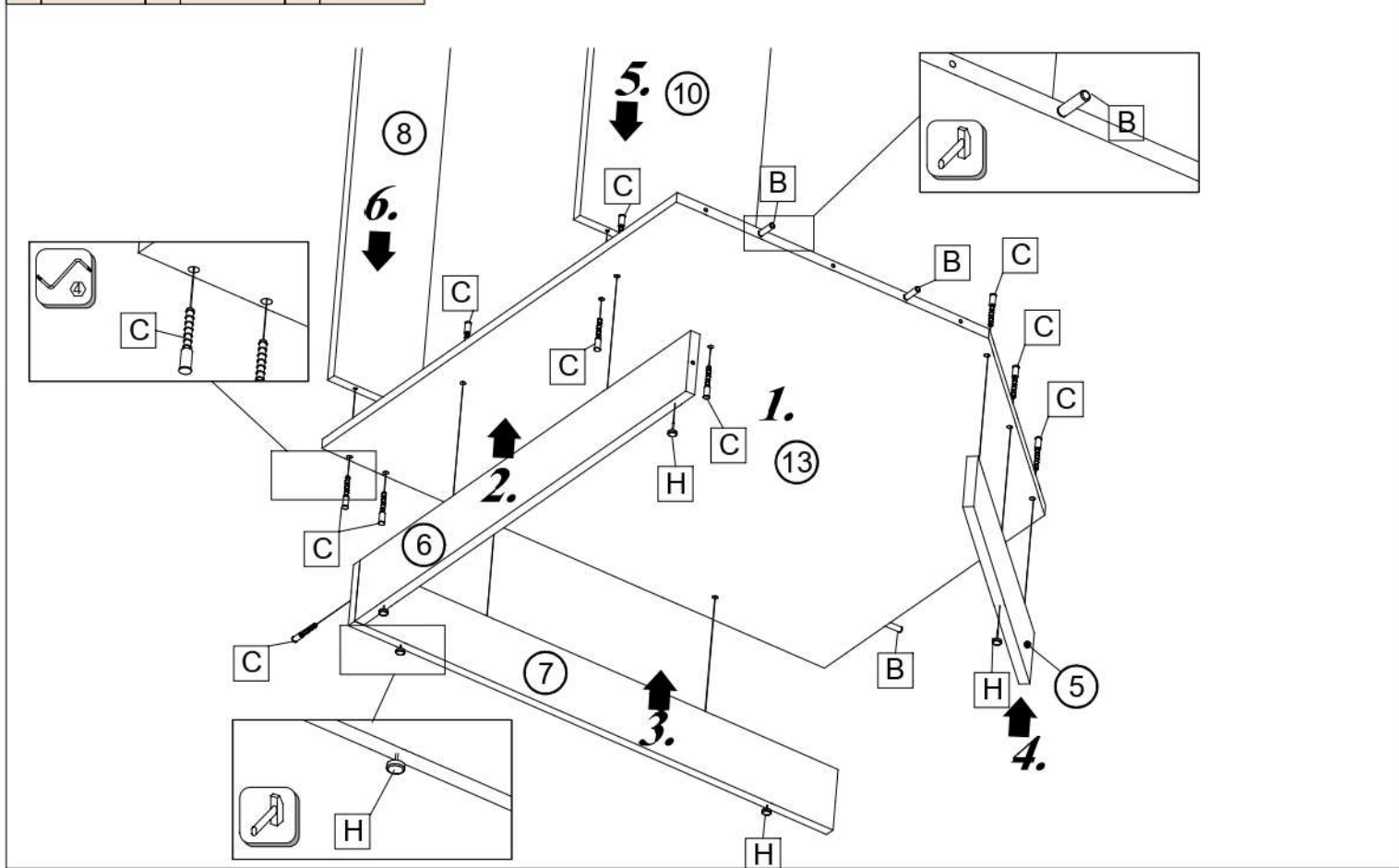





		
Ø8x30		
B 4x	C 12x	H 5x

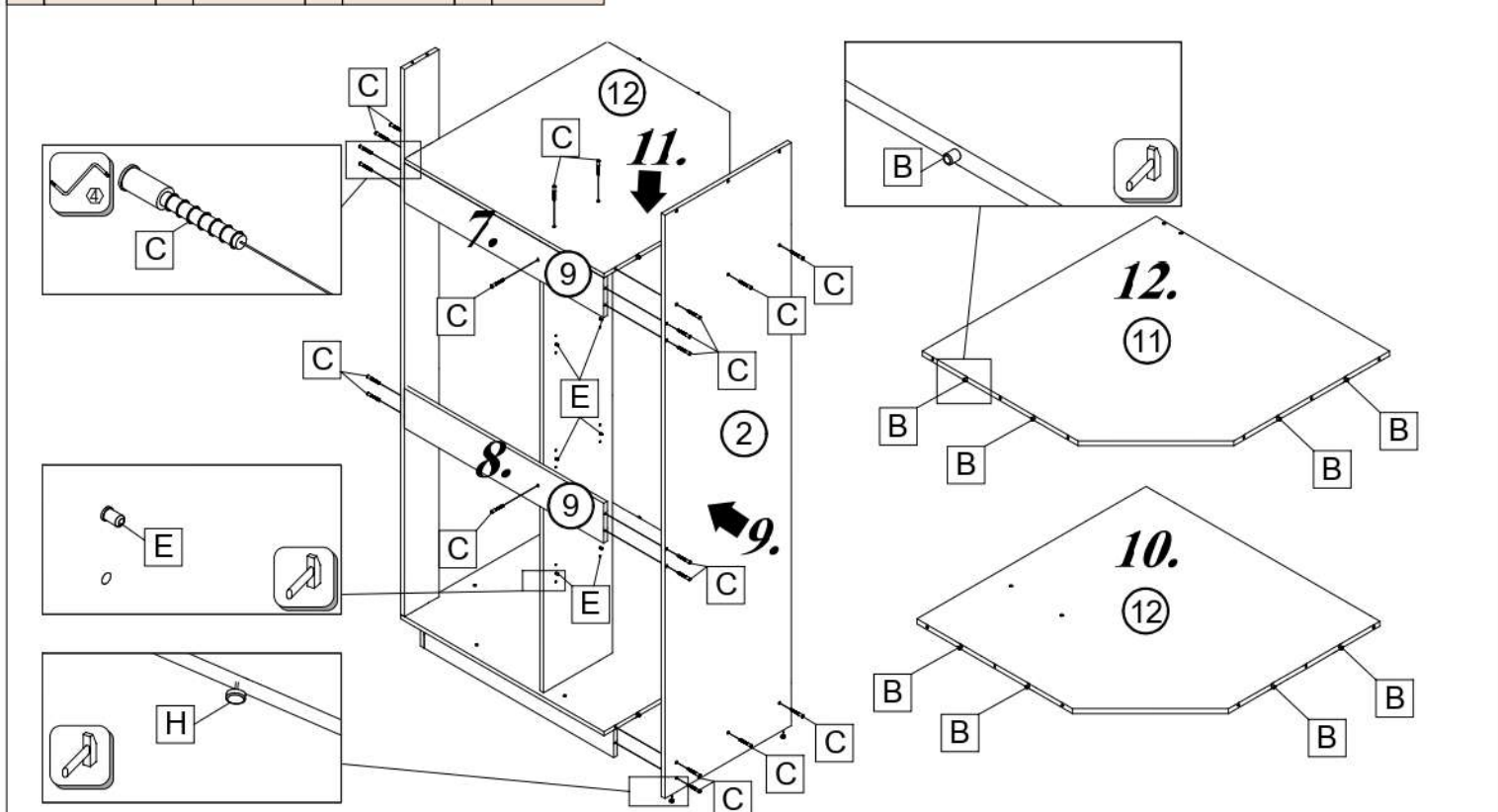

			
Ø8x30			
B 8x	C 21x	E 6x	H 2x





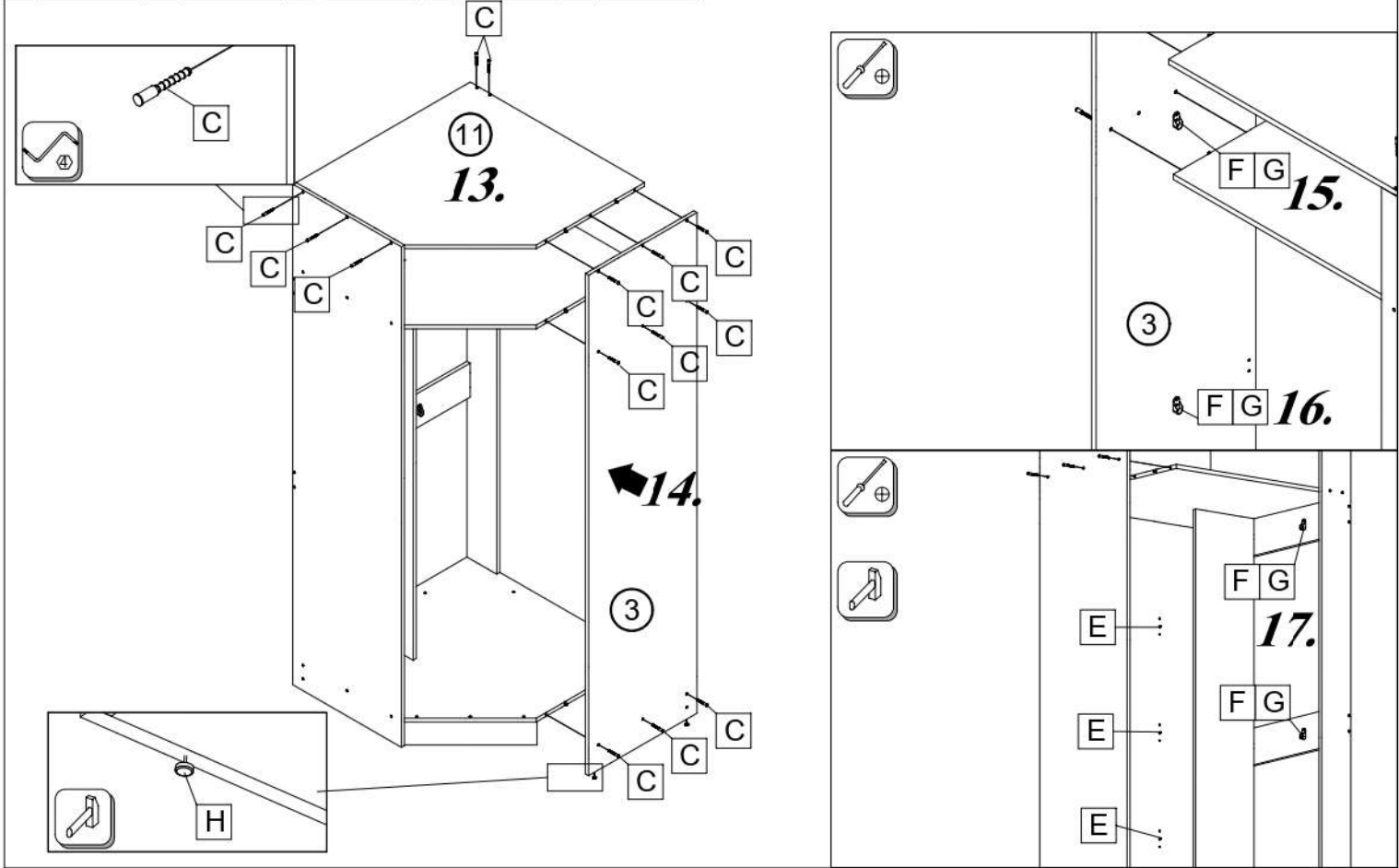

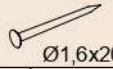
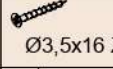
				
C 15x	E 6x	F 4x	G 8x	H 2x

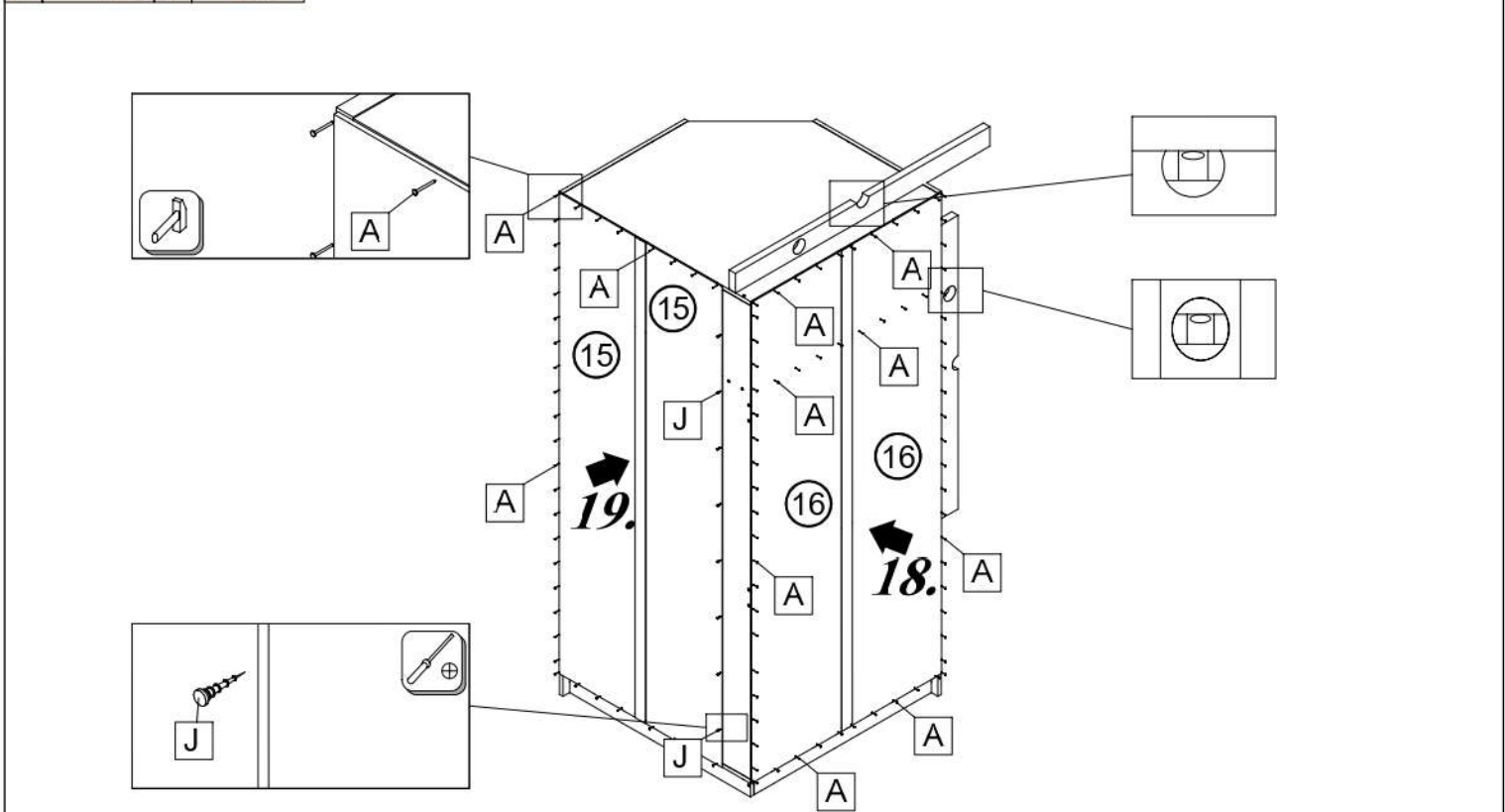

	
Ø1,6x20	Ø3,5x16 ZN
A 112x	J 21x



					
D 24x	K 1x	L 4x	M 4x	Ø3,5x15 ZN G 8x	P 2x

